

Measuring, control and sensor technology



ProMinent[®]

2018



Issued by:

ProMinent GmbH
Im Schuhmachergewann 5-11
69123 Heidelberg
Germany
Phone +49 6221 842-0
info@prominent.com
www.prominent.com



Technical changes reserved.

All previous catalogues and price lists are superseded with the release of this product catalogue.
You can view our general terms and conditions on our homepage.

Heidelberg, January 2018

Measuring, Control and Sensor Technology



Precision by design

Precise sensor technology and high-performance measuring and control technology are the guarantee of process safety when metering liquid media.

We deal with it in detail in **Chapter 1!** Discover a huge range of DULCOTEST® sensors for precise recording of different parameters in real time.

The controllers in **Chapter 2** will introduce consistent quality into your process. From the simple conversion of measuring signals to controllers optimised for complex, application-specific control tasks - the optimum product for every task awaits you here!

Completely assembled measuring and control points are described in **Chapter 3**. They are designed for the measurement of potable water, cooling water and waste water. The ready-wired plug-and-play modules, with perfectly matched components, are ready for fast and easy installation.

Chapter 4 is devoted to the treatment of swimming pool water. The product range DULCODOS® Pool is available for this. These complete **panel-mounted systems** are available in different models - for private pools to public swimming pools.

Ready for you. Anytime, anywhere.

ProMinent is close to hand no matter where you are: 55 dedicated sales, production and service companies guarantee service and availability in close proximity to our customers. For many years this has meant a local presence for our customers in over 100 countries.

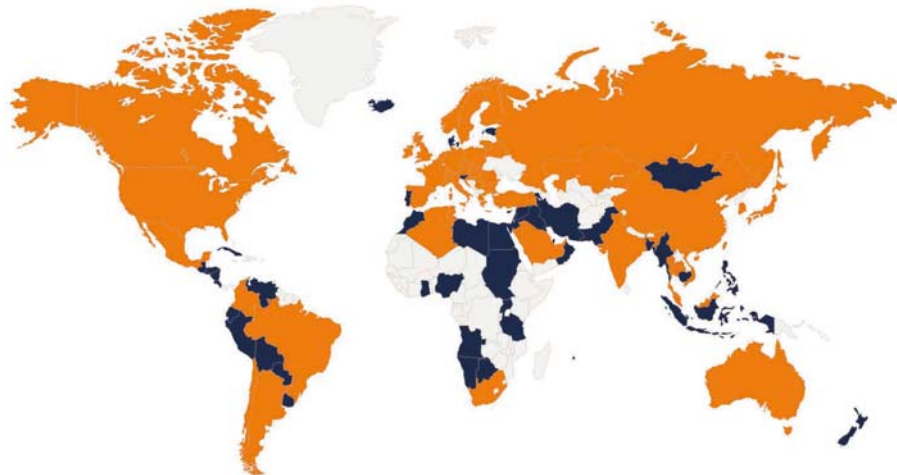

Our sales team will be happy to be of assistance should you have any questions about metering technology or water treatment. You will find the contact details of your local contact at www.prominent.com/en/locations.

Pump Guide

You can also find information online. The ProMinent pump selection guide is available on our website. Just enter the required pump capacity and back pressure, and the Pump Guide will show you a list of suitable metering pumps. This is the quick and easy way to track down precisely the right pump for your needs.

www.pump-guide.com

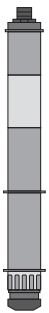

P_DT_0077_SW

Sensor for free chlorine CLO 1-CAN-P

Sensor for the measurement of free chlorine in clear water even when using electrolysis processes for disinfection, up to 45 °C (1 bar) or 8 bar (25 °C). For use on controllers with CAN-bus connection.

- Measured variable: free chlorine, no significant cross sensitivity to combined chlorine (chloramines)
- Use with return of the sample water to the process line
- Use at higher pressures
- Minimisation of faults by electrolysis systems in which the electrodes are immersed directly into the sample water (without diaphragm) by open sensor (no diaphragm) and gold electrodes
- Measurement of free chlorine up to pH 9

For more information see page → 1-57

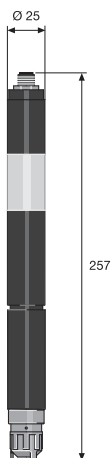

pk_6_084

Sensor for free and combined bromine BRE 1-CAN-P

Sensor for free chlorine and bromine in contaminated water, also suitable for high pH values of up to 9.5. For use on controllers with CAN-bus connection.

- Measured variable: free chlorine as well as free and combined bromine (bromamines)
- Diaphragm-covered sensor minimises faults caused by changing flow or ingredients in the water
- Resistance to films of dirt and biofilms by electrolyte with antimicrobial effect and large-pore diaphragm
- Use at high pH value of up to 9.5 by optimisation of the electrolyte diaphragm system

For more information see page → 1-62



New Measuring, Control and Sensor Technology Products

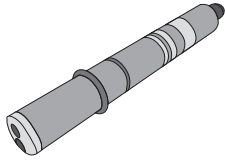

P_DT_0078_SW

Conductivity sensor CCT 1-mA

Sensor for the measurement of electrolytic conductivities for clear and also chemically contaminated water. With integrated temperature measurement and factory-calibrated 4...20 mA output signal. For operation with the controllers diaLog DAC, AEGIS® II, DULCOMARIN®.

- Measured variable: electrolytic conductivity up to 20 mS/cm
- Reliable 4-20 mA output signal for the flexible connection to different measuring devices
- Integrated temperature sensor for temperature compensation replaces separate temperature sensor and the corresponding sensor fitting

For more information see page → 1-111



Controller DULCOMETER® diaLog DACb

Transparent water analysis with the DULCOMETER® diaLog DACb – all combinations of relevant water treatment sensors can be freely evaluated and all actuators controlled.

- Lower investment costs: two measuring and control channels even in the basic version, each with independent monodirectional PID controller (two bidirectional PID controllers optional)
- Flexible selection and permits simple subsequent adjustments: 14 different measured variables per channel
- Ready for the world - offers 24 operating languages
- Transparency with troubleshooting: Event, calibration and measured data logger with easy-to-access SD memory card
- Ready for integration into your system by different field bus systems, like PROFIBUS®-DP, PROFINET® and Modbus RTU

For more information see page → 2-3



Measuring and control system DULCOMARIN® 3

The measuring and control system DULCOMARIN® 3 is your digital link to the technology of the future. It controls the entire range of swimming pools – from adventure pools to private pools. The system is operated using the large 7" touch display.

- Energy- and cost-efficient control of your swimming pool
- The DULCOMARIN® 3 can be accessed from every internet-compatible device
- Simple calibration of the sensors with video support
- Fast product selection and configuration of your system via web browser
- Status messages and alarm by e-mail
- View and assess the time-based course of the measured values of all pools on the built-in screen writer
- Simple, unrestricted LAN connection – like in your home network
- Subsequent extendibility due to the LAN-based bus system
- Intelligent chlorine sensors: save the sensor data and are always in the optimum measuring range with auto-ranging
- Intelligent metering pumps: provide information on operating parameters, such as chemical level statuses and pump capacity, within the range of 0.7 l/h to 1,000 l/h
- Coupling to a PLC Programmable Logic Controller via PROFIBUS® DP and Modbus RTU
- View historical measured data directly on the controller: enabled by the integral screen writer with data logger via USB

For more information see page → 2-74



Measuring, Control and Sensor Technology		page
1	Sensor Technology DULCOTEST®	1-1
1.0	Overview of Sensor Technology DULCOTEST®	1-1
1.0.1	Selection Guide	1-1
1.1	Sensor Technology DULCOTEST® Measuring Principles	1-5
1.1.1	Three Measurement Principles for Reliable Water Treatment	1-5
1.1.2	Potentiometry - Measures an Electrode's Potential in a Sample Solution	1-5
1.1.3	Amperometry - A Current Measurement Used to Determine the Concentration of Predetermined Dissolved Solids in Aqueous Solutions	1-6
1.1.4	Advantages of DULCOTEST® Amperometric Sensors at a Glance	1-7
1.1.5	Conductometry – The Measurement of Electrolytic Conductivity	1-8
1.2	pH, ORP, Fluoride and Temperature Sensors DULCOTEST®	1-9
1.2.1	pH Sensors With SN6 or Vario Pin Plug-In Head	1-11
1.2.2	pH Sensors with Fixed Cable	1-29
1.2.3	ORP Sensors with SN6 Plug-in Head	1-34
1.2.4	ORP Sensors with Fixed Cable	1-44
1.2.5	DULCOTEST® Fluoride Sensors	1-46
1.2.6	DULCOTEST® Temperature Sensors	1-47
1.3	Amperometric Sensors DULCOTEST®	1-48
1.3.1	Amperometric Sensors for Chlorine, Bromine, Chlorine Dioxide, Chlorite, Ozone, Dissolved Oxygen, Peracetic Acid and Hydrogen Peroxide	1-48
1.3.2	Sensors for Chlorine	1-50
1.3.3	DULCOTEST® Sensors for Free Chlorine	1-52
1.3.4	DULCOTEST® Sensors for Total Available Chlorine	1-65
1.3.5	DULCOTEST® Sensors for Total Chlorine	1-67
1.3.6	DULCOTEST® Sensors for Bromine	1-70
1.3.7	DULCOTEST® Sensors for Chlorine Dioxide	1-75
1.3.8	DULCOTEST® Sensors for Chlorite	1-79
1.3.9	DULCOTEST® Sensors for Ozone	1-81
1.3.10	DULCOTEST® Sensors for Dissolved Oxygen	1-83
1.3.11	DULCOTEST® Sensors for Peracetic Acid	1-86
1.3.12	DULCOTEST® Sensors for Hydrogen Peroxide	1-87
1.4	DULCOTEST® Conductivity Sensors	1-90
1.4.1	Conductivity Sensors	1-90
1.4.2	2-Electrode Conductivity Sensors	1-93
1.4.3	Inductive Conductivity Sensors	1-114
1.5	Turbidity Measuring Points DULCOTEST®	1-120
1.5.1	Turbidity Measuring Point DULCOTEST® DULCO® turb C	1-120
1.6	Accessories Sensor Technology	1-122
1.6.1	Sensor Accessories	1-122
1.6.2	Consumable Items for Sensors	1-125
1.6.3	Bypass Fittings for Sensors	1-128
1.6.4	Immersion Fittings for Sensors	1-132
1.6.5	Installation Fittings / Adapters	1-136
1.7	Application Examples	1-140
2	Measuring and Control Technology	2-1
2.0	Measuring and Control Units DULCOMETER®	2-1
2.0.1	Measuring and Control Units DULCOMETER®	2-1
2.1	Controller DULCOMETER® diaLog DACb	2-3
2.1.1	Controller DULCOMETER® diaLog DACb	2-3
2.1.2	Identity Code Ordering System for diaLog DACb, Wall Mounting IP 67	2-7
2.1.3	Retrospective function extension for the diaLog DACb measuring and control system	2-8
2.1.4	DACb application and ordering examples	2-9
2.1.5	Application Examples, Treatment of Swimming Pool Water	2-10
2.1.6	Application Examples, Potable Water Monitoring	2-12



Measuring, Control and Sensor Technology

page

	2.1.7	Application Examples, Waste Water Monitoring	2-15
	2.1.8	Application Examples in the Food Industry	2-17
	2.1.9	Odour Reduction Application Examples (Clarification Plants)	2-18
2.2		Controller DULCOMETER® D1Cb/D1Cc	2-19
	2.2.1	Controller DULCOMETER® D1Cb/D1Cc	2-19
	2.2.2	Identity Code Ordering System DULCOMETER® D1Cb, Wall Mounting	2-21
	2.2.3	Identity Code Ordering System DULCOMETER® D1Cc, Control Panel Mounting	2-22
	2.2.4	D1Ub Identity Code Ordering System, Subsequent Function Upgrade for D1Cb	2-24
	2.2.5	D1Uc Identity Code Ordering System, Subsequent Function Upgrade for D1Cc	2-25
	2.2.6	D1Cb and D1Cc Application and Ordering Examples	2-26
	2.2.7	Application Examples, Treatment of Swimming Pool Water	2-27
	2.2.8	Application Examples, Potable Water Monitoring	2-29
	2.2.9	Application Examples, Waste Water Monitoring	2-31
	2.2.10	Application Examples in the Food Industry	2-32
2.3		Controller DULCOMETER® Compact	2-33
	2.3.1	Controller DULCOMETER® Compact	2-33
	2.3.2	Identity Code Ordering System DULCOMETER® Compact, Wall Mounting IP 67	2-35
	2.3.3	Application and Ordering Examples for the DULCOMETER® Compact	2-36
	2.3.4	Application Examples, Treatment of Swimming Pool Water	2-36
	2.3.5	Application Examples, Potable Water Monitoring	2-38
	2.3.6	Application Examples, Waste Water Monitoring	2-39
2.4		Multi-Channel Multi-Parameter Measuring and Control System DULCOMARIN® II	2-40
	2.4.1	Measuring and control system DULCOMARIN® 3	2-40
	2.4.2	Measuring and control system DULCOMARIN® 3	2-43
	2.4.3	Identity Code Ordering System DULCOMARIN® II	2-47
	2.4.4	Multi-Channel Multi-Parameter Measuring and Control System DULCOMARIN® II	2-49
	2.4.5	Central Unit	2-51
	2.4.6	Combination Module	2-52
	2.4.7	DULCOMARIN® 3 functional module (F-module)	2-53
	2.4.8	Identity Code Ordering System Multi-Channel Multi-Parameter Measuring and Control System DULCOMARIN® II (Central Unit and Combination Module)	2-54
	2.4.9	Measuring Module (M module)	2-56
	2.4.10	Current Input Module (I module)	2-58
	2.4.11	Control Module (A module)	2-59
	2.4.12	Power Supply Module (N module)	2-60
	2.4.13	Control Module for Chlorine Gas Metering Devices (R module)	2-61
	2.4.14	Limit Value and Alarm Module (G module)	2-62
	2.4.15	Identity Code Ordering System for CANopen Modules	2-63
	2.4.16	Spare Parts and Upgrade Sets	2-64
	2.4.17	Retrofit Kits for DULCOMARIN® II DXC	2-65
	2.4.18	Diaphragm Metering Pumps with CANopen Bus Interface	2-66
	2.4.19	Solenoid-Driven Metering Pumps Beta®	2-67
	2.4.20	Multi-Channel Measuring and Control System DULCOMARIN® II, Module Combinations	2-70
	2.4.21	Configuration Example 1	2-71
	2.4.22	Configuration Example: 2-Pool System	2-73
	2.4.23	Accessories for the DULCOMARIN® measuring and control system	2-75
2.5		DULCOMARIN® 3 multi-channel multi-parameter measuring and control system for water treatment	2-79
	2.5.1	Measuring and control system DULCOMARIN® 3	2-79
	2.5.2	Measuring and control system DULCOMARIN® 3	2-81
	2.5.3	Identity code ordering system for DULCOMARIN® 3	2-84



Measuring, Control and Sensor Technology

page

	2.5.4	Chlorine sensors for DULCOMARIN® II and 3	2-85
2.6		Controller AEGIS II	2-86
	2.6.1	Controller AEGIS II	2-86
	2.6.2	Identity code ordering system for AEGIS II cooling tower control	2-88
2.7		Controller with Integral Metering Pump	2-90
	2.7.1	Controller with Integral Metering Pump	2-90
2.8		DULCOMETER® Transmitters	2-91
	2.8.1	Transmitter DULCOMETER® DMTa	2-91
	2.8.2	Identity Code Ordering System for Transmitter DMTa	2-93
	2.8.3	Application Example: Measurement of Free Chlorine with Connection to a PLC	2-94
	2.8.4	Transmitter DULCOMETER® DULCOPAC	2-95
	2.8.5	Application Examples for DULCOPAC	2-97
2.9		Measuring and Test Systems	2-98
	2.9.1	Portable Meter Portamess® – Measured Variable pH/ORP	2-98
	2.9.2	Portable Meter Portamess® – Measured Variable Conductivity	2-99
	2.9.3	Photometer	2-101
2.10		Accessories for Measuring and Control Devices	2-104
	2.10.1	Transmitter 4 ... 20 mA (Two-Wire System)	2-104
	2.10.2	Accessories for Portable Meters Portamess®	2-107
3		Panel-Mounted Measuring/Control Stations	3-1
3.0		Overview of Ordering System for Measuring and Control Points DULCOTROL® DWCa	3-1
	3.0.1	Selection Guide	3-1
	3.0.2	Description of the Identity Code Specifications in the DULCOTROL® DWCa Ordering System	3-1
3.1		Measuring and Control Points DULCOTROL® DWCa_P Potable Water/F&B	3-3
	3.1.1	Overview of DULCOTROL® DWCa_Potable Water/F&B	3-3
	3.1.2	Permissible measured variable combinations for DULCOTROL® DWCa_P Potable water/F&B	3-4
	3.1.3	Identity Code Ordering System for DULCOTROL® DWCa_P Potable Water/F&B	3-5
	3.1.4	Examples of DULCOTROL® DWCa_P Potable Water/F&B	3-7
3.2		Measuring and Control Points DULCOTROL® DWCa_W Waste Water	3-9
	3.2.1	Overview of DULCOTROL® DWCa_W Waste Water	3-9
	3.2.2	Permissible measured variable combinations for DULCOTROL® DWCa_W Waste water	3-10
	3.2.3	Identity Code Ordering System for DULCOTROL® DWCa_W Waste Water	3-11
	3.2.4	Examples of DULCOTROL® DWCa_W Waste Water	3-13
3.3		Technical Description of the Scope of Delivery of Measuring and Control Points DULCOTROL® DWCa	3-15
	3.3.1	Technical Description of Controllers	3-15
	3.3.2	Technical Description of Sensors	3-16
	3.3.3	Technical Description of Sensor Fittings	3-18
	3.3.4	Technical Description of the Hydraulic Connector/Pipework	3-19
	3.3.5	Technical Description of Optional Accessories	3-20
4		Measuring Control and Metering Systems for Swimming Pool Water Treatment	4-1
4.0		Measuring Control and Metering Systems for Swimming Pool Water Treatment	4-1
	4.0.1	DULCODOS® Pool Swimming Pool Metering Systems	4-1
4.1		Metering System DULCODOS® Pool Soft	4-3
	4.1.1	Metering System DULCODOS® Pool Soft	4-3
4.2		Metering System DULCODOS® Pool Basic	4-5
	4.2.1	Metering System DULCODOS® Pool Basic	4-5
4.3		Metering System DULCODOS® Pool Comfort	4-7
	4.3.1	Metering System DULCODOS® Pool Comfort	4-7



Measuring, Control and Sensor Technology		page
4.4	Metering System DULCODOS® Pool Professional	4-9
4.4.1	Metering System DULCODOS® Pool Professional	4-9
4.5	Maintenance Kits	4-13
4.5.1	Maintenance Kits for Metering Pumps	4-13
4.5.2	Maintenance Kits for Measured Variables	4-13
4.5.3	Buffer Solutions	4-13
4.6	Test Equipment	4-14
4.6.1	Portable Meter Portamess® – Measured Variable pH/ORP	4-14
4.6.2	Photometer	4-15
5	ProMinent® Chemical Resistance List	



1.0 Overview of Sensor Technology DULCOTEST®

1.0.1 Selection Guide

Selection Guide for pH Sensors DULCOTEST®

Medium	Temperature / pressure	Sensor type	Typical application
clear, pH 3 – 14	max. 100 °C / 3 bar	PHEP-H	Chemical processes
	max. 25 °C / 6 bar		
Clear, pH 2 – 12	max. 80 °C / no overpressure	PHEN	Chemically contaminated water, low-conductivity water $\geq 50 \mu\text{S/cm}$
	max. 60 °C / 3 bar	PHEP	Swimming pool water, potable water, glass stem
		PHEK	Swimming pool, aquarium, plastic shaft
	max. 80 °C / 6 bar	PHEP/PHEPT	Process water
	max. 80 °C / 8 bar	PHED	Chemically contaminated water, e.g. Cr^{6+} , CN^-
Solid residues, turbidity	max. 80 °C / 6 bar	PHER/PHEI	Cooling water, waste water
Solid matter, non-translucent	max. 100 °C / 16 bar	PHEX	Suspensions, sludge, emulsions
Clear to turbid, containing fluoride, pH 0 - 7	max. 50 °C / 7 bar	PHEF	Exhaust air scrubber, semiconductor industry, electroplating

DULCOTEST® ORP sensor selection guide

Medium	Temperature / pressure	Sensor type	Typical application
Clear, pH 2 – 12	max. 80 °C / no overpressure	RHEN	Chemically contaminated water, low-conductivity water $\geq 50 \mu\text{S/cm}$
	max. 60 °C / 3 bar	RHES	Swimming pool water, potable water, glass stem
		RHEK	Swimming pool, aquarium, plastic shaft
	max. 80 °C / 6 bar	RHEP-Pt	Process water
		RHEP-Au	Chemically contaminated water, e.g. CN^- , ozone treatment
Solid residues, turbidity	max. 80 °C / 6 bar	RHER	Cooling water, waste water
Solid matter, non-translucent	max. 100 °C / 16 bar	RHEX	Suspensions, sludge, emulsions

Note: All DULCOTEST® pH and ORP sensors are made using lead-free glass (RoHS-compliant)



1.0 Overview of Sensor Technology DULCOTEST®

Selection guide for DULCOTEST® amperometric sensors

Measured variable	Applications	Graduated measuring range	Connection to DULCOMETER®	Sensor type	See page
Free chlorine	Potable water, swimming pools	0.01–100 mg/l	D1C, DAC	CLE 3-mA-xppm, CLE 3.1-mA-xppm	→ 1-51
Free chlorine	Process and waste water	10 - 200 mg/l	D1C, DAC	CLR 1-mA	→ 1-63
Free chlorine	Potable water, swimming pool water	0.01 - 10 mg/l	DULCOMARIN®	CLE 3-CAN-xppm, CLE 3.1-CAN-xppm	→ 1-54
Free chlorine	Potable water, swimming pool water, in situ electrolysis (without diaphragm)	0.02-10 mg/l	D1C, DAC	CLO 2-mA-2ppm	→ 1-56
Free chlorine	Swimming pools, uncontaminated potable water and process water, and can also be used together with diaphragm-free electrolysis processes.	0.01-10 mg/l	DULCOMARIN®	CLO 2-mA-2ppm	→ 1-57
Free chlorine	Hot water up to 70 °C (legionella), in situ electrolysis (without diaphragm)	0.02-2 mg/l	D1C, DAC	CLO 2-mA-2ppm	→ 1-58
Free chlorine	Potable water, swimming pools	0.01–50 mg/l	DMT	CLE 3-DMT-xppm	→ 1-53
Free chlorine	Potable water, swimming pools	0.05-5 mg/l	COMPACT	CLB 2-µA-xppm	→ 1-59
Free chlorine	Potable water, swimming pool water	0.05-5 mg/l	COMPACT	CLB 3-µA-xppm	→ 1-60
Free chlorine	Cooling, industrial and waste water, water with higher pH values (stable); seawater (free chlorine exists as bromine)	0.01-10 mg/l	D1C, DAC	CBR 1-mA-xppm	→ 1-61
Total available chlorine	Swimming pool water with chlorine-organic disinfectants	0.02–10 mg/l	D1C, DAC	CGE 3-mA-xppm	→ 1-64
Total available chlorine	Swimming pool water with organic chlorine disinfectants, in situ electrolysis (without diaphragm)	0.02 - 10 mg/l	D1C, DAC	CGE 3-mA	→ 1-64
Total available chlorine	Swimming pool water with chlorine-organic disinfectants	0.01–10 mg/l	DULCOMARIN®	CGE 3-CAN-P-xppm	→ 1-65
Total chlorine	Potable, industrial, process and waste water	0.01–10 mg/l	D1C, DAC	CTE 1-mA-xppm	→ 1-66
Total chlorine	Potable, industrial, process and waste water	0.01–10 mg/l	DMT	CTE 1-DMT-xppm	→ 1-67
Total chlorine	Potable, industrial, process and waste water	0.01–10 mg/l	DULCOMARIN®	CTE 1-CAN-P-xppm	→ 1-68
Combined chlorine	Swimming pool water	0.02–2 mg/l	DAC	CTE 1-mA-2 ppm + CLE 3.1-mA-2 ppm	→ 1-68
Combined chlorine	Swimming pool water	0.01–10 mg/l	DULCOMARIN®	CTE 1-CAN-P-xppm + CLE 3.1-CAN-xppm	→ 1-68
Total available bromine	Cooling water, waste water, swimming pool water, whirlpool water, bromine with BCDMH	0.01-10 mg/l	D1C, DAC	BCR 1-mA (replaces earlier type BRE 1)	→ 1-70
Total available bromine	Cooling water, swimming pool water, whirlpool water with organic or inorganic bromine compounds	0.02-10 mg/l	DULCOMARIN®	BRE 3-CAN-10 ppm	→ 1-71
Free and bound bromine	Cooling, industrial, waste water, water with higher pH values (stable); seawater	0.02-20 mg/l	D1C, DAC	CBR 1-mA-xppm	→ 1-61
Free + combined bromine	Cooling, industrial, waste water, water with higher pH values (stable); sea water	0.00-0 mg/l	D1C, DAC	CBR 1-mA-xppm	→ 1-62
Chlorine dioxide	Potable water	0.01–10 mg/l	D1C, DAC	CDE 2-mA-xppm	→ 1-74
Chlorine dioxide	Bottle washer systems	0.02–2 mg/l	D1C, DAC	CDP 1-mA	→ 1-75
Chlorine dioxide	Hot water up to 60 °C, cooling water, waste water, irrigation water	0.01-10 mg/l	D1C, DAC, DULCOMARIN®	CDR 1-mA-xppm, CDR 1-CAN-xppm	→ 1-76
Chlorite	Potable, wash water	0.02–2 mg/l	D1C, DAC, DULCOMARIN®	CLT 1-mA-xppm, CLT 1-CAN-xppm	→ 1-78
Ozone	Potable water, swimming pool water	0.02–2 mg/l	D1C, DAC	OZE 3-mA	→ 1-80
Ozone	Process, service or cooling water	0.02–2 mg/l	D1C, DAC	OZR 1-mA-2 ppm*	→ 1-81
Dissolved oxygen	Potable, surface water	2–20 mg/l	D1C, DAC	DO 1-mA-xppm	→ 1-82
Dissolved oxygen	Activated sludge tank, sewage treatment plants	0.1–10 mg/l	D1C, DAC	DO 2-mA-xppm	→ 1-83
Peracetic acid	CIP, antiseptic food filling process	1–2,000 mg/l	D1C, DAC	PAA 1-mA-xppm	→ 1-84
Hydrogen peroxide	Clear water, fast control	1–2,000 mg/l	DAC	PEROX sensor PEROX-H2.10 P	→ 1-86
Hydrogen peroxide	Process, swimming pool water	2–20.000 mg/l	D1C, DAC	PER1-mA-xppm	→ 1-86



1.0 Overview of Sensor Technology DULCOTEST®

Conductivity sensor selection guide

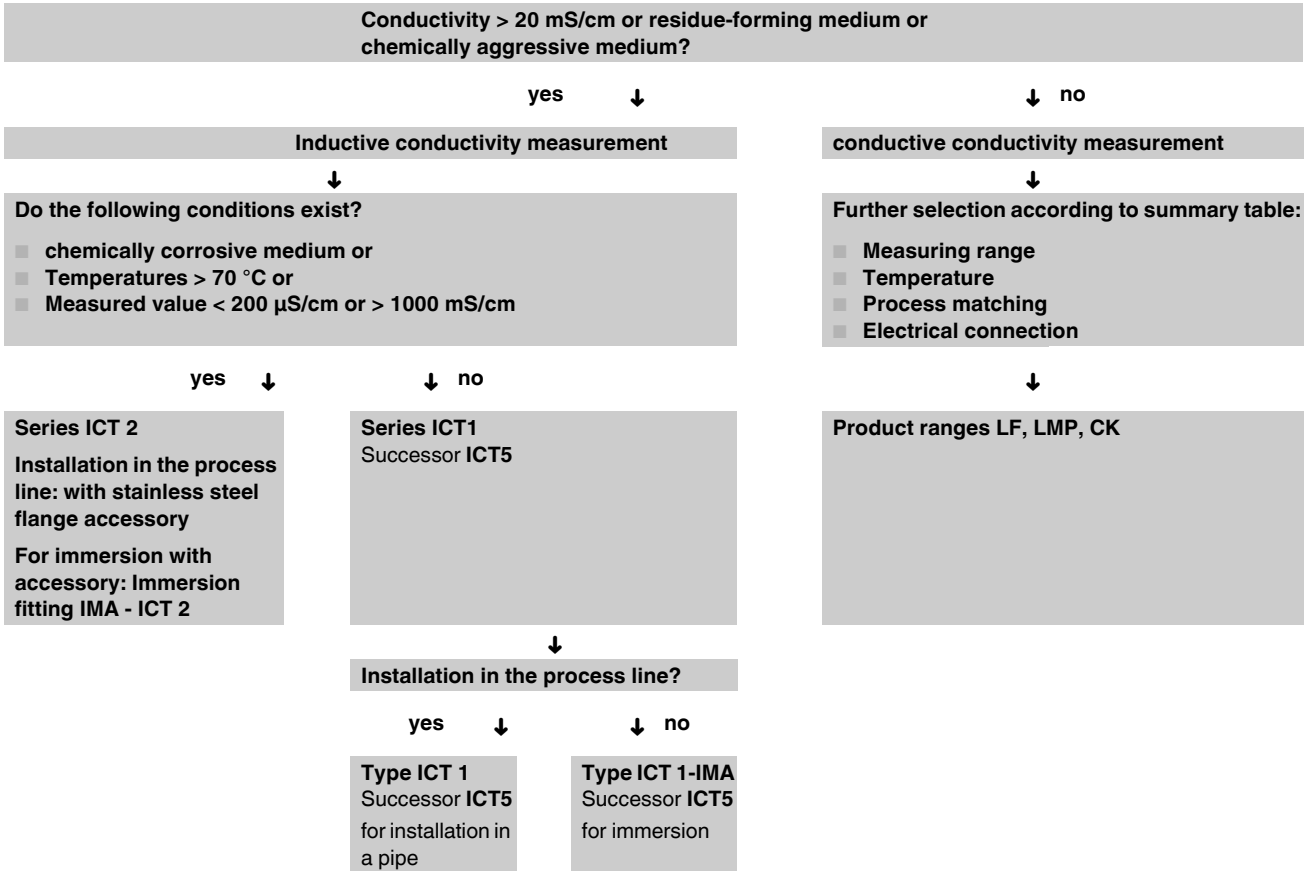

1.1 Sensor Technology DULCOTEST® Measuring Principles

1.1.1 Three Measurement Principles for Reliable Water Treatment

- Potentiometry is used to determine: pH value, ORP and fluoride concentration
- Amperometry is used to determine: chlorine, bromine, chlorine dioxide, ozone, hydrogen peroxide, peracetic acid
- Conductometry is used to determine electrolytic conductivity

1.1.2 Potentiometry - Measures an Electrode's Potential in a Sample Solution

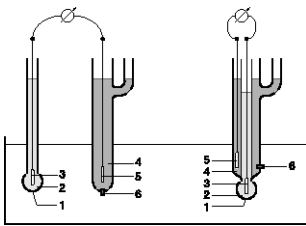

pk_6_001

- 1 Glass membrane
- 2 Internal pH buffer
- 3 Internal derivation
- 4 Electrolyte
- 5 External derivation
- 6 Diaphragms

As the measurement of the potential of a sensor (half chain) is not possible, a measuring chain is used that comprises two half chains. Their potential difference can be measured using a very high resistance voltmeter, i.e. nearly without any current.

A measuring chain always comprises:

A measuring electrode, which reacts as specifically as possible to concentration changes for a particular reactant and a reference electrode (reference), which supplies, as constantly as possible, a voltage that is dependent on the concentration of the reactant.

An example of a measuring system, such as this, is the pH measuring sensor, designed as a two-rod sensor or single rod sensor (Fig. pk_6_001).

pH = -log a_{H+}

As hydrogen ion concentrations occur in a wide range of less than 10⁻¹⁴ g/l up to more than 10 g/l (or mol/l) in aqueous solutions and the exponential nomenclature is unwieldy, the pH scale is defined as:

pH = -log a_{H+}

For concentrations that are not too high, activity and concentration can be set equally.

Then a concentration of 10⁻¹⁴ corresponds to a pH value of 14 and a concentration of 10⁰ = 1 corresponds to a pH value of 0.

pH value 7 is identified as neutral. This means that the effective concentrations of H⁺ and OH⁻ ions here, which originate from the dissociation of water (H₂O → H⁺ + OH⁻), are the same size.

If the hydrogen ions are in a majority due to the addition of acid (e.g. HCl) then the pH values are less than 7. If a base (alkali) is added (e.g. NaOH) then the values are greater than 7 and the solution becomes alkaline.

Each change in the pH value by 1 corresponds to a factor of 10 concentration change and results from the logarithmic relationship.

Fig. pk_6_002 shows the theoretical voltage curve for pH glass electrodes. In practice glass electrodes exhibit a greater or lesser deviation from the theoretical curve.

The electrode system generally exhibits a zero-point deviation (asymmetry potential), which is smaller than ± 0.5 pH, however. The electrode slope (mV/pH) may also deviate from the theoretical value U_N (59.2 mV/pH at 25 °C), which is particularly the case for used glass electrodes.

Other deviations occur at very low pH values, the so-called acid error, while at high pH values allowance must be made for the so-called alkali error (or Na error).

pH measuring amplifiers must be matched to the respective measuring chain by means of zero point and slope calibration

Here the zero point is calibrated using a buffer solution, the value of which is about pH 7 while the slope is calibrated using a buffer in an acidic or alkaline range that has a pH value 2 or 3 above or below the neutral point.

With pH measurements that differ from pH 7, the fluctuating temperature of the measuring medium may result in a need for temperature compensation.

In this respect three questions must be answered:

- 1 What pH value is to be measured?
- 2 How large are the temperature deviations?
- 3 How accurate must the measurements be?

Example of the influence of temperature without compensation:

At pH 10, an incorrect indication of approximately + 0.1 pH occurs for a temperature increase of about 10 °C. This effect is greater the greater the pH value differs from pH 7.

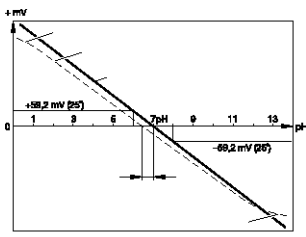

pk_6_002

- 1 Acid error
- 2 Exponential (in practice)
- 3 Theoretical (nominal slope)
- 4 Zero point deviation (asymmetrical potential)
- 5 Alkali error
- 6 Voltage of probe



1.1 Sensor Technology DULCOTEST® Measuring Principles

Measurement of the redox voltage is also a potentiometric measurement

The term "redox" (or ORP - oxidation/reduction potential) stands for the reduction and oxidation that occur alongside each other in aqueous solutions. In general, oxidation involves the removal of electrons with an oxidising agent acting as an electron acceptor. Reduction is the opposite with electrons being taken up, with the reducing agent acting as an electron donor.

The redox voltage is measured with a precious metal electrode, generally platinum. In an oxidising agent containing liquid (e.g. chlorine) there is a positive redox voltage, in a reducing agent (e.g. sodium bisulphite) a negative redox voltage.

The level of the redox voltage gives an indication of how strongly oxidising or reducing a solution is. Where disinfection is concerned, the redox voltage gives an indication of how great the germicidal effect of, for example, chlorine or ozone is.

Consequently the redox voltage can be considered as a hygiene parameter in water treatment.

It should be noted that the redox voltage varies with the pH value so that qualitative conclusions need to be made at a constant pH value.

Examples of typical applications for redox measurements

- Cyanide detoxification at a high pH value by oxidation using gold electrodes.
- Chromate detoxification at a low pH value by oxidation using platinum electrodes.
- Monitoring of the disinfection effect during oxidising agent metering (chlorine/bromine) using platinum electrodes.

1.1.3

Amperometry - A Current Measurement Used to Determine the Concentration of Predetermined Dissolved Solids in Aqueous Solutions

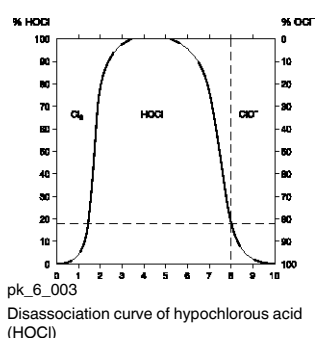

This type of current measurement concentrates on the nA (10^{-9} A) or μ A (10^{-6} A) range. Open or diaphragm-covered 2 or 3-probe sensors are used with operating measurements in this range. The amperometric sensor product range makes determining the concentration of chlorine, bromine, chlorine dioxide, chlorite, ozone, hydrogen peroxide, peracetic acid and dissolved oxygen possible.

Our amperometric DULCOTEST® sensors represent proven diaphragm-covered 2-probe sensors.

By separation of the electrode chamber from the measurement medium using a special diaphragm, clear metrological conditions are created and disturbing influences excluded.

ProMinent DULCOTEST® 2-probe sensors use gold or platinum as the working electrode (cathode). The counter electrode (anode) is silver with a special coating.

In contrast to open, fault-prone sensors, membrane-covered sensors exhibit hardly any flow dependency above a minimum flow (approx. 30 l/h). Consequently there is no need for costly measures to maintain the flow at a constant rate.

The pH value has a decisive influence on the chlorine measurement

It is important to know, in what forms chlorine is present in aqueous solutions. It is only at a very low pH value that chlorine occurs as dissolved chlorine gas Cl_2 in water and above a pH of about 3 as hypochlorous acid HOCl, which upon the further increase in the pH value dissociates into hypochlorite (see Fig. pk_6_003).

Compared with hypochlorous acid, hypochlorite is about 100 times less powerful as a disinfectant. Therefore it makes no sense to measure it with the chlorine sensor. Yet both hypochlorous acid and hypochlorite are considered to be "free chlorine" and, as such, are also measured by the DPD 1 measuring method, generally used as a comparison measurement.

A corresponding example:

At pH 8 (see Fig. pk_6_003), only some 20% is in the effective HOCl form, while 80% is in the nearly ineffective form OCl⁻. However, it is possible to set this up using a sensitivity (slope) comparison to obtain a value corresponding to the DPD comparison measurement on the measuring device display.

The pH value needs to be kept constant for a useful measurement. If not, a new slope calibration must be carried out. The maximum permissible pH value is pH 8.0 for the sensors for inorganic chlorine and pH 9.5 for organic chlorine.



1.1 Sensor Technology DULCOTEST® Measuring Principles

The influence of temperature on chlorine measurement is not insignificant. Therefore automatic temperature compensation occurs in DULCOTEST® chlorine sensors

While there are no problems with chlorine measurements involving inorganic chlorine (chlorine gas Cl_2 , sodium-calcium hypochlorite NaOCl or calcium hypochlorite $\text{Ca}(\text{OCl})_2$) provided the pH value remains constant, if organic chlorine additives are used (isocyanuric acid) then difficulties may occur which can be easily overcome using the organic chlorine cell (CGE).

If organic chlorine stabilisers are added, then not only does hypochlorous acid form, but also chlorine bound to isocyanuric acid. Both species are detected by the organic chlorine sensor (CGE).

If a measurement is made using the DPD 1 method, organic chlorine is also measured, in the same way as the practically ineffective hypochlorite (at high pH values). In this case, the DPD measurement can falsify hygienic safety, which is not in fact the case.

Typical applications for DULCOTEST® chlorine sensors include swimming pool water (also sea water), potable water and process water

The chlorine measurement can be disrupted by bromine, iodine, ozone and chlorine dioxide. Not however by dissolved oxygen. The presence of surfactants will block the working of the diaphragms of the sensor for free chlorine, type CLE. The sensor cannot then be used, by contrast, however, the CTE type combined chlorine sensor can be used in applications such as this.

A cell that functions according to the same principle as for the inorganic chlorine measurement is used to measure chlorine dioxide. The chlorine dioxide measurement is independent of the pH value. Its temperature dependency is compensated. Dissolved oxygen and chlorite do not interfere with the measurement results. The presence of surfactants causes problems with CDE type sensors. By contrast, the CDP type can also be used in media containing surfactants.

In addition amperometric sensors can also be used for the measurement of bromine and ozone dissolved in water.

1.1.4 Advantages of DULCOTEST® Amperometric Sensors at a Glance

Simple to use

- No zero point calibration necessary
- Sample liquid need not be de-chlorinated with active carbon filter
- Installation and calibration is very quick

Reliable measurement in real-time

- No cross-sensitivity because of turbidity and colouration
- The DULCOTEST® chlorine measurement can also be used in sea water and brine baths
- The measured value is largely unaffected by the flow rate
- Online measurement

Minimum maintenance

- Maintenance is limited to the 6-12 month replacement of the membrane cap and electrolyte
- Long-term operating costs are therefore low



1.1 Sensor Technology DULCOTEST® Measuring Principles

1.1.5 Conductometry – The Measurement of Electrolytic Conductivity

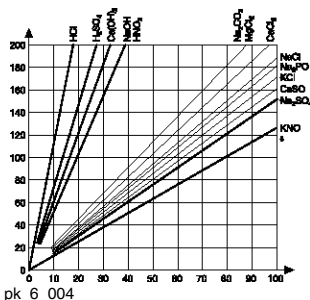

pk_6_004
Dependence of electrolytic conductivity on the concentration of dissolved acids, alkalis and salt solutions

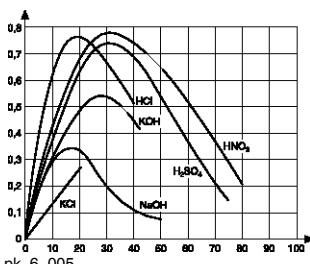

pk_6_005
Dependence of specific conductivity on the concentration in percentage weight of concentrated acids, alkalis and salt solutions

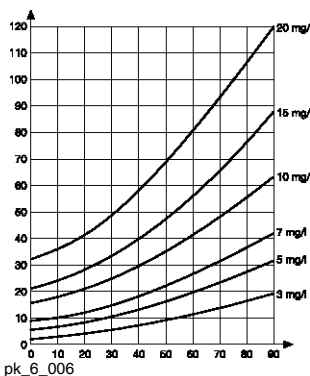

pk_6_006
Conductivity of aqueous solutions of NaCl depending on the temperature of different concentrations

In contrast to metallic conductivity where the electric charge is carried by electrons, in electrolytic conductivity, ions are responsible for carrying the charge, that is positively or negatively charged atoms or groups of atoms which are primarily created by dissolving in or dissociation in aqueous solutions. Conductivity sensors are differentiated according to the following criteria:

- **The cell constant as a distinguishing feature**
An arrangement in which the conductivity of an electrolyte would be measured in a tube of length $l = 1 \text{ cm}$ and cross section $q = 1 \text{ cm}^2$ has a cell constant of $k = 1 \text{ cm}^{-1}$. If the length $l = 10 \text{ cm}$ (or if the cross section $q = 0.1 \text{ cm}^2$), then the cell constant would be $k = 10 \text{ cm}^{-1}$. By contrast, if the cross section was increased to $q = 10 \text{ cm}^2$ (or l reduced to 0.1 cm), then a cell constant of $k = 0.1 \text{ cm}^{-1}$ is obtained. It can easily be seen that a conductivity sensor with a smaller cell constant is used for measurements of lower conductivity while a cell with a larger cell constant is used for higher conductivities. This is done to increase the measurement sensitivity at lower conductivities (e.g. $k = 0.1 \text{ cm}^{-1}$) – or to reduce it at higher conductivities (e.g. $k = 10 \text{ cm}^{-1}$).
- **Sensor materials**
The selection of the correct cell constant is just as important as selection of a suitable electrode material. Stainless steel has shown its suitability in the lower range, up to approximately $500 \mu\text{S/cm}$. By contrast in the upper range, where, because of the occurrence of polarisation effects, stainless steel is less suitable, special graphite is primarily used. As errors due to polarisation effects have to be avoided during electrolytic conductivity measurements, measurements can only be carried out using AC voltage. At low conductivities, frequencies of about 50 Hz are favoured and in the higher range up to approximately 5 kHz . Both at very low and also very high conductivities, long measuring lines can result in incorrect results, in the lower range caused by line capacities and in the upper range by line resistance. Therefore the distance between the sensor and measurement amplifier should be kept as short as possible.

Every conductivity measurement is temperature-dependent

Different dissolved substances mostly have different temperature coefficients α (alpha), leading to a particular temperature curve that can change depending on the concentration and temperature. (Fig. pk_6_006)

As, in general, conductivity measurements are used because we want to draw conclusions about substance concentrations, temperature compensation is used for exact measurements, even with a measured value compensated to an international standard reference temperature of $25 \text{ }^\circ\text{C}$. Suitable transducers for temperature compensation are NTC or Pt 100 temperature sensors with the Pt 100 being significantly superior because of its linearity and hence accuracy.

Inductive conductivity measurement

While errors can occur due to polarisation effects and deposits on the electrode surfaces, with open conductivity measurements, errors can be avoided using inductive conductivity measurement where no electrodes are used. Regular cleaning is therefore not necessary and measuring reliability is significantly higher.



1.2 pH, ORP, Fluoride and Temperature Sensors DULCOTEST®

The following generally applicable points should be noted for optimum functioning of pH and ORP sensors:

- The sensors should never dry out
- The insertion angle must be > 15 ° from the horizontal (except with PHEK-L)
- Maximum flow < 0.8 m/s
- Use of suitable measuring lines
- Measuring lines should be as short as possible
- Use of suitable measuring devices/transducers (high resistance input)
- Calibration using quality buffer solutions
- Selection of electrode type according to the application
- The storage duration should be as short as possible

Signal leads for pH/ORP measurement see page → 1-119, pH quality buffer solutions see page → 1-122

pH sensor selection guide

Medium	Temperature / pressure	Sensor type	Typical application
clear, pH 3 – 14	max. 100 °C / 3 bar	PHEP-H	Chemical processes
	max. 25 °C / 6 bar		
Clear, pH 2 – 12	max. 80 °C / no overpressure	PHEN	Chemically contaminated water, low-conductivity water ≥ 50 µS/cm
	max. 60 °C / 3 bar	PHES	Swimming pool water, potable water, glass stem
		PHEK	Swimming pool, aquarium, plastic shaft
	max. 80 °C / 6 bar	PHEP/PHEPT	Process water
	max. 80 °C / 8 bar	PHED	Chemically contaminated water, e.g. Cr ⁶⁺ , CN ⁻
Solid residues, turbidity	max. 80 °C / 6 bar	PHER/PHEI	Cooling water, waste water
Solid matter, non-translucent	max. 100 °C / 16 bar	PHEX	Suspensions, sludge, emulsions
Clear to turbid, containing fluoride, pH 0 - 7	max. 50 °C / 7 bar	PHEF	Exhaust air scrubber, semiconductor industry, electroplating

Note: All DULCOTEST® pH and ORP sensors are made using lead-free glass (RoHS-compliant)



1.2 pH, ORP, Fluoride and Temperature Sensors DULCOTEST®

DULCOTEST® ORP sensor selection guide

Medium	Temperature / pressure	Sensor type	Typical application
Clear, pH 2 – 12	max. 80 °C / no overpressure	RHEN	Chemically contaminated water, low-conductivity water $\geq 50 \mu\text{S/cm}$
	max. 60 °C / 3 bar	RHES	Swimming pool water, potable water, glass stem
		RHEK	Swimming pool, aquarium, plastic shaft
	max. 80 °C / 6 bar	RHEP-Pt	Process water
		RHEP-Au	Chemically contaminated water, e.g. CN^- , ozone treatment
Solid residues, turbidity	max. 80 °C / 6 bar	RHER	Cooling water, waste water
Solid matter, non-translucent	max. 100 °C / 16 bar	RHEX	Suspensions, sludge, emulsions

Note: All DULCOTEST® pH and ORP sensors are made using lead-free glass (RoHS-compliant)



1.2 pH, ORP, Fluoride and Temperature Sensors DULCOTEST®

1.2.1 pH Sensors With SN6 or Vario Pin Plug-In Head

pH sensors with plug-in heads are connected to a shielded coaxial cable with the appropriate socket. The rotatable sensor head sleeve prevents the cable from twisting when inserting and dismantling the sensor (e.g. when calibrating). The cable can therefore remain connected. This avoids the penetration of troublesome water onto the plug-in contacts.

Series	
PHE	pH sensor
Properties	
X	With solid electrolyte and circular gap diaphragm
K	With insensitive plastics shaft
N	KCl refillable sensor
E	Plug-in sensor
R	With PTFE circular diaphragm
P	Pressure-tight up to 6 bar
D	2 ceramics diaphragms (double junction)
S	Swimming pool sensor
F	Resistant to hydrofluoric acid
I	Robust sensor, plastic housing with NPT thread, double junction, Teflon diaphragm
	Without specification: standard gel sensor
Special equipment	
T	With integral temperature gauge
H	Temperature up to 100 °C, alkali-resistant
L	Vertical to horizontal installation
pH measuring range	
012	pH measuring range: 0 – 12
112	pH measuring range: 1 - 12
314	pH measuring range: 3 – 14
Electrical connection at the sensor	
S	Plug for coax connector SN6
V	Vario Pin plug
Internal thread	
E	Internal thread PG 13.5 for installation
L	None, laboratory sensor refillable with KCl
Diaphragm	
3D	3 ceramic diaphragms



1.2 pH, ORP, Fluoride and Temperature Sensors DULCOTEST®



pH Sensor PHES 112 SE

pH sensor optimised for use in potable water treatment, swimming pools/hot tubs at up to 60 °C/3 bar

Your benefits

- Electrochemical combination electrode: pH and reference electrode integrated
- Diaphragm and reference system optimised for use in swimming pools and for potable water
- Ceramic diaphragm with special material, optimised size and optimised pore diameter
- Long service life due to reduced diffusion ("bleeding") of the electrolyte
- Long service life due to the material, which is inert to aggressive disinfectants
- Stable reference system
- Twist protection for the sensor cable connected. This means that the cables can remain connected during installation and dismantling of the sensor, avoiding troublesome moisture on the connector contacts
- Lead-free glass for advanced and environmentally-friendly production, use and disposal (RoHS-compliant)

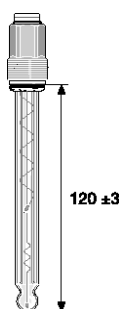

pk_6_016

pH range	1 ... 12
Temperature	0 ... 60 °C
Max. pressure	3.0 bar
Min. conductivity	150 µS/cm
Electrolyte	Gel containing potassium chloride
Diaphragm	Ceramic
Sensor shaft	Glass
Shaft diameter	12 mm
Fitting length	120 ±3 mm
Fitting position	Vertical up to +25°
Thread	PG 13.5
Electrical connection	SN6 plug-in head, rotatable with a ProMinent cable
Enclosure rating	IP 65
Installation	Bypass: open outlet or return of the sample water into the process line, inline: direct installation into the pipework; fixed or replaceable (replaceable fitting), tank, channel: Immersion in the immersion tube
Measuring and control equipment	All DULCOMETER® controllers and solenoid-driven metering pumps types D_4a and delta®
Typical applications	Swimming pools, whirlpools, potable water
Resistance to	Disinfectant
Measuring principle, technology	Direct potentiometric measurement, 2 electrodes, gel electrolyte, ceramic diaphragm, separate temperature measurement for temperature compensation needed

	Fitting length	Order no.
PHES-112-SE SLg100	100 ±3 mm	1051745
PHES 112 SE	120 ±3 mm	150702
PHES-112-SE SLg225	225 ±3 mm	150092



1.2 pH, ORP, Fluoride and Temperature Sensors DULCOTEST®



pH Sensor PHES 112 SE 3D

pH sensor optimised for use in potable water treatment, swimming pools/hot tubs and at low electrolytic conductivities of up to 60 °C/3 bar

Your benefits

- Electrochemical combination electrode: pH and reference electrode integrated
- Diaphragm and reference system optimised for use in swimming pools
- Ceramic diaphragm with special material, optimised size and optimised pore diameter
- Three ceramic diaphragms optimised for low electrolytic conductivities
- Long service life due to reduced diffusion ("bleeding") of the electrolyte
- Long service life due to the material, which is inert to aggressive disinfectants
- Stable reference system
- Twist protection for the sensor cable connected. This means that the cables can remain connected during installation and dismantling of the sensor, avoiding troublesome moisture on the connector contacts
- Lead-free glass for advanced and environmentally-friendly production, use and disposal (RoHS-compliant)

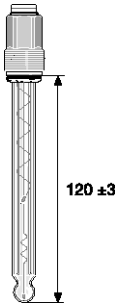

pk_6_016

pH range	1 ... 12
Temperature	0 ... 60 °C
Max. pressure	3.0 bar
Min. conductivity	50 µS/cm
Electrolyte	Gel containing potassium chloride
Diaphragm	3 Ceramic diaphragms
Sensor shaft	Glass
Shaft diameter	12 mm
Fitting length	120 ±3 mm
Fitting position	Vertical up to +25°
Thread	PG 13.5
Electrical connection	SN6 plug-in head, rotatable with a ProMinent cable
Enclosure rating	IP 65
Installation	Bypass: open outlet or return of the sample water into the process line, inline: direct installation into the pipework; fixed or replaceable (replaceable fitting), tank, channel: Immersion in the immersion tube
Measuring and control equipment	All DULCOMETER® controllers and solenoid-driven metering pumps types D_4a and delta®
Typical applications	Low conductivity water
Resistance to	Disinfectant
Measuring principle, technology	Bypass: open outlet or return of the sample water into the process line, inline: direct installation into the pipework; fixed or replaceable (replaceable fitting), tank, channel: Immersion in the immersion tube

	Order no.
PHES 112 SE 3D	1045759



1.2 pH, ORP, Fluoride and Temperature Sensors DULCOTEST®

pH Sensor PHEP 112 SE

pH sensor optimised for use with clear process water and conditions of up to 80 °C/6 bar



Your benefits

- Electrochemical combination electrode: pH and reference electrode integrated
- Diaphragm and reference system optimised for exacting process requirements
- Ceramic diaphragm with special material, optimised size and optimised pore diameter
- Long service life due to reduced diffusion ("bleeding") of the electrolyte
- Long service life due to the material, which is inert to aggressive disinfectants
- Stable reference system for high pressure/temperature requirements
- Twist protection for the sensor cable connected. This means that the cables can remain connected during installation and dismantling of the sensor, avoiding troublesome moisture on the connector contacts
- Lead-free glass for advanced and environmentally-friendly production, use and disposal (RoHS-compliant)

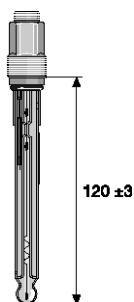

pk_6_019

pH range	1 ... 12
Temperature	0 ... 80 °C
Max. pressure	6.0 bar
Min. conductivity	150 µS/cm
Electrolyte	Gel containing potassium chloride
Diaphragm	Ceramic
Sensor shaft	Glass
Shaft diameter	15 mm
Fitting length	120 ±3 mm
Fitting position	Vertical up to +25°
Thread	PG 13.5
Electrical connection	SN6 plug-in head, rotatable with a ProMinent cable
Enclosure rating	IP 65
Installation	Bypass: open outlet or return of the sample water into the process line, inline: direct installation into the pipework; fixed or replaceable (replaceable fitting), tank, channel: Immersion in the immersion tube
Measuring and control equipment	All DULCOMETER® controllers and solenoid-driven metering pumps types D_4a and delta®
Typical applications	Swimming pools during pressurisation for higher temperatures and pressures, potable and industrial water, electroplating, chemical industries
Resistance to	Disinfectant
Measuring principle, technology	Direct potentiometric measurement, 2 electrodes, gel electrolyte, ceramic diaphragm, separate temperature measurement for temperature compensation needed

	Order no.
PHEP 112 SE	150041



1.2 pH, ORP, Fluoride and Temperature Sensors DULCOTEST®



pH Sensor PHEP-H 314 SE

pH sensor optimised for use with clear process water, specifically for alkaline process solutions at high temperatures of up to 100 °C

Your benefits

- Electrochemical combination electrode: pH and reference electrode integrated
- Diaphragm and reference system optimised for exacting process requirements
- Optimised pH-sensitive glass for high alkali content and high temperatures
- Long service life / excellent precision: Measurement at a high pH value of up to 14
- Long service life: at high temperatures of up to 100 °C
- Stable reference system for high pressure / temperature requirements
- Twist protection for the sensor cable connected. This means that the cables can remain connected during installation and dismantling of the sensor, avoiding troublesome moisture on the connector contacts
- Lead-free glass for advanced and environmentally-friendly production, use and disposal (RoHS-compliant)

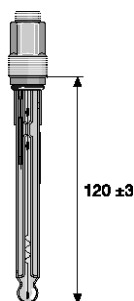

pk_6_019

pH range	3 ... 14 (Note: use below pH 3 shortens the service life)
Temperature	0 ... 100 °C
Max. pressure	6.0 bar up to 25 °C, 3.0 bar up to 100 °C
Min. conductivity	150 µS/cm
Electrolyte	Gel containing potassium chloride
Diaphragm	Ceramic
Sensor shaft	Glass
Shaft diameter	15 mm
Fitting length	120 ±3 mm
Fitting position	Vertical up to +25°
Thread	PG 13.5
Electrical connection	SN6 plug-in head, rotatable with a ProMinent cable
Enclosure rating	IP 65
Installation	Bypass: open outlet or return of the sample water into the process line, inline: direct installation into the pipework; fixed or replaceable (replaceable fitting), tank, channel: Immersion in the immersion tube
Measuring and control equipment	All DULCOMETER® controllers and solenoid-driven metering pumps types D_4a and delta®
Typical applications	Monitoring or control of chemical processes with neutral to highly-alkaline media and temperatures up to 100 °C
Resistance to	Disinfectant, high alkalinity
Measuring principle, technology	Direct potentiometric measurement, 2 electrodes, highly alkaline tempered glass, ceramic diaphragm, gel electrolyte, separate temperature measurement for temperature compensation needed

	Order no.
PHEP-H 314 SE	1024882



1.2 pH, ORP, Fluoride and Temperature Sensors DULCOTEST®



pH Sensor PHEI 112 SE

Reliable online measurement of pH values in industrial waste water/water – with DULCOTEST® sensors.

Your benefits

- Solid high-grade plastic housing with integrated process connection for direct installation in the process with 1/2" and 3/4" NPT thread
- Large dirt-repellent Teflon diaphragm protects against unwanted blocking of the reference
- Double junction reference system for stability with chemically polluted water
- Large electrolyte reservoir for long service lives

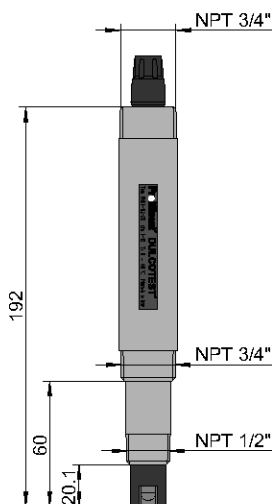

P_DT_0076_SW1

pH range	1 ... 12
Temperature	0 ... 80 °C
Max. pressure	6.0 bar
Min. conductivity	50 µS/cm
Electrolyte	gel containing potassium chloride with a large KCl reservoir of gel
Diaphragm	PTFE ring diaphragm
Sensor shaft	Plastic
Sensor shaft Ø	17 ±0.2 mm (below the 1/2" NPT thread), 22 ±0.2 mm (below the 3/4" thread)
Fitting length	20 ±0.2 mm (from the lower end of the 1/2" thread), 60 ±0.2 mm (from the lower end of the 3/4" thread)
Fitting position	Vertical up to +25°
Thread	1/2" and 3/4" NPT thread
Electrical connection	SN6 plug-in head, rotatable with a ProMinent cable
Enclosure rating	IP 65
Installation	Bypass: open outlet or return of the sample water into the process line, inline: direct installation into the pipework; fixed or replaceable (replaceable fitting), tank, channel: Immersion in the immersion tube
Measuring and control equipment	All DULCOMETER® controllers and solenoid-driven metering pumps types D_4a and delta®
Typical applications	Municipal and industrial waste water Cooling water, Process water, Water in the chemical industry and paper making, generally for water with a solid matter fraction
Resistance to	Disinfectant, solids content (turbid water), water-soluble chemicals
Measuring principle, technology	direct potentiometric measurement, 2 probes, double junction, gel electrolyte, large Teflon diaphragm, separate temperature measurement for temperature compensation needed

	Order no.
PHEI 112 SE	1076610

Accessories

	Order no.
Adapter for DGMA; M34x3/4" NPT PVDF natural	1077156



1.2 pH, ORP, Fluoride and Temperature Sensors DULCOTEST®



pH Sensor PHER 112 SE

pH sensor optimised for use in contaminated water containing solids and for low conductivity of $> 50 \mu\text{S}/\text{cm}$ at up to $80^\circ\text{C}/6 \text{ bar}$

Your benefits

- Electrochemical combination electrode: pH and reference electrode integrated
- The large dirt-repellent Teflon® diaphragm prevents the reference system from becoming blocked up
- Long service life when solids are present
- High-viscosity electrolyte combined with a salt reservoir prevents the electrolyte from "bleeding"
- Long service life without drifts when there is clear water with low conductivity
- Twist protection for the sensor cable connected. This means that the cables can remain connected during installation and dismantling of the sensor, avoiding troublesome moisture on the connector contacts
- Lead-free glass for advanced and environmentally-friendly production, use and disposal (RoHS-compliant)

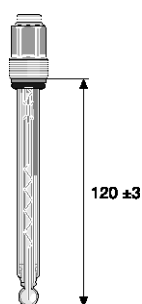

pk_6_018

pH range	1 ... 12
Temperature	0 ... 80 °C
Max. pressure	6.0 bar
Min. conductivity	50 $\mu\text{S}/\text{cm}$
Electrolyte	With KCl supply (salt rings in the reference electrolyte)
Diaphragm	PTFE ring diaphragm
Sensor shaft	Glass
Shaft diameter	12 mm
Fitting length	120 ± 3 mm
Fitting position	Vertical up to +25°
Thread	PG 13.5
Electrical connection	SN6 plug-in head, rotatable with a ProMinent cable
Enclosure rating	IP 65
Installation	Bypass: open outlet or return of the sample water into the process line, inline: direct installation into the pipework; fixed or replaceable (replaceable fitting), tank, channel: Immersion in the immersion tube
Measuring and control equipment	All DULCOMETER® controllers and solenoid-driven metering pumps types D_4a and delta®
Typical applications	Municipal and industrial waste water, cooling water, industrial water, water in chemicals industry and paper production, generally for water with a solid matter fraction, water with low conductivity, e.g. from reverse osmosis.
Resistance to	Disinfectant, solids content (turbid types of water)
Measuring principle, technology	Direct potentiometric measurement, 2 electrodes, Teflon ring diaphragm, polymer electrolyte, separate temperature measurement for temperature compensation needed

Order no.

PHER 112 SE

1001586

1.2 pH, ORP, Fluoride and Temperature Sensors DULCOTEST®

pH Sensor PHEX 112 SE

pH sensor optimised for use with contaminated water with a high solids content at 6 bar/100 °C or 16 bar/25 °C



Your benefits

- Electrochemical combination electrode: pH and reference electrode integrated
- Diaphragm and reference system optimised for extremely high solids content
- The solid electrolyte makes the diaphragm redundant and prevents the reference system from becoming blocked up
- Long service life when sludge is present due to lack of a diaphragm
- Long service life as the solid electrolyte prevents the electrolyte from "bleeding"
- Stable reference system
- Twist protection for the sensor cable connected. This means that the cables can remain connected during installation and dismantling of the sensor, avoiding troublesome moisture on the connector contacts
- Lead-free glass for advanced and environmentally-friendly production, use and disposal (RoHS-compliant)

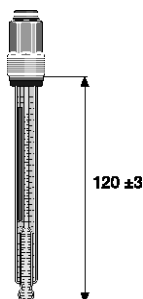

pk_6_017

pH range	1 ... 12
Temperature	0 ... 100 °C
Max. pressure	16.0 bar up to 25 °C, 6.0 bar up to 100 °C
Min. conductivity	500 µS/cm
Electrolyte	Polymer containing potassium chloride (solid)
Diaphragm	Circular gap diaphragm (solid electrolyte)
Sensor shaft	Glass
Shaft diameter	12 mm
Fitting length	120 ±3 mm
Fitting position	Vertical up to +25°
Thread	PG 13.5
Electrical connection	SN6 plug-in head, rotatable with a ProMinent cable
Enclosure rating	IP 65
Installation	Bypass: open outlet or return of the sample water into the process line, inline: direct installation into the pipework; fixed or replaceable (replaceable fitting), tank, channel: Immersion in the immersion tube
Measuring and control equipment	All DULCOMETER® controllers and solenoid-driven metering pumps types D_4a and delta®
Typical applications	Waste water, industrial water, process chemistry, emulsions, suspensions, protein-containing media, in general for water with a high solid fraction, not suitable for use in clear water. not suitable for media with oxidation agents
Resistance to	Solids content (turbid types of water), sludge, emulsions
Measuring principle, technology	Direct potentiometric measurement, 2 electrodes, no diaphragm, polymer electrolyte, separate temperature measurement for temperature compensation needed

	Fitting length	Order no.
PHEX 112 SE	120 ±3 mm	305096
PHEX 112 SE	225 ±3 mm	150061

ex HD works



1.2 pH, ORP, Fluoride and Temperature Sensors DULCOTEST®



pH Sensor PHED 112 SE

pH sensor optimised for use with chemically contaminated but clear water at up to 80 °C/8 bar

Your benefits

- Electrochemical combination electrode: pH and reference electrode integrated
- Diaphragm and reference system optimised for use in chemically contaminated but clear water
- Double junction: two coupled ceramic diaphragms protect the reference system
- Long service life when chemical pollutants are present
- Special construction permits a maximum pressure of 8 bar
- Twist protection for the sensor cable connected. This means that the cables can remain connected during installation and dismantling of the sensor, avoiding troublesome moisture on the connector contacts
- Lead-free glass for advanced and environmentally-friendly production, use and disposal (RoHS-compliant)

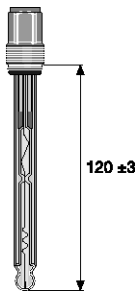

pk_6_022

pH range	1 ... 12
Temperature	0 ... 80 °C
Max. pressure	8.0 bar
Min. conductivity	150 µS/cm
Electrolyte	Gel containing potassium chloride
Diaphragm	Double junction
Sensor shaft	Glass
Shaft diameter	12 mm
Fitting length	120 ± 3 mm
Fitting position	Vertical up to +25°
Thread	PG 13.5
Electrical connection	SN6 plug-in head, rotatable with a ProMinent cable
Enclosure rating	IP 65
Installation	Bypass: open outlet or return of the sample water into the process line, inline: direct installation into the pipework; fixed or replaceable (replaceable fitting), tank, channel: Immersion in the immersion tube
Measuring and control equipment	All DULCOMETER® controllers and solenoid-driven metering pumps types D_4a and delta®
Typical applications	Chemically loaded waste water, industrial water, cooling water
Resistance to	Disinfectants, water-soluble chemicals
Measuring principle, technology	Direct potentiometric measurement, 2 electrodes, double junction, gel electrolyte, separate temperature measurement for temperature compensation needed

Order no.

PHED 112 SE

741036



1.2 pH, ORP, Fluoride and Temperature Sensors

DULCOTEST®

pH Sensor PHEF 012 SE



pH sensor optimised for use with acidic water containing fluoride and abrasive water containing solids at up to 50 °C/7 bar

Your benefits

- Electrochemical combination electrode: pH and reference electrode integrated
- Optimised pH glass for use in the presence of glass-corroding hydrofluoric acid (HF). HF is formed primarily in the presence of fluoride (F⁻) at a pH of < 4. Glass corrosion is promoted by a constant concentration of fluoride, a falling pH value and a rising temperature. The glass composition and structure of the PHEF type reduce the release of SiF₄. Extended service life in the presence of fluoride (F⁻) at a pH of < 7
- Twist protection for the sensor cable connected. This means that the cables can remain connected during installation and dismantling of the sensor, avoiding troublesome moisture on the connector contacts
- The flat shape of the glass diaphragm and large ring diaphragm facilitate use in contaminated water, which also contains abrasive solids

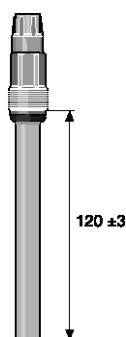

pk_6_007

HF

pH range	0 ... 12
Temperature	0 ... 50 °C
Max. pressure	7.0 bar
Min. conductivity	150 µS/cm
Electrolyte	Gel containing potassium chloride
Diaphragm	HDPE ring diaphragm, flat (Double Junction)
Sensor shaft	Epoxy
Shaft diameter	12 mm
Fitting length	120 ± 3 mm
Fitting position	Vertical up to +25°
Thread	PG 13.5
Electrical connection	SN6 plug-in head, rotatable with a ProMinent cable
Enclosure rating	IP 65
Installation	Bypass: open outlet or return of the sample water into the process line, inline: direct installation into the pipework; fixed or replaceable (replaceable fitting), tank, channel: Immersion in the immersion tube
Measuring and control equipment	All DULCOMETER® controllers and solenoid-driven metering pumps types D_4a and delta®
Typical applications	A significantly longer service life can be achieved compared with standard pH sensors in media containing hydrofluoric acid, e.g. waste water from the semiconductor industry or electroplating applications and air scrubbers
Resistance to	Disinfectant, solids content (turbid types of water), hydrofluoric acid (HF), abrasive particles
Measuring principle, technology	Direct potentiometric measurement, 2 electrodes, PE ring diaphragm, HF-compatible flat glass diaphragm, gel electrolyte, separate temperature measurement for temperature compensation needed

	Order no.
PHEF 012 SE	1010511



1.2 pH, ORP, Fluoride and Temperature Sensors DULCOTEST®



pH Sensor PHEN 112 SE

Refillable pH sensor optimised for use with chemically contaminated water at up to 80 °C/without excess pressure

Your benefits

- Electrochemical combination electrode: pH and reference electrode integrated
- Renewable liquid electrolyte by continuous replenishment from an electrolyte bottle installed above the electrode
- 1 ceramic diaphragm made of special material and with an optimised size / with optimised pore diameter
- Twist protection for the sensor cable connected. This means that the cables can remain connected during installation and dismantling of the sensor, avoiding troublesome moisture on the connector contacts
- Long service life in the presence of chemicals dissolved in the water, which could contaminate the reference system
- Lead-free glass for advanced and environmentally-friendly production, use and disposal (RoHS-compliant)

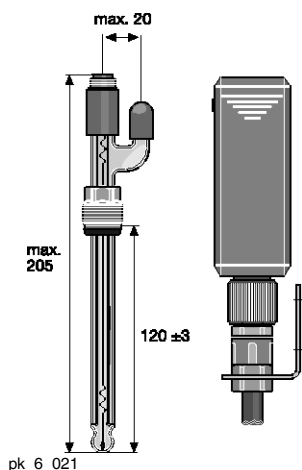

pH range	1 ... 12
Temperature	0 ... 80 °C
Max. pressure	Atmospheric pressure
Min. conductivity	150 µS/cm
Electrolyte	KCL electrolyte, refillable
Diaphragm	Ceramic
Sensor shaft	Glass
Shaft diameter	12 mm
Fitting length	120 ±3 mm
Fitting position	Vertical up to +25°
Thread	PG 13.5
Electrical connection	SN6 plug-in head, rotatable with a ProMinent cable
Enclosure rating	IP 65
Installation	Bypass: open outlet or return of the sample water into the process line, inline: direct installation into the pipework; fixed or replaceable (replaceable fitting), tank, channel: Immersion in the immersion tube
Measuring and control equipment	All DULCOMETER® controllers and solenoid-driven metering pumps types D_4a and delta®
Typical applications	Waste water, cooling water, chemically contaminated water
Resistance to	Disinfectant, only for clear types of water
Measuring principle, technology	Direct potentiometric measurement, 2 electrodes, liquid electrolyte, 1 ceramic diaphragm, separate temperature measurement for temperature compensation needed

	Order no.
PHEN 112 SE	305090

Supplied without PE storage tank and tube

	Order no.
PE storage tank with connectors and tube	305058

We recommend installation approx. 0.5-1 m above the sample fluid level

	Capacity ml	Order no.
KCl solution, 3 molar	250	791440
KCl solution, 3 molar	1,000	791441



1.2 pH, ORP, Fluoride and Temperature Sensors DULCOTEST®



pH Sensor PHEN 112 SE 3D

Refillable pH sensor optimised for use in contaminated water containing solids and water with a low conductivity of > 50 µS/cm at up to 80 °C/without overpressure

Your benefits

- Electrochemical combination electrode: pH and reference electrode integrated
- Renewable liquid electrolyte by continuous replenishment from an electrolyte bottle installed above the electrode
- 3 ceramic diaphragms made of special material, with optimised size and optimised pore diameter
- Twist protection for the sensor cable connected. This means that the cables can remain connected during installation and dismantling of the sensor, avoiding troublesome moisture on the connector contacts
- Long service life in water with low conductivity > 50 µS/cm and where solids are present
- Lead-free glass for advanced and environmentally-friendly production, use and disposal (RoHS-compliant)

pH range	1 ... 12
Temperature	0 ... 80 °C
Max. pressure	Atmospheric pressure
Min. conductivity	50 µS/cm
Electrolyte	3 molar potassium chloride solution, refillable
Diaphragm	3 ceramic diaphragms
Sensor shaft	Glass
Shaft diameter	12 mm
Fitting length	120 ±3 mm
Fitting position	Vertical up to +25°
Thread	PG 13.5
Electrical connection	SN6 plug-in head, rotatable with a ProMinent cable
Enclosure rating	IP 65
Installation	Bypass: open outlet or return of the sample water into the process line, inline: direct installation into the pipework; fixed or replaceable (replaceable fitting), tank, channel: Immersion in the immersion tube
Measuring and control equipment	All DULCOMETER® controllers and solenoid-driven metering pumps types D_4a and delta®
Typical applications	Waste water, water with low conductivity, e.g. from reverse osmosis.
Resistance to	Disinfectant, solids content (turbid types of water)
Measuring principle, technology	Direct potentiometric measurement, 2 electrodes, liquid electrolyte, 1 ceramic diaphragm, separate temperature measurement for temperature compensation needed

	Order no.
PHEN 112 SE 3D	150078



1.2 pH, ORP, Fluoride and Temperature Sensors DULCOTEST®



pH Sensor PHEN 012 SL

Refillable pH sensor for use with manual measuring instruments, optimised for clear and also chemically contaminated water at up to 80 °C/without overpressure

Your benefits

- Electrochemical combination electrode: pH and reference electrode integrated
- Renewable liquid electrolyte by continuous replenishment from an electrolyte bottle installed above the electrode
- 1 ceramic diaphragm made of special material and with an optimised size / with optimised pore diameter
- Long service life in the presence of dissolved chemicals, which could contaminate the reference system
- Lead-free glass for advanced and environmentally-friendly production, use and disposal (RoHS-compliant)

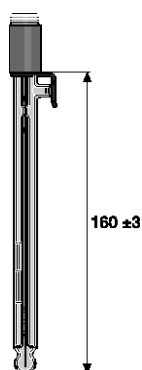

pk_6_020

pH range	0 ... 12
Temperature	0 ... 80 °C
Max. pressure	Atmospheric pressure
Min. conductivity	150 µS/cm
Electrolyte	KCl electrolyte, refillable
Diaphragm	Ceramic
Sensor shaft	Glass
Shaft diameter	12 mm
Fitting length	160 ±3 mm
Fitting position	Vertical up to +25°
Thread	None
Electrical connection	SN6 plug-in head
Enclosure rating	IP 65
Installation	Immersion by tripod or manually
Measuring and control equipment	All DULCOMETER® controllers and solenoid-driven metering pumps types D_4a and delta®
Typical applications	Manual measurements in laboratories
Resistance to	Disinfectants, water-soluble chemicals
Measuring principle, technology	Direct potentiometric measurement, 2 electrodes, liquid electrolyte, 1 ceramic diaphragm, separate temperature measurement for temperature compensation needed

PHEN 012 SL

Order no.

305078



1.2 pH, ORP, Fluoride and Temperature Sensors DULCOTEST®



pH Sensor PHEN 012 SL 3D

Refillable pH sensor for use with manual measuring instruments, optimised for contaminated water containing solids and with a low conductivity of > 50 µS/cm at up to 80 °C/without overpressure

Your benefits

- Electrochemical combination electrode: pH and reference electrode integrated
- Renewable liquid electrolyte by continuous replenishment from an electrolyte bottle installed above the electrode
- 3 ceramic diaphragms made of special material and with an optimised size / with optimised pore diameter
- Long service life in water with low conductivity > 50 µS/cm and where solids are present
- Lead-free glass for advanced and environmentally-friendly production, use and disposal (RoHS-compliant)

pH range	0 ... 12
Temperature	0 ... 80 °C
Max. pressure	Atmospheric pressure
Min. conductivity	50 µS/cm
Electrolyte	3 molar potassium chloride solution, refillable
Diaphragm	3 ceramic diaphragms
Sensor shaft	Glass
Shaft diameter	12 mm
Fitting length	160 ±3 mm
Fitting position	Vertical up to +25°
Thread	None
Electrical connection	SN6 plug-in head
Enclosure rating	IP 65
Installation	Immersion by tripod or manually
Measuring and control equipment	All DULCOMETER® controllers and solenoid-driven metering pumps types D_4a and delta®
Typical applications	Laboratories, water with low conductivity, e.g. from reverse osmosis. Waste water
Resistance to	Disinfectant, solids content (turbid types of water)
Measuring principle, technology	Direct potentiometric measurement, 2 electrodes, liquid electrolyte, 3 ceramic diaphragms, separate temperature measurement for temperature compensation needed

Order no.

PHEN 012 SL 3D

791508



1.2 pH, ORP, Fluoride and Temperature Sensors DULCOTEST®



pH Sensor PHEK 112 S

pH sensor for use with manual measuring instruments, with plastic shaft, optimised for use in potable water treatment, swimming pools/hot tubs at up to 80 °C/3 bar

Your benefits

- Electrochemical combination electrode: pH and reference electrode integrated
- Diaphragm and reference system optimised for use in swimming pools and for potable water
- Ceramic diaphragm with special material, optimised size and optimised pore diameter
- With plastic shaft to prevent glass breakage
- Mechanical protection of the glass diaphragm
- Long service life due to reduced diffusion ("bleeding") of the electrolyte
- Long service life due to the material, which is inert to aggressive disinfectants
- Stable reference system
- Lead-free glass for advanced and environmentally-friendly production, use and disposal (RoHS-compliant)

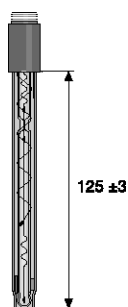

pk_6_023

pH range	1 ... 12
Temperature	0 ... 60 °C
Max. pressure	3.0 bar
Min. conductivity	150 µS/cm
Electrolyte	Gel containing potassium chloride
Diaphragm	Ceramic
Sensor shaft	Polycarbonate
Shaft diameter	12 mm
Fitting length	120 ± 3 mm
Fitting position	Vertical up to +25°
Thread	None
Electrical connection	SN6 plug-in head
Enclosure rating	IP 65
Installation	Immersion by tripod or manually
Measuring and control equipment	All DULCOMETER® controllers and solenoid-driven metering pumps types D_4a and delta®
Typical applications	Hand-held measurement in swimming pools, potable water
Resistance to	Disinfectant
Measuring principle, technology	Direct potentiometric measurement, 2 electrodes, gel electrolyte, ceramic diaphragm, separate temperature measurement for temperature compensation needed

Order no.

PHEK 112 S

305051



1.2 pH, ORP, Fluoride and Temperature Sensors DULCOTEST®

pH Sensor PHEK 112 SE



pH sensor with plastic shaft, optimised for use in potable water treatment, swimming pools/hot tubs at up to 60 °C/3 bar

Your benefits

- Electrochemical combination electrode: pH and reference electrode integrated
- Diaphragm and reference system optimised for use in swimming pools and for potable water
- Ceramic diaphragm with special material, optimised size and optimised pore diameter
- With plastic shaft to prevent glass breakage
- Mechanical protection of the glass diaphragm
- Long service life due to reduced diffusion ("bleeding") of the electrolyte
- Long service life due to the material, which is inert to aggressive disinfectants
- Stable reference system
- Twist protection for the sensor cable connected. This means that the cables can remain connected during installation and dismantling of the sensor, avoiding troublesome moisture on the connector contacts
- Lead-free glass for advanced and environmentally-friendly production, use and disposal (RoHS-compliant)

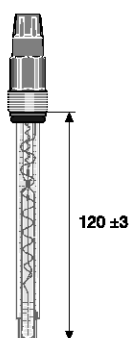

pk_6_090

pH range	1 ... 12
Temperature	0 ... 60 °C
Max. pressure	3.0 bar
Min. conductivity	150 µS/cm
Electrolyte	Gel containing potassium chloride
Diaphragm	Ceramic
Sensor shaft	Polycarbonate
Shaft diameter	12 mm
Fitting length	120 ±3 mm
Fitting position	Vertical up to +25°
Thread	PG 13.5
Electrical connection	SN6 plug-in head, rotatable with a ProMinent cable
Enclosure rating	IP 65
Installation	Bypass: open outlet or return of the sample water into the process line, inline: direct installation into the pipework; fixed or replaceable (replaceable fitting), tank, channel: Immersion in the immersion tube
Measuring and control equipment	All DULCOMETER® controllers and solenoid-driven metering pumps types D_4a and delta®
Typical applications	Swimming pools, potable water, aquaria
Resistance to	Disinfectant
Measuring principle, technology	Direct potentiometric measurement, 2 electrodes, gel electrolyte, ceramic diaphragm, separate temperature measurement for temperature compensation needed

PHEK 112 SE	Order no. 1028457
--------------------	-----------------------------

ex HD works



1.2 pH, ORP, Fluoride and Temperature Sensors DULCOTEST®



pH Sensor PHEK-L 112 SE

pH sensor with plastic shaft, optimised for use in potable water treatment, swimming pools/hot tubs, horizontal installation possible, at up to 60 °C/3 bar

Your benefits

- Electrochemical combination electrode: pH and reference electrode integrated
- With plastic shaft to prevent glass breakage
- Horizontal (level) installation possible (90° angle) (usually limited to 0 - 75° angle)
- Diaphragm and reference system optimised for use in swimming pools and for potable water
- Ceramic diaphragm with special material and optimised size / optimised pore diameter
- Long service life due to reduced diffusion ("bleeding") of the electrolyte
- Twist protection for the sensor cable connected. This means that the cables can remain connected during installation and dismantling of the sensor, avoiding troublesome moisture on the connector contacts
- Long service life due to the material, which is inert to aggressive disinfectants
- Stable reference system

pH range	1 ... 12
Temperature	0 ... 60 °C
Max. pressure	3.0 bar
Min. conductivity	150 µS/cm
Electrolyte	Gel containing potassium chloride
Diaphragm	Ceramic
Sensor shaft	Polycarbonate
Shaft diameter	12 mm
Fitting length	120 ±3 mm
Fitting position	Vertically to horizontally
Thread	PG 13.5
Electrical connection	SN6 plug-in head, rotatable with a ProMinent cable
Enclosure rating	IP 65
Installation	Bypass: open outlet or return of the sample water into the process line, inline: direct installation into the pipework; fixed or replaceable (replaceable fitting), tank, channel: Immersion in the immersion tube
Measuring and control equipment	All DULCOMETER® controllers and solenoid-driven metering pumps types D_4a and delta®
Typical applications	Swimming pools, potable water, aquaria. Horizontal installation possible.
Resistance to	Disinfectant
Measuring principle, technology	Direct potentiometric measurement, 2 electrodes, gel electrolyte, ceramic diaphragm, separate temperature measurement for temperature compensation needed

	Order no.
PHEK-L 112 SE	1034918

1.2 pH, ORP, Fluoride and Temperature Sensors DULCOTEST®



pH Sensor PHEPT 112 VE

pH sensor with integral temperature measurement, optimised for use with clear process water and changing process temperature of up to 80 °C/6 bar

Your benefits

- Electrochemical combination electrode: pH and reference electrode integrated
- Diaphragm and reference system optimised for exacting process requirements
- Ceramic diaphragm with special material, optimised size and optimised pore diameter
- Long service life due to reduced diffusion ("bleeding") of the electrolyte
- Long service life due to the material, which is inert to aggressive chemicals
- Stable reference system for high pressure / temperature requirements
- Integrated Pt 100 temperature sensor for temperature compensation of the pH measurement in higher-order measuring instruments eliminates the need for an additional sensor housing and external temperature sensor
- Vario Pin plug-in head with IP 67 specification
- Twist protection for the sensor cable connected. This means that the cables can remain connected during installation and dismantling of the sensor, avoiding troublesome moisture on the connector contacts
- Lead-free glass for advanced and environmentally-friendly production, use and disposal (RoHS-compliant)

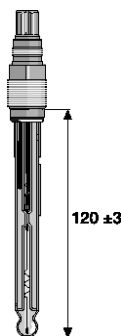

pk_6_068

pH range	1 ... 12
Temperature	0 ... 80 °C
Max. pressure	6.0 bar
Min. conductivity	150 µS/cm
Electrolyte	gel containing potassium chloride
Diaphragm	Ceramic
Sensor shaft	Glass
Shaft diameter	15 mm
Fitting length	120 ±3 mm
Fitting position	vertical up to +25°
Thread	PG 13.5
Electrical connection	Vario Pin plug-in head
Enclosure rating	IP 67
Installation	Bypass: open outlet or return of the sample water into the process line, inline: direct installation into the pipework; fixed or replaceable (replaceable fitting), tank, channel: Immersion in the immersion tube
Measuring and control equipment	all DULCOMETER® controllers (with the exception of DCCa pH)
Typical applications	Swimming pools during pressurisation for higher temperatures and pressures, potable and industrial water, electroplating, chemical industry, processes with a temperature change.
Resistance to	Disinfectant
Measuring principle, technology	Direct potentiometric measurement, 2 electrodes, gel electrolyte, ceramic diaphragm, integrated temperature measurement for temperature compensation

Order no.

PHEPT 112 VE	1004571
--------------	---------

Accessories: Measuring Line for Sensors with Vario Pin Plug-in Head

Ready-made 6-wire measuring line with Vario Pin plug for connection to sensor type PHEPT 112 VE.

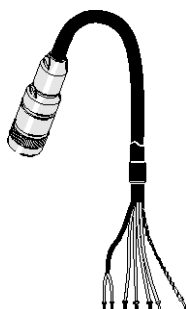

pk_6_069

	Length	Order no.
Vario Pin signal lead VP 6-ST/ 2 m	2 m	1004694
Vario Pin signal lead VP 6-ST/ 5 m	5 m	1004695
Vario Pin signal lead VP 6-ST/10 m	10 m	1004696



1.2 pH, ORP, Fluoride and Temperature Sensors DULCOTEST®

1.2.2 pH Sensors with Fixed Cable

pH sensors with fixed cable contain a shielded coaxial cable, which is firmly connected to the sensor head by a rotating sleeve, thereby preventing the cable from twisting when inserting and dismantling the sensor.

Series	
PHE	pH sensor
Properties	
X	with solid electrolyte and annular gap diaphragms
K	with insensitive plastic shaft
N	KCl refillable sensor
R	with PTFE ring diaphragms
P	pressure-tight up to 6 bar
D	with double diaphragm (double junction)
S	Swimming pool sensor
Special equipment	
T	with integral temperature gauge
pH measuring range	
112	pH measuring range: 1...12
Electrical connection at the sensor	
F	Fixed cable sensor
Internal thread	
E	Internal thread
L	none, laboratory sensor refillable
Cable diameter	
3	cable diameter 3 mm
5	cable diameter 5 mm
Cable length	
01	cable length in metres
Electrical connection at device	
S	SN6
D	DIN
B	BNC
O	without connector
M	SN6 male

The technical data corresponds to pH sensors with SN6 plug-in head (see page → 1-28)

pH Sensor PHES 112 F



pH sensor for use with manual measuring instruments, optimised for use in potable water treatment, swimming pools/hot tubs at up to 60 °C/3 bar

Your benefits

- Electrochemical combination electrode: pH and reference electrode integrated
- Diaphragm and reference system optimised for use in swimming pools and for potable water
- Ceramic diaphragm with special material, optimised size and optimised pore diameter
- Long service life due to reduced diffusion ("bleeding") of the electrolyte
- Long service life due to the material, which is inert to aggressive disinfectants
- Stable reference system
- Lead-free glass for advanced and environmentally-friendly production, use and disposal (RoHS-compliant)

pH sensor, gel-filled, with fixed coaxial cable and device plug, without screw-in thread.

	Cable length	Device plug	Order no.
	m		
PHES 112 F 301 S	1	SN6	304976
PHES 112 F 301 B	1	BNC	304980
PHES 112 F 303 B	3	BNC	304981

Further types on request.

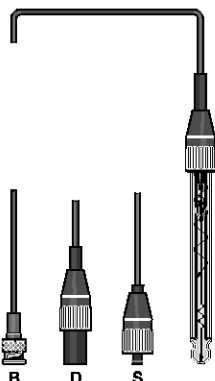

B D S

pk_6_024

1.2 pH, ORP, Fluoride and Temperature Sensors DULCOTEST®

pH Sensor PHES 112 FE



pH sensor optimised for use in potable water treatment, swimming pools/hot tubs at up to 60 °C/3 bar

Your benefits

- Electrochemical combination electrode: pH and reference electrode integrated
- Diaphragm and reference system optimised for use in swimming pools and for potable water
- Ceramic diaphragm with special material, optimised size and optimised pore diameter
- Long service life due to reduced diffusion ("bleeding") of the electrolyte
- Long service life due to the material, which is inert to aggressive disinfectants
- Stable reference system
- Rotating sensor head sleeve prevents the cable twisting when inserting and dismantling the sensor
- Lead-free glass for advanced and environmentally-friendly production, use and disposal (RoHS-compliant)

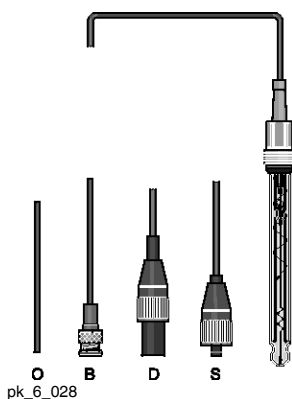

	Cable length m	Device plug	Order no.
PHES 112 FE 303 S	3	SN6	304984
PHES 112 FE 310 S	10	SN6	304985
PHES 112 FE 503 D	3	DIN	304986
PHES 112 FE 303 B	3	BNC	304988
PHES 112 FE 310 O	10	without	304990
PHES 112 FE 301 B	1	BNC	150079
PHES 112 FE 301 S	1	SN6	150926
PHES 112 FE 303 O	1	without	150101

Further types on request.

pH Sensor PHEK 112 F



pH sensor for use with manual measuring instruments, with plastic shaft, optimised for use in potable water treatment, swimming pools/hot tubs at up to 80 °C/3 bar

Your benefits

- Electrochemical combination electrode: pH and reference electrode integrated
- Diaphragm and reference system optimised for use in swimming pools and for potable water
- Ceramic diaphragm with special material, optimised size and optimised pore diameter
- With plastic shaft to prevent glass breakage
- Mechanical protection of the glass diaphragm
- Long service life due to reduced diffusion ("bleeding") of the electrolyte
- Long service life due to the material, which is inert to aggressive disinfectants
- Stable reference system
- Lead-free glass for advanced and environmentally-friendly production, use and disposal (RoHS-compliant)

pH sensor with polycarbonate plastic shaft, glass membrane protection, with fixed coaxial cable and device plug, without screw-in thread.

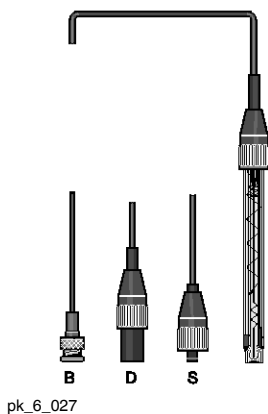

	Cable length m	Device plug	Order no.
PHEK 112 F 301 S	1	SN6	304994
PHEK 112 F 501 D	1	DIN	304995
PHEK 112 F 301 B	1	BNC	304996

Further types on request.



1.2 pH, ORP, Fluoride and Temperature Sensors DULCOTEST®

1



pH Sensor PHEK 112 FE

pH sensor with plastic shaft, optimised for use in potable water treatment, swimming pools/hot tubs at up to 60 °C/3 bar

Your benefits

- Electrochemical combination electrode: pH and reference electrode integrated
- Diaphragm and reference system optimised for use in swimming pools and for potable water
- Ceramic diaphragm with special material, optimised size and optimised pore diameter
- With plastic shaft to prevent glass breakage
- Mechanical protection of the glass diaphragm
- Long service life due to reduced diffusion ("bleeding") of the electrolyte
- Long service life due to the material, which is inert to aggressive disinfectants
- Stable reference system
- Rotating sensor head sleeve prevents the cable twisting when inserting and dismantling the sensor
- Lead-free glass for advanced and environmentally-friendly production, use and disposal (RoHS-compliant)

pH sensor with polycarbonate plastic shaft, glass membrane protection, with fixed coaxial cable and device plug, with screw-in thread.

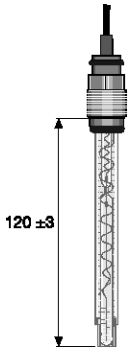

pk_6_090_1

	Cable length m	Device plug	Order no.
PHEK 112 FE 303 B	3	BNC	1028458

Other types on request.



pH Sensor PHEP 112 FE

pH sensor optimised for use with clear process water and conditions of up to 80 °C/6 bar

Your benefits

- Electrochemical combination electrode: pH and reference electrode integrated
- Diaphragm and reference system optimised for exacting process requirements
- Ceramic diaphragm with special material, optimised size and optimised pore diameter
- Long service life due to reduced diffusion ("bleeding") of the electrolyte
- Long service life due to the material, which is inert to aggressive disinfectants
- Stable reference system for high pressure/temperature requirements
- Rotating sensor head sleeve prevents the cable twisting when inserting and dismantling the sensor
- Lead-free glass for advanced and environmentally-friendly production, use and disposal (RoHS-compliant)

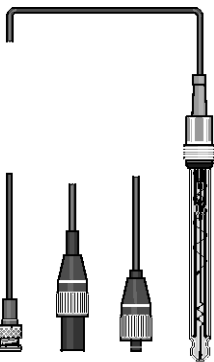

pk_6_028

	Cable length m	Device plug	Order no.
PHEP 112 FE 303 S	3	SN 6	150673
PHEP 112 FE 305 O	5	without	150689
PHEP 112 FE 510 O	10	without	150929

Further types on request.



1.2 pH, ORP, Fluoride and Temperature Sensors DULCOTEST®

pH Sensor PHER 112 FE



pH sensor optimised for use in contaminated water containing solids and for low conductivity of > 50 µS/cm at up to 80 °C/6 bar

Your benefits

- Electrochemical combination electrode: pH and reference electrode integrated
- The large dirt-repellent Teflon® diaphragm prevents the reference system from becoming blocked up
- Long service life when solids are present
- High-viscosity electrolyte combined with a salt reservoir prevents the electrolyte from "bleeding"
- Long service life without drifts when there is clear water with low conductivity
- Rotating sensor head sleeve prevents the cable twisting when inserting and dismantling the sensor
- Lead-free glass for advanced and environmentally-friendly production, use and disposal (RoHS-compliant)

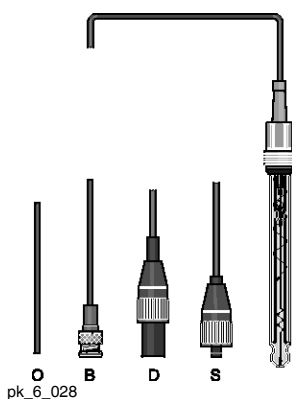

	Cable length m	Device plug	Order no.
PHER 112 FE 503 O	3	without	150878
PHER 112 FE 510 O	10	without	150874

Other types on request.

pH Sensor PHEX 112 FE



pH sensor optimised for use with contaminated water with a high solids content at 6 bar/100 °C or 16 bar/25 °C

Your benefits

- Electrochemical combination electrode: pH and reference electrode integrated
- Diaphragm and reference system optimised for extremely high solids content
- The solid electrolyte makes the diaphragm redundant and prevents the reference system from becoming blocked up
- Long service life when sludge is present due to lack of a diaphragm
- Long service life as the solid electrolyte prevents the electrolyte from "bleeding"
- Stable reference system
- Rotating sensor head sleeve prevents the cable twisting when inserting and dismantling the sensor
- Lead-free glass for advanced and environmentally-friendly production, use and disposal (RoHS-compliant)

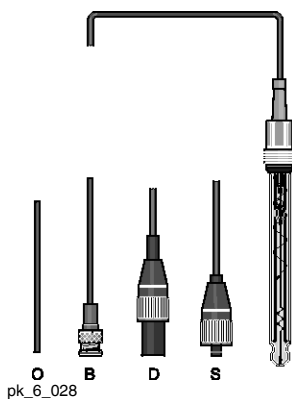

	Cable length m	Device plug	Order no.
PHEX 112 FE 510 S	10	SN 6	150025
PHEX 112 FE 510 O	10	without	150084
PHEX 112 FE 302 O	2	without	150086

Further types on request.



1.2 pH, ORP, Fluoride and Temperature Sensors DULCOTEST®

pH Sensor PHED 112 FE

pH sensor optimised for use with chemically contaminated but clear water at up to 80 °C/8 bar



Your benefits

- Electrochemical combination electrode: pH and reference electrode integrated
- Diaphragm and reference system optimised for use in chemically contaminated but clear water
- Double junction: two coupled ceramic diaphragms protect the reference system
- Long service life when chemical pollutants are present
- Special construction permits a maximum pressure of 8 bar
- Rotating sensor head sleeve prevents the cable twisting when inserting and dismantling the sensor
- Lead-free glass for advanced and environmentally-friendly production, use and disposal (RoHS-compliant)

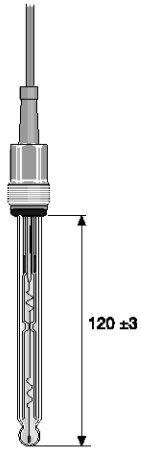

Cable length	Device plug	Order no.
m		

PHED 112 FE 303 B	3 BNC	741038
-------------------	-------	--------

Further types on request.



1.2 pH, ORP, Fluoride and Temperature Sensors

DULCOTEST®

1.2.3 ORP Sensors with SN6 Plug-in Head

ORP sensors with SN6 plug-in head are connected to a shielded coaxial cable with the appropriate socket. The rotating sensor head sleeve prevents the cable from twisting when inserting and dismantling the sensor. The cable can therefore remain connected. This avoids moisture from contacting the plug-in contacts.

Series	
RHE	ORP sensor
Properties	
X	with solid electrolyte and circular gap diaphragm
K	with insensitive plastic shaft
P	pressure tight up to 6 bar
R	with PTFE circular diaphragm
N	KCl refillable sensor
S	swimming pool sensor
Special equipment	
L	vertical to horizontal installation
Sensor material	
Pt	Platinum (pin)
Au	Gold (pin)
Electrical connection at the sensor	
S	Plug for coax connector SN6
Internal thread	
E	PG 13.5

DULCOTEST® ORP sensor selection guide see page → 1-9

ORP Sensor RHES-Pt-SE



ORP sensor optimised for use in potable water treatment, swimming pools/hot tubs at up to 60 °C/3 bar

Your benefits

- Electrochemical combination electrode: ORP and reference electrode integrated
- Diaphragm and reference system optimised for use in swimming pools and for potable water
- Ceramic diaphragm with special material, optimised size and optimised pore diameter
- Long service life due to reduced diffusion ("bleeding") of the electrolyte
- Long service life due to the material, which is inert to aggressive disinfectants
- Stable reference system
- Rotating sensor head sleeve. This means that the cables can remain connected during installation and dismantling of the sensor, avoiding moisture on the plug-in contacts
- Lead-free glass for advanced and environmentally-friendly production, use and disposal (RoHS-compliant)

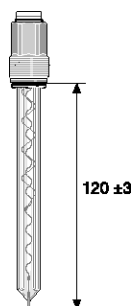

pk_6_031

Temperature	0 ... 60 °C
Max. pressure	3.0 bar
Min. conductivity	150 µS/cm
Electrolyte	Gel containing potassium chloride
ORP electrode	Platinum
Diaphragm	Ceramic
Sensor shaft	Glass
Shaft diameter	12 mm
Fitting length	120 ± 3 mm
Fitting position	Vertical up to +25°
Thread	PG 13.5
Electrical connection	SN6 plug-in head, rotatable with a ProMinent cable
Enclosure rating	IP 65
Installation	Bypass: open outlet or return of the sample water into the process line, inline: direct installation into the pipework; fixed or replaceable (replaceable fitting), tank, channel: Immersion in the immersion tube
Measuring and control equipment	All DULCOMETER® controllers and solenoid-driven metering pumps types D_4a and delta®
Typical applications	Swimming pools, whirlpools, potable water



1.2 pH, ORP, Fluoride and Temperature Sensors DULCOTEST®

Resistance to	Disinfectant
Measuring principle, technology	Direct potentiometric measurement, 2 electrodes, gel electrolyte, ceramic diaphragm

	Fitting length	Order no.
RHES-Pt-SE SLg100	100 ±3 mm	1051746
RHES-Pt-SE	120 ±3 mm	150703

ORP Sensor RHES-Au-SE

ORP sensor optimised for use in potable water treatment, swimming pools/hot tubs when electrolysis processes are used for disinfection and with ozone treatment at up to 60 °C/3 bar

Your benefits

- Electrochemical combination electrode: ORP and reference electrode integrated
- Gold electrode to prevent faults by products from electrolysis processes where the electrodes are immersed directly into the sample water
- Diaphragm and reference system optimised for use in swimming pools and for potable water
- Ceramic diaphragm with special material, optimised size and optimised pore diameter
- Long service life due to reduced diffusion ("bleeding") of the electrolyte
- Long service life due to material, which is inert to aggressive disinfectants
- Stable reference system
- Rotating sensor head sleeve. This means that the cables can remain connected during installation and dismantling of the sensor, avoiding moisture on the plug-in contacts
- Lead-free glass for advanced and environmentally-friendly production, use and disposal (RoHS-compliant)

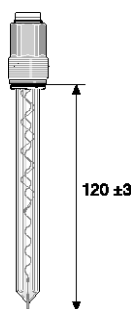

pk_6_031

Temperature	0 ... 60 °C
Max. pressure	3.0 bar
Min. conductivity	150 µS/cm
Electrolyte	Gel containing potassium chloride
ORP electrode	Gold
Diaphragm	Ceramic
Sensor shaft	Glass
Shaft diameter	12 mm
Fitting length	120 ±3 mm
Fitting position	Vertical up to +25°
Thread	PG 13.5
Electrical connection	SN6 plug-in head, rotatable with a ProMinent cable
Enclosure rating	IP 65
Installation	Bypass: open outlet or return of the sample water into the process line, inline: direct installation into the pipework; fixed or replaceable (replaceable fitting), tank, channel: Immersion in the immersion tube
Measuring and control equipment	All DULCOMETER® controllers and solenoid-driven metering pumps types D_4a and delta®
Typical applications	Swimming pools, whirlpools, potable water, with disinfectants from electrolysis processes (electrodes directly in the process water)
Resistance to	Disinfectant, by-products from electrolysis process and from ozone treatment process
Measuring principle, technology	Direct potentiometric measurement, 2 electrodes, gel electrolyte, ceramic diaphragm

	Order no.
RHES-Au-SE	1044544

1.2 pH, ORP, Fluoride and Temperature Sensors DULCOTEST®



ORP Sensor RHEP-Pt-SE

ORP sensor optimised for use with clear process water and conditions of up to 80 °C/6 bar

Your benefits

- Electrochemical combination electrode: ORP and reference electrode integrated
- Diaphragm and reference system optimised for exacting process requirements
- Ceramic diaphragm with special material, optimised size and optimised pore diameter
- Long service life due to reduced diffusion ("bleeding") of the electrolyte
- Long service life due to material, which is inert to aggressive chemicals
- Stable reference system for high pressure / temperature requirements
- Rotating sensor head sleeve. This means that the cables can remain connected during installation and dismantling of the sensor, avoiding moisture on the plug-in contacts
- Lead-free glass for advanced and environmentally-friendly production, use and disposal (RoHS-compliant)

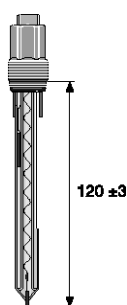

pk_6_035

Temperature	0 ... 80 °C
Max. pressure	6.0 bar
Min. conductivity	150 µS/cm
Electrolyte	Gel containing potassium chloride
ORP electrode	Platinum
Diaphragm	Ceramic
Sensor shaft	Glass
Shaft diameter	15 mm
Fitting length	120 ±3 mm
Fitting position	Vertical up to +25°
Thread	PG 13.5
Electrical connection	SN6 plug-in head, rotatable with a ProMinent cable
Enclosure rating	IP 65
Installation	Bypass: open outlet or return of the sample water into the process line, inline: direct installation into the pipework; fixed or replaceable (replaceable fitting), tank, channel: Immersion in the immersion tube
Measuring and control equipment	All DULCOMETER® controllers and solenoid-driven metering pumps types D_4a and delta®
Typical applications	Swimming pools during pressurisation for higher temperatures and pressures, potable and industrial water, electroplating,
Resistance to	Disinfectant, not suitable for media containing ozone, cyanides, electrolysis processes (electrodes directly in the sample water)
Measuring principle, technology	Direct potentiometric measurement, 2 electrodes, gel electrolyte, ceramic diaphragm

	Order no.
RHEP-Pt-SE	150094



1.2 pH, ORP, Fluoride and Temperature Sensors DULCOTEST®



ORP Sensor RHEP-Au-SE

ORP sensor optimised for use with clear process water when electrolysis processes are used for disinfection and with ozone treatment and with cyanide detoxification at conditions of up to 80 °C/6 bar

Your benefits

- Electrochemical combination electrode: ORP and reference electrode integrated
- Gold electrode to prevent faults by products from electrolysis processes where the electrodes are immersed directly into the sample water
- Diaphragm and reference system optimised for exacting process requirements
- Ceramic diaphragm with special material, optimised size and optimised pore diameter
- Long service life due to reduced diffusion ("bleeding") of the electrolyte
- Long service life due to the material, which is inert to aggressive chemicals
- Stable reference system for high pressure / temperature requirements
- Rotating sensor head sleeve. This means that the cables can remain connected during installation and dismantling of the sensor, avoiding moisture on the plug-in contacts
- Lead-free glass for advanced and environmentally-friendly production, use and disposal (RoHS-compliant)

Temperature	0 ... 80 °C
Max. pressure	6.0 bar
Min. conductivity	150 µS/cm
Electrolyte	Gel containing potassium chloride
ORP electrode	Gold
Diaphragm	Ceramic
Sensor shaft	Glass
Shaft diameter	15 mm
Fitting length	120 ±3 mm
Fitting position	Vertical up to +25°
Thread	PG 13.5
Electrical connection	SN6 plug-in head, rotatable with a ProMinent cable
Enclosure rating	IP 65
Installation	Bypass: open outlet or return of the sample water into the process line, inline: direct installation into the pipework; fixed or replaceable (replaceable fitting), tank, channel: Immersion in the immersion tube
Measuring and control equipment	All DULCOMETER® controllers and solenoid-driven metering pumps types D_4a and delta®
Typical applications	Cyanide detoxification, ozone monitoring
Resistance to	Disinfectant, by-products from electrolysis process and from ozone treatment process, cyanides
Measuring principle, technology	Direct potentiometric measurement, 2 electrodes, gel electrolyte, ceramic diaphragm

	Order no.
RHEP-Au-SE	1003875



1.2 pH, ORP, Fluoride and Temperature Sensors DULCOTEST®



ORP Sensor RHER-Pt-SE

ORP sensor optimised for use in contaminated water containing solids and for low conductivity of > 50 µS/cm at up to 80 °C/6 bar

Your benefits

- Electrochemical combination electrode: ORP and reference electrode integrated
- The large dirt-repellent Teflon® diaphragm prevents the reference system from becoming blocked up
- Long service life when solids are present
- High-viscosity electrolyte combined with a salt reservoir prevents the electrolyte from "bleeding"
- Long service life without drifts when there is clear water with low conductivity
- Rotating sensor head sleeve. This means that the cables can remain connected during installation and dismantling of the sensor, avoiding moisture on the plug-in contacts
- Lead-free glass for advanced and environmentally-friendly production, use and disposal (RoHS-compliant)

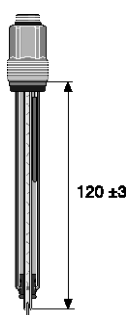

pk_6_034

Temperature	0 ... 80 °C
Max. pressure	6.0 bar
Min. conductivity	50 µS/cm
Electrolyte	Electrolyte with KCl supplement (salt rings in the reference electrolyte)
ORP electrode	Platinum
Diaphragm	PTFE ring diaphragm
Sensor shaft	Glass
Shaft diameter	12 mm
Fitting length	120 ± 3 mm
Fitting position	Vertical up to +25°
Thread	PG 13.5
Electrical connection	SN6 plug-in head/other versions on request
Enclosure rating	IP 65
Installation	Bypass: open outlet or return of the sample water into the process line, inline: direct installation into the pipework; fixed or replaceable (replaceable fitting), tank, channel: Immersion in the immersion tube
Measuring and control equipment	All DULCOMETER® controllers and solenoid-driven metering pumps types D_4a and delta®
Typical applications	Municipal and industrial waste water, cooling water, process water, chemical applications, paper manufacturing. In general for water with a noticeable solid fraction.
Resistance to	Disinfectant, solids content (turbid types of water)
Measuring principle, technology	Direct potentiometric measurement, 2 electrodes, Teflon ring diaphragm, polymer electrolyte

	Order no.
RHER-Pt-SE	1002534



1.2 pH, ORP, Fluoride and Temperature Sensors DULCOTEST®



ORP Sensor RHEX-Pt-SE

ORP sensor optimised for use with contaminated water with a high solids content at 6 bar/100 °C or 16 bar/25 °C

Your benefits

- Electrochemical combination electrode: ORP and reference electrode integrated
- Diaphragm and reference system optimised for extremely high solids content
- The solid electrolyte makes the diaphragm redundant and prevents the reference system from becoming blocked up
- Long service life when sludge is present due to lack of a diaphragm
- Long service life as the solid electrolyte prevents the electrolyte from "bleeding"
- Stable reference system
- Rotating sensor head sleeve. This means that the cables can remain connected during installation and dismantling of the sensor, avoiding moisture on the plug-in contacts
- Lead-free glass for advanced and environmentally-friendly production, use and disposal 1 (RoHS-compliant)

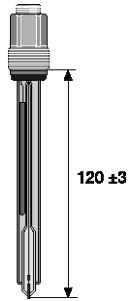

pk_6_033

Temperature	0 ... 100 °C
Max. pressure	16.0 bar up to 25 °C, 6.0 bar up to 100 °C
Min. conductivity	500 µS/cm
Electrolyte	Polymer containing potassium chloride (solid)
ORP electrode	Platinum
Diaphragm	Circular gap (solid electrolyte)
Sensor shaft	Glass
Shaft diameter	12 mm
Fitting length	120 ±3 mm
Fitting position	Vertical up to +25°
Thread	PG 13.5
Electrical connection	SN6 plug-in head/other versions on request
Enclosure rating	IP 65
Installation	Bypass: open outlet or return of the sample water into the process line, inline: direct installation into the pipework; fixed or replaceable (replaceable fitting), tank, channel: Immersion in the immersion tube
Measuring and control equipment	All DULCOMETER® controllers and solenoid-driven metering pumps types D_4a and delta®
Typical applications	Waste water, industrial water, process chemistry, emulsions, suspensions, protein-containing media. In general for water with a high solid fraction. Not suitable for clear media. Not suitable for media with oxidation agents.
Resistance to	Solids content (turbid types of water), sludge, emulsions
Measuring principle, technology	Direct potentiometric measurement, 2 electrodes, no diaphragm, polymer electrolyte

Order no.

RHEX-Pt-SE

305097



1.2 pH, ORP, Fluoride and Temperature Sensors DULCOTEST®



ORP Sensor RHEN-Pt-SE

Refillable ORP sensor optimised for use with chemically contaminated water at up to 80 °C/without excess pressure

Your benefits

- Electrochemical combination electrode: ORP and reference electrode integrated
- Renewable liquid electrolyte by continuous replenishment from an electrolyte bottle installed above the electrode
- 1 ceramic diaphragm made of special material, with an optimised size and with optimised pore diameter
- Long service life in the presence of chemicals dissolved in the water, which could contaminate the reference system
- Lead-free glass for advanced and environmentally-friendly production, use and disposal (RoHS-compliant)

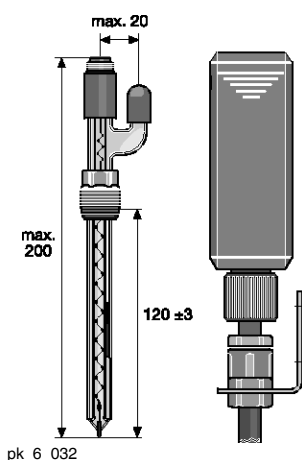

Temperature	0 ... 80 °C
Max. pressure	Operation at atmospheric pressure
Min. conductivity	150 µS/cm
Electrolyte	KCl electrolyte, refillable
ORP electrode	Platinum
Diaphragm	Ceramic
Sensor shaft	Glass
Shaft diameter	12 mm
Fitting length	120 ±3 mm
Fitting position	Vertical up to +25°
Thread	PG 13.5
Electrical connection	SN6 plug-in head/other versions on request
Enclosure rating	IP 65
Installation	By tripod or manually
Measuring and control equipment	All DULCOMETER® controllers and solenoid-driven metering pumps types D_4a and delta®
Typical applications	Waste water, cooling water, chemically contaminated water, only clear types of water
Resistance to	Disinfectant, chemicals dissolved in water
Measuring principle, technology	Direct potentiometric measurement, 2 electrodes, liquid electrolyte, 1 ceramic diaphragm

	Order no.
RHEN-Pt-SE	305091

Supplied without PE storage tank and tube

Accessories

	Capacity ml	Order no.
PE storage tank with connectors and tube	-	305058
KCl solution, 3 molar	250	791440
KCl solution, 3 molar	1,000	791441

We recommend installation approx. 0.5-1 m above the sample fluid level.



1.2 pH, ORP, Fluoride and Temperature Sensors DULCOTEST®



ORP Sensor RHEK-Pt-S

ORP sensor with plastic shaft for use with manual measuring instruments, optimised for use in potable water treatment, swimming pools/hot tubs at up to 60 °C/3 bar

Your benefits

- Electrochemical combination electrode: ORP and reference electrode integrated
- Diaphragm and reference system optimised for use in swimming pools and for potable water
- With plastic shaft to prevent glass breakage
- Mechanical protection of the glass diaphragm
- Ceramic diaphragm with special material, optimised size and optimised pore diameter
- Long service life due to reduced diffusion ("bleeding") of the electrolyte
- Long service life due to the material, which is inert to aggressive disinfectants
- Stable reference system
- Lead-free glass for advanced and environmentally-friendly production, use and disposal (RoHS-compliant)

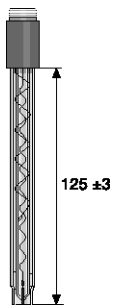

pk_6_036

Temperature	0 ... 60 °C
Max. pressure	Operation at atmospheric pressure
Min. conductivity	150 µS/cm
Electrolyte	Gel containing potassium chloride
ORP electrode	Platinum
Diaphragm	Ceramic
Sensor shaft	Polycarbonate
Shaft diameter	12 mm
Fitting length	125 ± 3 mm
Fitting position	Vertical up to +25°
Thread	None
Electrical connection	SN6 plug-in head, rotatable with a ProMinent cable
Enclosure rating	IP 65
Installation	By tripod or manually
Measuring and control equipment	All DULCOMETER® controllers and solenoid-driven metering pumps types D_4a and delta®
Typical applications	Manual measurement e.g. swimming pools, potable water, aquarium water
Resistance to	Disinfectant
Measuring principle, technology	Direct potentiometric measurement, 2 electrodes, gel electrolyte, ceramic diaphragm

Order no.

RHEK-Pt-S

305052

1.2 pH, ORP, Fluoride and Temperature Sensors DULCOTEST®

ORP Sensor RHEK-Pt-SE



ORP sensor with plastic shaft, optimised for use in potable water treatment, swimming pools/hot tubs at up to 60 °C/3 bar

Your benefits

- Electrochemical combination electrode: ORP and reference electrode integrated
- Diaphragm and reference system optimised for use in swimming pools and for potable water
- With plastic shaft to prevent glass breakage
- Mechanical protection of the glass diaphragm
- Ceramic diaphragm with special material, optimised size and optimised pore diameter
- Long service life due to reduced diffusion ("bleeding") of the electrolyte
- Long service life due to the material, which is inert to aggressive disinfectants
- Stable reference system
- Rotating sensor head sleeve. This means that the cables can remain connected during installation and dismantling of the sensor, avoiding moisture on the plug-in contacts
- Lead-free glass for advanced and environmentally-friendly production, use and disposal (RoHS-compliant)

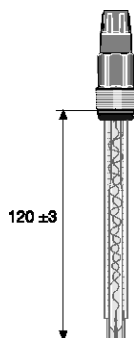

pk_6_091

Temperature	0 ... 60 °C
Max. pressure	3.0 bar
Min. conductivity	150 µS/cm
Electrolyte	Gel containing potassium chloride
ORP electrode	Platinum
Diaphragm	Ceramic
Sensor shaft	Polycarbonate
Shaft diameter	12 mm
Fitting length	120 ±3 mm
Fitting position	Vertical up to +25°
Thread	PG 13.5
Electrical connection	SN6 plug-in head, rotatable with a ProMinent cable
Enclosure rating	IP 65
Installation	Bypass: open outlet or return of the sample water into the process line, inline: direct installation into the pipework; fixed or replaceable (replaceable fitting), tank, channel: Immersion in the immersion tube
Measuring and control equipment	All DULCOMETER® controllers and solenoid-driven metering pumps types D_4a and delta®
Typical applications	Swimming pool, Potable water, Aquariums,
Resistance to	Disinfectant
Measuring principle, technology	Direct potentiometric measurement, 2 electrodes, gel electrolyte, ceramic diaphragm

RHEK-Pt-SE	Order no. 1028459
-------------------	-----------------------------



1.2 pH, ORP, Fluoride and Temperature Sensors DULCOTEST®



ORP Sensor RHEK-L Pt-SE

ORP sensor with plastic shaft, optimised for vertical to horizontal installation position for use in potable water treatment, swimming pools/hot tubs at up to 60 °C/3 bar

Your benefits

- Electrochemical combination electrode: ORP and reference electrode integrated
- With plastic shaft to prevent glass breakage
- Horizontal (level) installation possible (90° angle) (usually limited to 0 - 75° angle)
- Diaphragm and reference system optimised for use in swimming pools and for potable water
- Ceramic diaphragm with special material, optimised size and optimised pore diameter
- Long service life due to reduced diffusion ("bleeding") of the electrolyte
- Rotating sensor head sleeve. This means that the cables can remain connected during installation and dismantling of the sensor, avoiding moisture on the plug-in contacts
- Long service life due to the material, which is inert to aggressive disinfectants
- Stable reference system

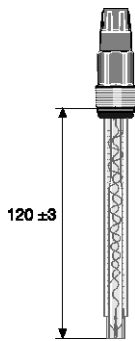

pk_6_091

Temperature	0 ... 60 °C
Max. pressure	3.0 bar
Min. conductivity	150 µS/cm
Electrolyte	Gel containing potassium chloride
ORP electrode	Platinum
Diaphragm	Ceramic
Sensor shaft	Polycarbonate
Shaft diameter	12 mm
Fitting length	120 ± 3 mm
Fitting position	vertical to horizontal
Thread	PG 13.5
Electrical connection	SN6 plug-in head, rotatable with a ProMinent cable
Enclosure rating	IP 65
Installation	Bypass: open outlet or return of the sample water into the process line, inline: direct installation into the pipework; fixed or replaceable (replaceable fitting), tank, channel: Immersion in the immersion tube
Measuring and control equipment	All DULCOMETER® controllers and solenoid-driven metering pumps types D_4a and delta®
Typical applications	Swimming pools, Potable water, Aquariums, Horizontal installation possible.
Resistance to	Disinfectant
Measuring principle, technology	Direct potentiometric measurement, 2 electrodes, gel electrolyte, ceramic diaphragm

Order no.

RHEK-L Pt-SE

1034919

1.2 pH, ORP, Fluoride and Temperature Sensors DULCOTEST®

1.2.4 ORP Sensors with Fixed Cable

All ORP sensors with fixed cable contain a shielded coaxial cable, which is firmly connected to the sensor head by a rotating sleeve. This prevents the cable from twisting when inserting and dismantling the sensor.

Series	
RHE	ORP sensor
Properties	
K	Plastic shaft
S	Swimming pool sensor
Sensor material	
Pt	Platinum
Electrical connection at the sensor	
F	Fixed cable sensor
Internal thread	
E	internal thread PG 13.5
Cable diameter	
3	cable diameter 3 mm
5	cable diameter 5 mm
Cable length	
01	cable length in metres
Electrical connection at device	
S	SN6
D	DIN
B	BNC

The technical data corresponds to pH sensors with SN6 plug-in head (see page → 1-33)

ORP Sensor RHES-Pt-FE



ORP sensor optimised for use in potable water treatment, swimming pools/hot tubs at up to 60 °C/3 bar

Your benefits

- Electrochemical combination electrode: ORP and reference electrode integrated
- Diaphragm and reference system optimised for use in swimming pools
- Ceramic diaphragm with special material, optimised size and optimised pore diameter
- Long service life due to reduced diffusion ("bleeding") of the electrolyte
- Long service life due to the material, which is inert to aggressive disinfectants
- Stable reference system
- Anti-twist mechanism on the fixed cable prevents the cable from twisting when inserting and removing the sensor
- Lead-free glass for advanced and environmentally-friendly production, use and disposal (RoHS-compliant)

	Cable length m	Device plug	Order no.
RHES-Pt-FE 301 B	1	BNC	150758
RHES-Pt-FE 303 B	3	BNC	150038
RHES-Pt-FE 301 S	3	SN6	304949

Other types on request.



1.2 pH, ORP, Fluoride and Temperature Sensors DULCOTEST®

1

ORP Sensor RHES-Pt-F

ORP sensor for use with manual measuring instruments, optimised for use in swimming pools / hot tubs at up to 60 °C / 3 bar

Your benefits

- Electrochemical combination electrode: ORP and reference electrode integrated
- Diaphragm and reference system optimised for use in swimming pools
- Ceramic diaphragm with special material, optimised size and optimised pore diameter
- Long service life due to reduced diffusion ("bleeding") of the electrolyte
- Long service life due to the material, which is inert to aggressive disinfectants
- Stable reference system
- Lead-free glass for advanced and environmentally-friendly production, use and disposal (RoHS-compliant)

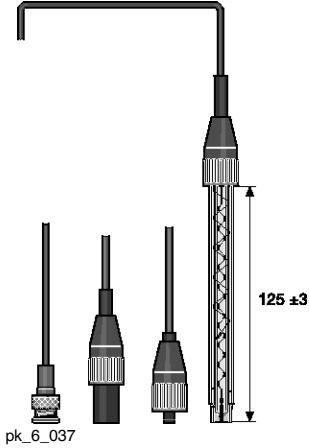

	Cable length m	Device plug	Order no.
RHES-Pt-F 303 B	3	BNC	304983

Other types on request.

ORP Sensor RHEK-Pt-F

ORP sensor with plastic shaft for use with manual measuring instruments, optimised for use in potable water treatment, swimming pools/hot tubs at up to 60 °C/3 bar

Your benefits

- Electrochemical combination electrode: ORP and reference electrode integrated
- Diaphragm and reference system optimised for use in swimming pools
- With plastic shaft to prevent glass breakage
- Mechanical protection of the glass diaphragm
- Ceramic diaphragm with special material, optimised size and optimised pore diameter
- Long service life due to reduced diffusion ("bleeding") of the electrolyte
- Long service life due to the material, which is inert to aggressive disinfectants
- Stable reference system
- Lead-free glass for advanced and environmentally-friendly production, use and disposal (RoHS-compliant)

	Cable length m	Device plug	Order no.
RHEK-Pt-F 301 S	1	SN 6	304997
RHEK-Pt-F 501 D	1	DIN	304998

Further types on request.



1.2 pH, ORP, Fluoride and Temperature Sensors DULCOTEST®

1.2.5 DULCOTEST® Fluoride Sensors

DULCOTEST® fluoride sensors are ion selective sensors, which function according to the potentiometric measuring principle and are suitable for determining the concentration of fluoride anions in aqueous solutions. The measuring point with the FPV1 type measuring transducer was optimised for use in monitoring the fluoridation of potable water in waterworks (measurement range up to 10 ppm). The measuring point with the measuring transducer FP 100 V1 with a measurement range up to 100 ppm is used for clear waste water free of solid material.

Fluoride Sensor FLEP 010-SE / FLEP 0100-SE

Highly selective, online fluoride sensor, optimised for the fluoridation of potable water and monitoring of waste water with a pH of up to 9.5



Your benefits

- Highly selective measurement of fluoride by LaF₃ single crystal silicon
- Unique pH range of up to pH 9.5 by optimisation of the electrolyte
- Two measuring ranges available: 0.05 -10 ppm for potable water; 0.5 -100 ppm for waste water

Technical Details

A 4-20 mA measuring transducer, a reference electrode and a temperature sensor for temperature compensation are required as well as the fluoride sensor.

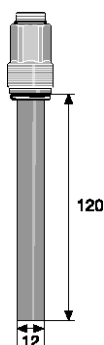

pk_6_095

Measured variable	Fluoride ion concentration
Reference method	Photometrically (Photometer DT2C)
Measuring range	With measuring transducer FPV1: 0.05...10 mg/l With measuring transducer FP100V1: 0.5...100 mg/l
pH range	5.5 ... 9.5
Temperature	1 ... 35 °C
Max. pressure	7.0 bar, (no pressure surges)
Min. conductivity	100 µS/cm
Shaft diameter	12.0 mm
Fitting length	120 mm
Thread	PG 13.5
Electrical connection	SN6 plug-in head
Enclosure rating	IP 65
Installation	Bypass: open outlet or return of the sample water into the process line, inline: direct installation into the pipework; fixed or replaceable (replaceable fitting), tank, channel: Immersion in the immersion tube
Intake flow	10...200 l/h
Flow	20 l/h (recommended)
Response time T95 max.	30 s (for conc. > 0.5 ppm)
Shelf life	6 months
In-line probe fitting	Bypass fitting DLG IV
Measuring and control equipment	D1C, DAC, DULCOMARIN®
Typical applications	Monitoring the fluoridation of potable water in waterworks Waste water
Resistance to	Disinfectant, solids content (turbid types of water)
Measuring principle, technology	Direct potentiometric measurement, 2 electrodes, gel electrolyte, ceramic diaphragm, separate temperature measurement for temperature compensation needed

Order no.

FLEP 010-SE / FLEP 0100-SE	1028279
-----------------------------------	---------

Note: Measuring ranges from 50 ... 1,000 mg/l and 500 ... 10,000 mg/l available on request.



1.2 pH, ORP, Fluoride and Temperature Sensors DULCOTEST®

Accessories

	Order no.
Measuring transducer 4-20 mA FPV1	1028280
Measuring transducer 4-20 mA FP 100 V1	1031331
Two-wire measuring line 2 x 0.25 mm ² Ø 4 mm	725122
Reference electrode REFP-SE	1018458
Pt 100 SE	305063
Polishing paste	559810

Panel-mounted fluoride measuring station

The panel-mounted measuring stations that could be ordered to date with part no.1010602 (230 V) and 1010603 (115 V) can now be ordered as measuring stations of the DULCOTROL® DWCa product line.

Overview of DULCOTROL® DWCa_Potable Water/F&B See page → 3-3

1.2.6 DULCOTEST® Temperature Sensors



Temperature measurement with DULCOTEST® sensors: Can be used for direct temperature measurement or temperature compensation during measurement of pH, fluoride, conductivity, chlorine dioxide or hydrogen peroxide.

Your benefits

- Select Pt 100 or Pt 1000, depending on measuring range and accuracy required.
- Sturdy design with dimensions of a standard pH sensor; the sensor element is integrated in a chemically inert glass sleeve.
- Easily installed in a similar way to standard pH sensors with a PG 13.5 thread in existing fittings.
- Transmitter with display/operation and without display/operation for transmission/conversion of the primary signal into a 4-20 mA signal and for transmission to a central control unit (PLC).

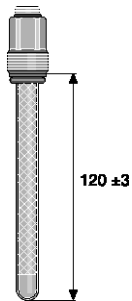

pk_6_026

Temperature	0 ... 100 °C
Max. pressure	10.0 bar
Thread	PG 13.5
Electrical connection	SN6
Typical applications	Temperature measurement and pH temperature correction

	Order no.
Pt 100 SE	305063
Pt 1000 SE	1002856



1.3 Amperometric Sensors DULCOTEST®

1.3.1

Amperometric Sensors for Chlorine, Bromine, Chlorine Dioxide, Chlorite, Ozone, Dissolved Oxygen, Peracetic Acid and Hydrogen Peroxide

The advantages at a glance:

- 12 measuring parameters available with analogue construction, each for simple installation to the same fittings and controllers
- Application-specific sensor models permit optimum operation with varying process conditions
- Efficient process management by precise measurement in real-time
- Amperometric measuring principle means no interference by turbidity or discolouration
- Diaphragm-covered measuring electrodes ensure reliable operation and long service life even under adverse and variable process conditions

Note the following points for optimum operation of amperometric sensors:

- Use of DULCOMETER® controllers
- Installation only in ProMinent fittings type DGM or DLG III
- Specified flow between 30...60 l/h
- Chlorine measurement only with a steady pH: if not possible, see Chapter 3.4
- Regular calibration with a photometer (e.g. type DT)

Important:

No amperometric sensors are galvanically isolated. When using with external devices (e.g. PLC), ensure that the supply voltage and analogue input signal are galvanically isolated.

Selection guide for DULCOTEST® amperometric sensors

Measured variable	Applications	Graduated measuring range	Connection to DULCOMETER®	Sensor type	See page
Free chlorine	Potable water, swimming pools	0.01–100 mg/l	D1C, DAC	CLE 3-mA-xppm, CLE 3.1-mA-xppm	→ 1-51
Free chlorine	Process and waste water	10 - 200 mg/l	D1C, DAC	CLR 1-mA	→ 1-63
Free chlorine	Potable water, swimming pool water	0.01 - 10 mg/l	DULCOMARIN®	CLE 3-CAN-xppm, CLE 3.1-CAN-xppm	→ 1-54
Free chlorine	Potable water, swimming pool water, in situ electrolysis (without diaphragm)	0.02-10 mg/l	D1C, DAC	CLO 2-mA-2ppm	→ 1-56
Free chlorine	Swimming pools, uncontaminated potable water and process water, and can also be used together with diaphragm-free electrolysis processes.	0.01-10 mg/l	DULCOMARIN®	CLO 2-mA-2ppm	→ 1-57
Free chlorine	Hot water up to 70 °C (legionella), in situ electrolysis (without diaphragm)	0.02-2 mg/l	D1C, DAC	CLO 2-mA-2ppm	→ 1-58
Free chlorine	Potable water, swimming pools	0.01–50 mg/l	DMT	CLE 3-DMT-xppm	→ 1-53
Free chlorine	Potable water, swimming pools	0.05-5 mg/l	COMPACT	CLB 2-µA-xppm	→ 1-59
Free chlorine	Potable water, swimming pool water	0.05-5 mg/l	COMPACT	CLB 3-µA-xppm	→ 1-60
Free chlorine	Cooling, industrial and waste water, water with higher pH values (stable); seawater (free chlorine exists as bromine)	0.01-10 mg/l	D1C, DAC	CBR 1-mA-xppm	→ 1-61
Total available chlorine	Swimming pool water with chlorine-organic disinfectants	0.02–10 mg/l	D1C, DAC	CGE 3-mA-xppm	→ 1-64
Total available chlorine	Swimming pool water with organic chlorine disinfectants, in situ electrolysis (without diaphragm)	0.02 - 10 mg/l	D1C, DAC	CGE 3-mA	→ 1-64
Total available chlorine	Swimming pool water with chlorine-organic disinfectants	0.01–10 mg/l	DULCOMARIN®	CGE 3-CAN-P-xppm	→ 1-65
Total chlorine	Potable, industrial, process and waste water	0.01–10 mg/l	D1C, DAC	CTE 1-mA-xppm	→ 1-66
Total chlorine	Potable, industrial, process and waste water	0.01–10 mg/l	DMT	CTE 1-DMT-xppm	→ 1-67
Total chlorine	Potable, industrial, process and waste water	0.01–10 mg/l	DULCOMARIN®	CTE 1-CAN-P-xppm	→ 1-68
Combined chlorine	Swimming pool water	0.02–2 mg/l	DAC	CTE 1-mA-2 ppm + CLE 3.1-mA-2 ppm	→ 1-68



1.3 Amperometric Sensors DULCOTEST®

Measured variable	Applications	Graduated measuring range	Connection to DULCOMETER®	Sensor type	See page
Combined chlorine	Swimming pool water	0.01–10 mg/l	DULCOMARIN®	CTE 1-CAN-P-xppm + CLE 3.1-CAN-xppm	→ 1-68
Total available bromine	Cooling water, waste water, swimming pool water, whirlpool water, bromine with BCDMH	0.01-10 mg/l	D1C, DAC	BCR 1-mA (replaces earlier type BRE 1)	→ 1-70
Total available bromine	Cooling water, swimming pool water, whirlpool water with organic or inorganic bromine compounds	0.02-10 mg/l	DULCOMARIN®	BRE 3-CAN-10 ppm	→ 1-71
Free and bound bromine	Cooling, industrial, waste water, water with higher pH values (stable); seawater	0.02-20 mg/l	D1C, DAC	CBR 1-mA-xppm	→ 1-61
Free + combined bromine	Cooling, industrial, waste water, water with higher pH values (stable); sea water	0.00-0 mg/l	D1C, DAC	CBR 1-mA-xppm	→ 1-62
Chlorine dioxide	Potable water	0.01–10 mg/l	D1C, DAC	CDE 2-mA-xppm	→ 1-74
Chlorine dioxide	Bottle washer systems	0.02–2 mg/l	D1C, DAC	CDP 1-mA	→ 1-75
Chlorine dioxide	Hot water up to 60 °C, cooling water, waste water, irrigation water	0.01-10 mg/l	D1C, DAC, DULCOMARIN®	CDR 1-mA-xppm, CDR 1-CAN-xppm	→ 1-76
Chlorite	Potable, wash water	0.02–2 mg/l	D1C, DAC, DULCOMARIN®	CLT 1-mA-xppm, CLT 1-CAN-xppm	→ 1-78
Ozone	Potable water, swimming pool water	0.02–2 mg/l	D1C, DAC	OZE 3-mA	→ 1-80
Ozone	Process, service or cooling water	0.02–2 mg/l	D1C, DAC	OZR 1-mA-2 ppm*	→ 1-81
Dissolved oxygen	Potable, surface water	2–20 mg/l	D1C, DAC	DO 1-mA-xppm	→ 1-82
Dissolved oxygen	Activated sludge tank, sewage treatment plants	0.1–10 mg/l	D1C, DAC	DO 2-mA-xppm	→ 1-83
Peracetic acid	CIP, antiseptic food filling process	1–2,000 mg/l	D1C, DAC	PAA 1-mA-xppm	→ 1-84
Hydrogen peroxide	Clear water, fast control	1–2,000 mg/l	DAC	PEROX sensor PEROX-H2.10 P	→ 1-86
Hydrogen peroxide	Process, swimming pool water	2–20,000 mg/l	D1C, DAC	PER1-mA-xppm	→ 1-86



1.3 Amperometric Sensors DULCOTEST®

1.3.2

Sensors for Chlorine

Different forms of dissolved chlorine are present in water:

Free (effective) chlorine:	Recommended sensors for Cl ₂ , HOCl (hypochlorous acid), OCl ⁻ (hypochlorite): Types CLE, CLO, CLB, CBR, reference method: DPD1
Combined chlorine:	Mono-, di-, trichloroamine. The measuring result of type CLE (free chlorine) is subtracted from the measurement result of type CTE (total chlorine). Reference method: DPD4 minus DPD1
Total chlorine:	Total of free and combined chlorine; recommended sensor: Type CTE, reference method DPD4
Total available chlorine (organic combined chlorine):	Chlorine bound to (iso)cyanic acid/isocyanurate and the free (effective) chlorine resulting from it; recommended sensor: Type CGE, reference method DPD1
Applications:	Chlorine measurement in potable, swimming pool, cooling, service, process and waste water or water of comparable quality, as well as salt water/seawater with up to 15% chloride content. For chlorine measurements at high pH values (8...9.5), we recommend chlorine sensors CGE and CTE for total chlorine and total available chlorine. We recommend the sensor type CBR or the system for metering pH buffer solution into the sample water bypass (see Chapter 3.4) for measuring free chlorine at high pH values
Unit connection:	Do not use sensors CLE CLO, CLB and CBR in the presence of isocyanuric acid/chlorine stabilisers! Types CLE 3.1, CBR, CTE and CGE 2 operate incorrectly when chlorinating using electrolysis processes without diaphragm. Sensors with the designation -mA are used for controllers D1Cb, DAC and DULCOMARIN®. Sensors with the designation -4P are used for the former WS controllers and for metering pumps with integral chlorine controllers. Sensors with the designation DMT are used for DMT transducers. Sensors with the designation CAN are used with the swimming pool controller DULCOMARIN®. Sensors CLB 1 and CLB 2 with the designation -µA do not have a signal transformer and function solely with the Compact Controller.



1.3 Amperometric Sensors DULCOTEST®

Selection Guide

		CLE 3/ [CLR 1]	CLE 3.1	CLO 1	CLO 2	CLB 2/ CLB 3	CBR 1	CGE 3	CTE 1	BCR 1
Measured variable	Free chlorine	x, [x]	x	x	x	x	x ¹⁾			
	Total available chlorine (cyanuric acid derivatives)							x		
	Total chlorine								x	x ²⁾
Selectivity of free chlorine	Raised		x				x			
	Yes	x, [x]		x	x	x		x		
	No								x	x
Application	Public swimming pools	x	x	x		(x)	x	x	x ³⁾	
	Private swimming pools	x	x	x		x		x	x ³⁾	x ⁴⁾
	Potable water	x	x		x	x	x		x	
	Cooling water						x			x
	Waste water	[x]					x		x	x
Disinfectant	Chlorine gas, hypochlorite, electrolysis (with diaphragm)	x, [x]	x	x	x	x	x	x	x	
	Electrolysis (without membrane)	x, ([x])		x	x	x		x		
	Chlorine-containing cyanuric acid derivatives							x		
	BCDMH									x
Specifications	Measuring range [ppm]	0.01-100, [10-200]	0.01-10	0.02-10	0.02-2	0.05-5	0.01-10	0.02-10	0.01-10	0.01-10
	pH range	5.5-8.0	5.5-8.0	5.0-9.0	5.0-9.0	5.0-9.0	5.0-9.5	5.5-9.5	5.5-9.5	5.0-9.5
	Temperature [°C]	5-45	5-45	5-45	5-70	5-45	5-45	5-45	5-45	5-45
	Max. pressure [bar]	1	1	8	8	3	1	3	3	1
Installation	Open outlet	x	x	x	x	x	x	x	x	x
	Direct installation in the circuit			x	x	x				

1) as well as free and combined bromine (see Chap. 1.3.6: "Bromine Sensors")

2) as well as total available bromine (see Chap. 1.3.6: "Bromine Sensors")

3) in combination with the Sensor for Free Chlorine type CBR 1 for determining combined chlorine

4) and pools on cruise ships



1.3 Amperometric Sensors DULCOTEST®

1.3.3 DULCOTEST® Sensors for Free Chlorine



Sensor for Free Chlorine CLE 3-mA

Standard sensor for measuring free chlorine in clear water. For operation on controllers with 4-20 mA input

Your benefits

- Measured variable: free chlorine, no significant cross sensitivity to combined chlorine (chloramines)
- Diaphragm-covered sensor (encapsulated) minimises faults caused by changing flow or ingredients in the water

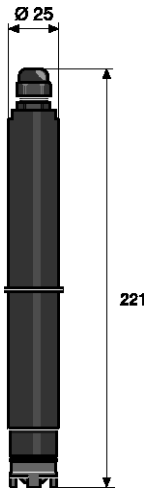

pk_6_039

Measured variable	free chlorine
Reference method	DPD1
pH range	5.5 ... 8.0
Temperature	5 ... 45 °C
Max. pressure	1.0 bar
Intake flow	30...60 l/h (in DGM or DLG III)
Supply voltage	16...24 V DC (two-wire technology)
Output signal	4...20 mA ≈ measuring range, temperature-compensated, uncalibrated, not electrically isolated
Selectivity	Free chlorine as against combined chlorine, even if there is not an excess of it
Disinfection process	Chlorine gas, hypochlorite, electrolysis with diaphragm, disinfectants with organic chlorine, e. g. based on cyanuric acid, are unsuitable
Installation	Bypass: offener Auslass des Messwassers
Sensor fitting	DGM, DLG III
Measuring and control equipment	D1Cb, DAC, delta® solenoid-driven diaphragm metering pump
Typical applications	CLE 3-mA-0.5 ppm: potable water; CLE 3-mA-2.0/10 ppm: swimming pools (surfactant-free)
Resistance to	Salts, acids, alkalis. Not surfactants
Measuring principle, technology	Amperometric, 2 electrodes, membrane-covered

	Measuring range	Order no.
CLE 3-mA-0.5 ppm	0.01...0.5 mg/l	792927
CLE 3-mA-2 ppm	0.02...2.0 mg/l	792920
CLE 3-mA-5 ppm	0.05...5.0 mg/l	1033392
CLE 3-mA-10 ppm	0.10...10.0 mg/l	792919
CLE 3-mA-20 ppm	0.20...20.0 mg/l	1002964
CLE 3-mA-50 ppm	0.50...50.0 mg/l	1020531
CLE 3-mA-100 ppm	1.00...100.0 mg/l	1022786

Chlorine sensors complete with 100 ml of electrolyte

A mounting kit, order no. 815079, is required for initial fitting of the chlorine sensors in the in-line probe housing DLG III.



1.3 Amperometric Sensors DULCOTEST®



Sensor for Free Chlorine CLE 3.1-mA

Sensor for the measurement of free chlorine in clear water with higher selectivity towards combined chlorine. For use on controllers with 4-20 mA input

Your benefits

- Measured variable: free chlorine, no cross sensitivity to combined chlorine (chloramines), even if there is an excess of it
- Diaphragm-covered sensor (encapsulated) minimises faults caused by changing flow or ingredients in the water

Measured variable

Free chlorine (hypochlorous acid HOCl) with high levels of combined chlorine; for determining the combined chlorine with a DAC controller and sensor for total chlorine type CTE 1-mA

Reference method

DPD1

pH range

5.5 ... 8.0

Temperature

5 ... 45 °C

Max. pressure

1.0 bar

Intake flow

30...60 l/h (in DGM or DLG III)

Supply voltage

16...24 V DC (two-wire technology)

Output signal

4...20 mA ≈ measuring range, temperature-compensated, uncalibrated, not electrically isolated

Selectivity

Free chlorine as against combined chlorine, even if there is an excess of it

Disinfection process

Chlorine gas, hypochlorite, electrolysis with diaphragm, disinfectants with organic chlorine, e. g. based on cyanuric acid, are unsuitable

Installation

Bypass: offener Auslass des Messwassers

Sensor fitting

DGM, DLG III

Measuring and control equipment

D1Cb, DAC, delta® solenoid-driven diaphragm metering pump

Typical applications

Potable water with higher volumes of combined chlorine
Swimming pools. To determine the combined chlorine from the difference:
Total chlorine minus free chlorine in the controller DAC

Resistance to

Salts, acids, alkalis. Not surfactants

Measuring principle, technology

Amperometric, 2 electrodes, membrane-covered

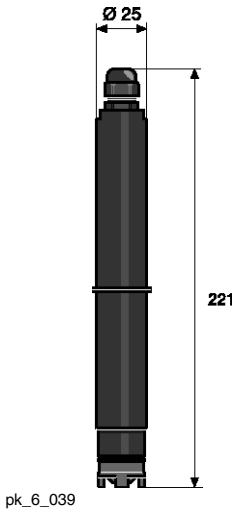

pk_6_039

	Measuring range	Order no.
CLE 3.1-mA-0.5 ppm	0.01...0.5 mg/l	1020530
CLE 3.1-mA-2 ppm	0.02...2.0 mg/l	1018369
CLE 3.1-mA-5 ppm	0.05...5.0 mg/l	1019398
CLE 3.1-mA-10 ppm	0.10...10.0 mg/l	1018368

Chlorine sensors complete with 100 ml of electrolyte

A mounting kit, order no. 815079, is required for initial fitting of the chlorine sensors in the in-line probe housing DLG III.

Signal leads see Sensor Accessories, p. → 1-119



1.3 Amperometric Sensors DULCOTEST®



Sensor for Free Chlorine CLE 3-DMT

Standard sensor for measuring free chlorine in clear water. For operation on ProMinent transmitters type DMT

Your benefits

- Measured variable: free chlorine, no significant cross sensitivity to combined chlorine (chloramines)
- Diaphragm-covered sensor (encapsulated) minimises faults caused by changing flow or ingredients in the water

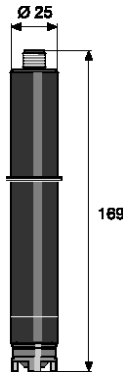

pk_6_038

Measured variable	free chlorine
Reference method	DPD1
pH range	5.5 ... 8.0
Temperature	5 ... 45 °C
Max. pressure	1.0 bar
Intake flow	30...60 l/h (in DGM or DLG III)
Supply voltage	3.3 V DC (5 P)
Output signal	0...1 V DC, uncalibrated, not temperature compensated, not electrically isolated
Temperature measurement	About the integrated Pt 1000. The temperature compensation is carried out in DMT.
Selectivity	Free chlorine as against combined chlorine, even if there is not an excess of it
Disinfection process	Chlorine gas, hypochlorite, electrolysis with diaphragm, disinfectants with organic chlorine, e. g. based on cyanuric acid, are unsuitable
Installation	Bypass: offener Auslass des Messwassers
Sensor fitting	DGM, DLG III
Measuring and control equipment	DMT
Typical applications	CLE 3-mA-0.5 ppm: potable water; CLE 3-mA-2.0/10 ppm: swimming pools (surfactant-free)
Resistance to	Salts, acids, alkalis. Not surfactants
Measuring principle, technology	Amperometric, 2 electrodes, membrane-covered

	Measuring range	Order no.
CLE 3-DMT-5 ppm	0.01...5.0 mg/l	1005511
CLE 3-DMT-50 ppm	0.10...50.0 mg/l	1005512

Chlorine sensors complete with 100 ml of electrolyte

A mounting kit, order no. 815079, is required for initial fitting of the chlorine sensors in the in-line probe housing DLG III.

Signal leads see Sensor Accessories, p. → 1-119



1.3 Amperometric Sensors DULCOTEST®



Sensor for free chlorine CLE 3-CAN-P

Standard sensor for measuring free chlorine in clear water. For use on controllers with CAN-bus connection

Your benefits

- Measured variable: free chlorine, no significant cross sensitivity to combined chlorine (chloramines)
- Diaphragm-covered sensor (encapsulated) minimises faults caused by changing flow or ingredients in the water
- Operation on the CAN-bus with all the associated benefits

Measured variable	free chlorine
Reference method	DPD1
pH range	5.5 ... 8.0
Temperature	5 ... 45 °C
Max. pressure	1.0 bar
Intake flow	30...60 l/h (in the DGM or DLG III)
Supply voltage	Via CAN interface (11 - 30 V)
Output signal	Uncalibrated, temperature compensated, electrically isolated
Selectivity	Free chlorine as against combined chlorine, even if there is not an excess of it
Disinfection process	Chlorine gas, hypochlorite, electrolysis with diaphragm, disinfectants with organic chlorine, e. g. based on cyanuric acid, are unsuitable
Installation	Bypass: open sample water outlet
Sensor fitting	DGM, DLG III
Measuring and control equipment	DULCOMARIN®
Typical applications	Potable water, swimming pool water
Resistance to	Salts, acids, alkalis. Not surfactants
Measuring principle, technology	Amperometric, 2 electrodes, membrane-covered

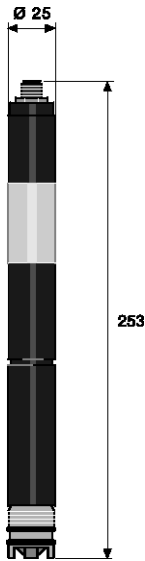

pk_6_096

	Measuring range	Order no.
CLE 3-CAN-P-10 ppm	0.01...10.0 mg/l	1083209

Chlorine sensors complete with 100 ml of electrolyte

A mounting kit, order no. 815079, is required for initial fitting of the chlorine sensors in the in-line probe housing DLG III.



1.3 Amperometric Sensors DULCOTEST®

Sensor for free chlorine CLE 3.1-CAN-P



Sensor for the measurement of free chlorine in clear water with higher selectivity towards combined chlorine. For use on controllers with CAN-bus connection

Your benefits

- Measured variable: free chlorine, no cross sensitivity to combined chlorine (chloramines) even if there is an excess of it
- Diaphragm-covered sensor (encapsulated) minimises faults caused by changing flow or ingredients in the water
- Operation on the CAN-bus with all the associated benefits

Measured variable

free chlorine with high levels of combined chlorine; for determining the combined chlorine with a DULCOMARIN® 3 and sensor for total chlorine type CTE 1-CAN

Reference method

DPD1

pH range

5.5 ... 8.0

Temperature

5 ... 45 °C

Max. pressure

1.0 bar

Intake flow

30...60 l/h (in DGMa or DLG III)

Supply voltage

Via CAN interface (11 – 30 V)

Output signal

Uncalibrated, temperature compensated, electrically isolated

Selectivity

Free chlorine

Disinfection process

Chlorine gas, hypochlorite, electrolysis with diaphragm, disinfectants with organic chlorine, e. g. based on cyanuric acid, are unsuitable

Installation

Bypass: open sample water outlet

Sensor fitting

DGM, DLG III

Measuring and control equipment

DULCOMARIN®

Typical applications

Potable water with higher percentages of combined chlorine; Swimming pool. To determine the combined chlorine from the difference: Total chlorine minus free chlorine in the controller DULCOMARIN®

Resistance to

Salts, acids, alkalis. Not surfactants

Measuring principle, technology

Amperometric, 2 electrodes, membrane-covered

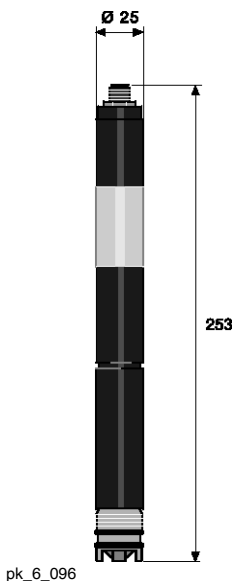

pk_6_096

	Measuring range	Order no.
CLE 3.1-CAN-P-10 ppm	0.01...10.0 mg/l	1083584

Chlorine sensors complete with 100 ml of electrolyte

A mounting kit, order no. 815079, is required for initial fitting of the chlorine sensors in the in-line probe housing DLG III.



1.3 Amperometric Sensors DULCOTEST®



Sensor for Free Chlorine CLO 1-mA

Sensor for the measurement of free chlorine in clear water even when using electrolysis processes for disinfection, up to 45 °C (1 bar) or 8 bar (25 °C). For use with controllers with 4-20 mA input

Your benefits

- Measured variable: free chlorine, no significant cross sensitivity to combined chlorine (chloramines)
- Use with return of the sample water to the process line
- Use at higher pressures
- Minimisation of faults by electrolysis systems in which the electrodes are immersed directly into the sample water (without diaphragm) by open sensor (no diaphragm) and gold electrodes
- Measurement of free chlorine up to pH 9

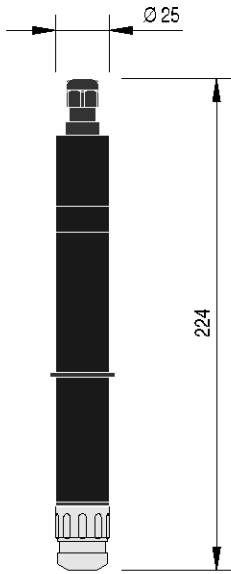

P_DT_0072_SW1

Measured variable	free chlorine
Reference method	DPD1
pH range	5.0 ... 9.0
Temperature	5 ... 45 °C
Max. pressure	8.0 bar (25 °C)
Intake flow	30...60 l/h (in DGM or DLG III), constant flow as flow-dependent signal
Supply voltage	16...24 V DC (2-wire)
Output signal	4...20 mA = Measuring range, temperature-compensated, uncalibrated, not electrically isolated
Selectivity	Free chlorine as against combined chlorine
Disinfection process	Chlorine gas, hypochlorite, electrolysis with diaphragm, electrolysis without diaphragm with electrodes in the process
Installation	Bypass: open outlet or return of the sample water into the process line, inline: direct installation into the tubes with the INLI fitting
Sensor fitting	DLG up to 1 bar/55 °C; DGM up to 6 bar/30 °C; INLI up to 7 bar/40 °C
Measuring and control equipment	D1Cb, DAC, delta® solenoid-driven diaphragm metering pump
Typical applications	Swimming pools, uncontaminated potable water and industrial service water, and can also be used together with diaphragm-free electrolysis processes. Can also be used in conjunction with hydrodynamic cleaning even in contaminated water.
Resistance to	surfactants
Measuring principle, technology	Amperometric, 3 electrodes, without diaphragm

	Measuring range	Order no.
CLO 1-mA-2 ppm	0.02...2.0 mg/l	1033871
CLO 1-mA-10 ppm	0.10...10.0 mg/l	1033870



1.3 Amperometric Sensors DULCOTEST®

Sensor for free chlorine CLO 1-CAN-P

Sensor for the measurement of free chlorine in clear water even when using electrolysis processes for disinfection, up to 45 °C (1 bar) or 8 bar (25 °C). For use on controllers with CAN-bus connection.



NEW

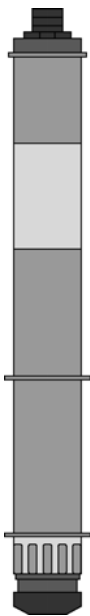

P_DT_0077_SW

Your benefits

- Measured variable: free chlorine, no significant cross sensitivity to combined chlorine (chloramines)
- Use with return of the sample water to the process line
- Use at higher pressures
- Minimisation of faults by electrolysis systems in which the electrodes are immersed directly into the sample water (without diaphragm) by open sensor (no diaphragm) and gold electrodes
- Measurement of free chlorine up to pH 9

Measured variable	Free chlorine
Reference method	DPD1
pH range	5.0 ... 9.0
Temperature	5 ... 45 °C
Max. pressure	8.0 bar (25 °C)
Intake flow	30...60 l/h (in DGM or DLG III), constant flow as flow-dependent signal
Supply voltage	11...30 V (via CAN interface)
Output signal	digital (CANopen), uncalibrated, temperature-compensated, galvanically isolated
Selectivity	Free chlorine as against combined chlorine
Disinfection process	Chlorine gas, hypochlorite, electrolysis with diaphragm, electrolysis without diaphragm with electrodes in the process
Installation	Bypass: open outlet or return of the sample water into the process line, inline: direct installation into the tubes with the INLI fitting
Sensor fitting	DLG up to 1 bar/55 °C; DGM up to 6 bar/30 °C; INLI up to 7 bar/40 °C
Measuring and control equipment	DULCOMARIN®
Typical applications	Swimming pool, uncontaminated drinking water and process water, and can also be used together with diaphragm-free electrolysis processes. Can also be used in conjunction with hydrodynamic cleaning even in contaminated water.
Resistance to	Salts, acids, alkalis, surfactants, dirt films
Measuring principle, technology	Amperometric, 3 electrodes, without diaphragm

	Measuring range	Order no.
CLO 1-CAN-P-10 ppm	0.10...10.0 mg/l	1083134



1.3 Amperometric Sensors DULCOTEST®



Sensor for Free Chlorine CLO 2-mA

Sensor for the measurement of free chlorine in clear water even when using electrolysis processes for disinfection, up to 70 °C or 8 bar (25 °C). For use with controllers with 4-20 mA input

Your benefits

- Measured variable: free chlorine, no significant cross sensitivity to combined chlorine (chloramines)
- Use with return of the sample water to the process line
- Use at higher pressures/temperatures
- Minimisation of faults by electrolysis systems in which the electrodes are immersed directly into the sample water (without diaphragm) by open sensor (no diaphragm) and gold electrodes
- Measurement of free chlorine up to pH 9

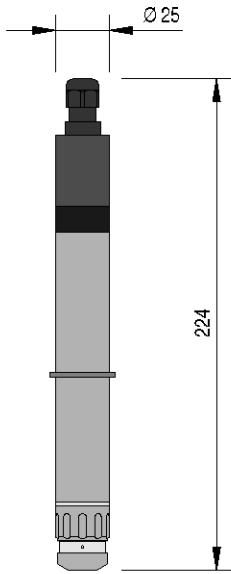

P_DT_0073_SW1

Measured variable	free chlorine
Reference method	DPD1
pH range	5.0 ... 9.0
Temperature	5 ... 70 °C
Max. pressure	8.0 bar (25 °C)
Intake flow	30...60 l/h (in DGM or DLG III), constant flow as flow-dependent signal
Supply voltage	16...24 V DC (2-wire)
Output signal	4...20 mA = Measuring range, temperature-compensated, uncalibrated, not electrically isolated
Selectivity	Free chlorine as against combined chlorine
Disinfection process	Chlorine gas, hypochlorite, electrolysis with diaphragm, electrolysis without diaphragm with electrodes in the process
Installation	Bypass: open outlet or return of the sample water into the process line, inline: direct installation into the tubes with the INLI fitting
Sensor fitting	DLG up to 1 bar/55 °C; DGM up to 1 bar/60 °C; INLI up to 2 bar/70 °C. Prerequisite: constant flow
Measuring and control equipment	D1Cb, DAC, delta® solenoid-driven diaphragm metering pump
Typical applications	Hot water up to 70 °C, combating legionella, uncontaminated potable water and industrial service water, can also be used together with diaphragm-free electrolysis processes
Resistance to	surfactants
Measuring principle, technology	Amperometric, 3 electrodes, without diaphragm

	Measuring range	Order no.
CLO 2-mA-2 ppm	0.02...2.0 mg/l	1033878



1.3 Amperometric Sensors DULCOTEST®



Sensor for Free Chlorine CLB 2-µA

Cost-effective, simple sensor for the measurement of free chlorine in clear water, even with a changing media temperature. Use even when electrolysis processes are used for disinfection at up to 45 °C/3 bar. For operation with the Compact controller DCCa

Your benefits

- Measured variable: free chlorine, no significant cross sensitivity to combined chlorine (chloramines)
- Cost-effective due to its simple construction without separate wear parts
- Simple, cost-effective maintenance without handling of the diaphragm caps
- Minimisation of faults by electrolysis systems without diaphragm in which the electrodes are immersed directly into the sample water by an open sensor (no diaphragm)
- Measurement of free chlorine up to pH 9 and use at high pressure of up to 8 bar by the absence of a diaphragm

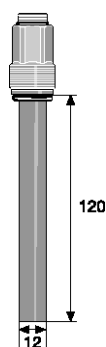

pk_6_095

Measured variable	free chlorine
Measuring range	0.05 – 5.0 mg/l, can be used for short-term shock chlorination up to 10 mg/l
Reference method	DPD1
pH range	5.0 ... 9.0
Temperature	5 ... 45 °C
Max. pressure	3.0 bar
Intake flow	30...60 l/h (in DGMA), constant flow needed as flow-dependent signal
Supply voltage	Only for compact controllers
Output signal	Non-amplified primary current signal, not temperature-compensated, uncalibrated, not electrically isolated
Temperature measurement	Pt 1000, integrated, calculation in the compact controller
Selectivity	Free chlorine as against combined chlorine
Disinfection process	Chlorine gas, hypochlorite, electrolysis with diaphragm, electrolysis without diaphragm with electrodes in the process
Installation	Bypass: open sample water outlet, inline: direct installation into the pipework
Sensor fitting	Chlorine gas, hypochlorite, electrolysis with diaphragm, electrolysis without diaphragm with electrodes in the process
Electrical connection	Fixed cable, 1 m, 6 wires with cable end sleeves
Measuring and control equipment	Compact controller
Typical applications	Swimming pools, potable water, can also be used with membrane-free chlorine production electrolysis processes, even with varying media temperatures
Resistance to	surfactants
Measuring principle, technology	Amperometric, 3 electrodes, without diaphragm

	Measuring range	Order no.
CLB 2-µA-5 ppm	0.05...5.0 mg/l	1038902



1.3 Amperometric Sensors DULCOTEST®



Sensor for Free Chlorine CLB 3-µA

Cost-effective, simple sensor for the measurement of free chlorine in clear water when the media temperature is constant. Use even when electrolysis processes are used for disinfection at up to 45 °C/3 bar. For operation with the Compact controller DCCa

Your benefits

- Measured variable: free chlorine, no significant cross sensitivity to combined chlorine (chloramines)
- Cost-effective due to its simple construction without separate wear parts
- Simple, cost-effective maintenance without handling of the diaphragm caps
- Minimisation of faults by electrolysis systems without diaphragm in which the electrodes are immersed directly into the sample water by an open sensor (no diaphragm)
- Measurement of free chlorine up to pH 9 and use at high pressure of up to 8 bar by the absence of a diaphragm

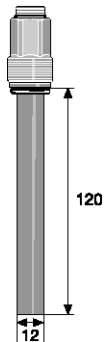

pk_6_095

Measured variable	free chlorine
Measuring range	0.05 - 5.0 mg/l: linear, can be used for shock chlorination up to 10.0 mg/l
Reference method	DPD1
pH range	5.0 ... 9.0
Temperature	5 ... 45 °C constant temperature needed, as temperature-dependent signal
Max. pressure	3.0 bar
Intake flow	30...60 l/h (in DGMA), constant flow necessary, as flow-dependent signal
Supply voltage	Only for compact controllers
Output signal	Non-amplified primary current signal, not temperature-compensated, uncalibrated, not electrically isolated
Temperature measurement	None
Selectivity	Free chlorine as against combined chlorine
Disinfection process	Chlorine gas, hypochlorite, electrolysis with diaphragm, electrolysis without diaphragm with electrodes in the process
Installation	Bypass: open sample water outlet, inline: direct installation into the pipework; fixed or replaceable (replaceable fitting)
Sensor fitting	DGM, DLG III
Electrical connection	Fixed cable, 1 m, 4 wires with cable end sleeves
Measuring and control equipment	Compact controller
Typical applications	Swimming pools, potable water, can also be used with membrane-free chlorine production electrolysis processes
Resistance to	surfactants
Measuring principle, technology	Amperometric, 3 electrodes, without diaphragm

	Measuring range	Order no.
CLB 3-µA-5 ppm	0.05...5.0 mg/l	1041696



1.3 Amperometric Sensors DULCOTEST®

Sensor for Free Chlorine CBR 1-mA



Sensor for free chlorine and bromine in contaminated water, also suitable for high pH values of up to 9.5. For use with controllers with 4-20 mA input

Your benefits

- Measured variable: free chlorine as well as free and combined bromine (bromamines)
- Diaphragm-covered sensor minimises faults caused by changing flow or ingredients in the water
- Resistance to films of dirt and biofilms by electrolyte with antimicrobial effect and large-pore diaphragm
- Use at high pH value of up to 9.5 by optimisation of the electrolyte diaphragm system

Measured variable

free chlorine, free bromine, combined bromine, DBDMH (1.3-dibrom-5,5-dimethyl-hydantoin)

Reference method

DPD1

pH-range

5 ... 9.5

Temperature

5 ... 10 °C

Max. pressure

1.0 bar

Intake flow

30...60 l/h (in DGM, DLG II)

Supply voltage

16...24 V DC (2-wire)

Output signal

4...20 mA = Measuring range, temperature-compensated, uncalibrated, not electrically isolated

Selectivity

Free chlorine as against combined chlorine

Disinfection process

Chlorine gas, hypochlorite, electrolysis with diaphragm, bromide + hypochlorite, DBDMH

Installation

Bypass: open sample water outlet

Sensor fitting

DGM, DLG III

Measuring and control equipment

D1Cb, DAC, delta® solenoid-driven diaphragm metering pump

Typical applications

Cooling water, process water, waste water, Water with higher pH values (stable pH), contaminated swimming pool water. Raw water for drinking water treatment. Rohwasser zur Trinkwasseraufbereitung.

Resistance to

Salts, acids, alkalis, surfactants, dirt films

Measuring principle, technology

Amperometric, 2 electrodes, membrane-covered

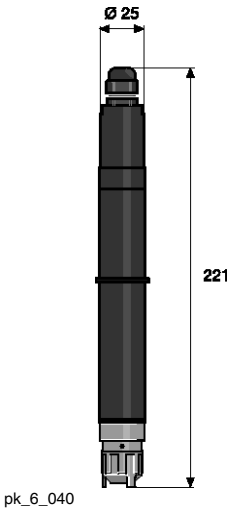

pk_6_040

	Measuring range	Order no.
CBR 1-mA-0.5 ppm	0.01...0.5 mg/l...*	1038016
CBR 1-mA-2 ppm	0.02...2.0 mg/l...*	1038015
CBR 1-mA-5 ppm	0.05...5.0 mg/l...*	1052138
CBR 1-mA-10 ppm	0.10...10.0 mg/l...*	1038014

* Measuring range based on chlorine. When measuring bromine, the lower and upper limit of the measuring range are increased by the factor 2.25, therefore for example CBR 1-mA-0.5ppm: 0.02 ...1.1 ppm.



1.3 Amperometric Sensors DULCOTEST®

Sensor for free and combined bromine CBR 1-CAN-P

Sensor for free chlorine and bromine in contaminated water, also suitable for high pH values of up to 9.5. For use on controllers with CAN-bus connection.

Your benefits

- Measured variable: free chlorine as well as free and combined bromine (bromamines)
- Diaphragm-covered sensor minimises faults caused by changing flow or ingredients in the water
- Resistance to films of dirt and biofilms by electrolyte with antimicrobial effect and large-pore diaphragm
- Use at high pH value of up to 9.5 by optimisation of the electrolyte diaphragm system

NEW

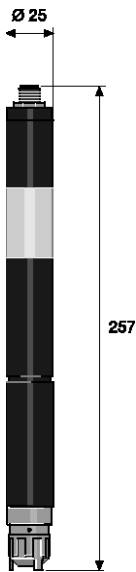

pk_6_084

Measured variable	free chlorine, free bromine, combined bromine, DBDMH (1.3-dibrom-5,5-dimethyl-hydantoin)
Reference method	DPD1
pH-range	5 ... 9.5
Temperature	5 ... 45 °C
Max. pressure	1.0 bar
Intake flow	30...60 l/h (in DGM, DLG II)
Supply voltage	11...30 V DC (via CAN interface)
Output signal	digital (CANopen), uncalibrated, temperature-compensated, galvanically isolated
Selectivity	Free chlorine as against combined chlorine
Disinfection process	Chlorine gas, hypochlorite, electrolysis with diaphragm, bromide + hypochlorite, DBDMH
Installation	Bypass: open sample water outlet
Sensor fitting	DGM, DLG III
Measuring and control equipment	D1C, DAC, delta® solenoid-driven metering pump
Typical applications	Cooling water, Process water, Waste water, Water with higher pH values (stable pH), contaminated swimming pool water. In swimming pools to determine the combined chlorine from the difference: Total chlorine minus free chlorine. Raw water for drinking water treatment
Resistance to	Dirt films, biofilms, surfactants
Measuring principle, technology	Amperometric, 2 electrodes, membrane-covered

	Measuring range	Order no.
CBR 1-CAN-P-10ppm		1083135



1.3 Amperometric Sensors DULCOTEST®

Sensor for free chlorine CLR 1-mA

Sensor for free chlorine above 10 ppm in contaminated washing water for use with controllers with 4-20 mA input



Your benefits

- Measured variable free chlorine for high concentrations of up to 1,000 ppm
- Diaphragm-covered sensor prevents faults caused by changing flow or ingredients in the water
- Resistance to films of dirt by pore-free diaphragm

Measured variable	free chlorine
Reference method	DPD1
pH range	5.5 ... 8.0
Temperature	5 ... 45 °C
Max. pressure	1.0 bar
Intake flow	30...60 l/h (in DGM, DLG II)
Supply voltage	16...24 V DC (2-wire)
Output signal	4...20 mA = Measuring range, temperature-compensated, uncalibrated, not electrically isolated
Selectivity	Free chlorine as against combined chlorine
Disinfection process	Chlorine gas, hypochlorite, electrolysis with diaphragm
Installation	Bypass: open sample water outlet
Sensor fitting	DLG III
Measuring and control equipment	D1Cb, DAC, delta® solenoid-driven diaphragm metering pump
Typical applications	Salad, vegetable and poultry washing water, contaminated process and waste water
Resistance to	Salts, acids, alkalis, surfactants, dirt films
Measuring principle, technology	Amperometric, 2 electrodes, membrane-covered

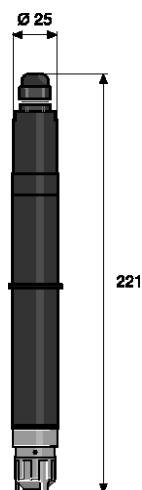

pk_6_040

	Measuring range	Order no.
CLR 1-mA-200 ppm	10.0...200 mg/l	1047978

Important note: Measuring range from 10.0 ... 1,000 mg/l on request

A mounting kit, order no. 815079, is required for initial fitting of the chlorine sensors in the in-line probe housing DLG III.



1.3 Amperometric Sensors DULCOTEST®

1.3.4 DULCOTEST® Sensors for Total Available Chlorine

Sensor for Total Available Chlorine CGE 3-mA

Sensor for total available chlorine, such as derivatives of chloro(iso)cyanuric acid trouble-free when disinfection is provided by electrolysis processes when used in swimming pools. For operation with controllers with 4-20 mA input

Your benefits

- Measured variable: total available chlorine, for instance disinfectant with organic chlorine, such as derivatives of chloro(iso)cyanuric acid
- Gold electrode to prevent faults by products from electrolysis processes where the electrodes are immersed directly into the sample water (without diaphragm)
- Diaphragm-covered sensor (encapsulated) minimises faults caused by changing flow or ingredients in the water
- Hydrophilic diaphragm guarantees the permeability of chloro(iso)cyanuric acid derivatives towards the measuring electrodes
- The special reaction system of the electrolyte allows the total available chlorine to be determined and use at a high pH of up to 9.5

Measured variable

Total available chlorine: Total of organic combined chlorine (e.g. bound to cyanuric acid) and free chlorine

Reference method

DPD1

pH range

5.5 ... 9.5

Temperature

5 ... 45 °C

Max. pressure

3.0 bar

Intake flow

30...60 l/h (in DGM or DLG III)

Supply voltage

16...24 V DC (2-wire system)

Output signal

4-20 mA ≈ Measuring range, temperature-compensated, uncalibrated, not electrically isolated

Selectivity

Total available chlorine as against combined chlorine (chloramines)

Disinfection process

Disinfectants with organic chlorine, e.g. based on cyanuric acid

Installation

Bypass: open sample water outlet

Sensor fitting

DGM, DLG III

Measuring and control equipment

D1C, DAC, delta® solenoid diaphragm metering pump

Typical applications

Swimming pool water, combined disinfection processes with chloro(iso)cyanuric acid derivatives and diaphragm-free electrolysis

Resistance to

surfactants

Measuring principle, technology

Amperometric, 2 electrodes, membrane-covered

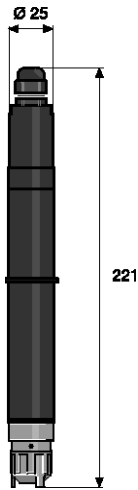

pk_6_040

	Measuring range	Order no.
CGE 3-mA-2 ppm	0.02...2.0 mg/l	1047959
CGE 3-mA-10 ppm	0.10...10.0 mg/l	1047975

A mounting kit, order no. 815079, is required for initial fitting of the chlorine sensors in the in-line probe housing DLG III.

1.3 Amperometric Sensors DULCOTEST®



Sensor for total available chlorine CGE 3-CAN-P

Sensor for total available chlorine, such as derivatives of chloro(iso)cyanuric acid when used in swimming pools. For use on controllers with CAN-bus connection

Your benefits

- Measured variable: total available chlorine, for instance disinfectant with organic chlorine, such as derivatives of chloro(iso)cyanuric acid
- Gold electrode to prevent faults by products from electrolysis processes where the electrodes are immersed directly into the sample water (without diaphragm)
- Diaphragm-covered sensor (encapsulated) minimises faults caused by changing flow or substances in the water
- Hydrophilic diaphragm guarantees the permeability of chloro(iso)cyanuric acid derivatives towards the measuring electrodes
- The special reaction system of the electrolyte allows the total available chlorine to be determined and use at a high pH of up to 9.5
- Operation on the CAN-bus with all the associated benefits

Measured variable	Total available chlorine: Total of organic combined chlorine (e.g. bound to cyanuric acid) and free chlorine
Reference method	DPD1
pH range	5.5 ... 9.5
Temperature	5 ... 45 °C
Max. pressure	3.0 bar
Intake flow	30...60 l/h (in the DGM or DLG III)
Supply voltage	Via CAN interface (11 – 30 V DC)
Output signal	Uncalibrated, temperature-compensated, electrically isolated
Selectivity	Total available chlorine as against combined chlorine (chloramines)
Disinfection process	Disinfectants with organic chlorine, e.g. based on cyanuric acid
Installation	Bypass: open sample water outlet
Sensor fitting	DGM, DLG III
Measuring and control equipment	DULCOMARIN®
Typical applications	Swimming pool water, Disinfection processes with chloro(iso)cyanuric acid derivatives
Resistance to	surfactants
Measuring principle, technology	Amperometric, 2 electrodes, membrane-covered

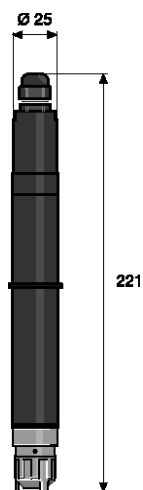

pk_6_040

	Measuring range	Order no.
CGE 3-CAN-P-10 ppm	0.01...10.0 mg/l	1083211

A mounting kit, order no. 815079, is required for initial fitting of the chlorine sensors in the in-line probe housing DLG III.



1.3 Amperometric Sensors DULCOTEST®

1.3.5 DULCOTEST® Sensors for Total Chlorine

Sensor for Total Chlorine CTE 1-mA

Sensor for total chlorine, including, for example, free chlorine, chloramines etc. even with high pH values in different kinds of water. For use on controllers with mA input

Your benefits

- Measured variable: Total chlorine, chlorine compounds, in which chlorine acts as an oxidising agent, e.g. free chlorine (HOCl and OCl⁻), chloramines etc.
- Diaphragm-covered sensor (encapsulated) prevents faults caused by changing flow or ingredients in the water
- Hydrophilic diaphragm guarantees permeability for different water-soluble oxidising agents towards the measuring electrodes
- The special reaction system of the electrolyte allows components containing oxidising chlorine to be determined and used at a high pH of up to 9.5

Measured variable	Total chlorine
Reference method	DPD4
pH range	5.5 ... 9.5
Temperature	5 ... 45 °C
Max. pressure	3.0 bar
Intake flow	30...60 l/h (in DGM or DLG III)
Supply voltage	16...24 V DC (two-wire technology)
Output signal	4...20 mA ≈ measuring range, temperature-compensated, uncalibrated, not electrically isolated
Selectivity	Non-selective, cross-sensitive towards many oxidation agents
Disinfection process	Chlorine gas, hypochlorite, electrolysis with diaphragm, monochloramine
Installation	Bypass: open sample water outlet
Sensor fitting	DGM, DLG III
Measuring and control equipment	D1C, DAC, delta® solenoid-driven diaphragm metering pump
Typical applications	CTE 1-mA-0.5 ppm: Potable water; CTE 1-mA-2/5/10 ppm: Potable, industrial, process, waste water. In swimming pools combined with CLE 3.1 to detect combined chlorine.
Resistance to	surfactants
Measuring principle, technology	Amperometric, 2 electrodes, membrane-covered

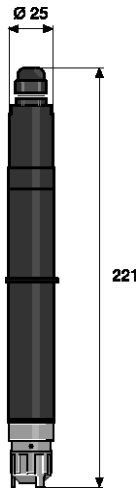

pk_6_040

	Measuring range	Order no.
CTE 1-mA-0.5 ppm	0.01...0.5 mg/l	740686
CTE 1-mA-2 ppm	0.02...2.0 mg/l	740685
CTE 1-mA-5 ppm	0.05...5.0 mg/l	1003203
CTE 1-mA-10 ppm	0.10...10.0 mg/l	740684

Chlorine sensors complete with 50 ml of electrolyte

A mounting kit, order no. 815079, is required for initial fitting of the chlorine sensors in the in-line probe housing DLG III.



1.3 Amperometric Sensors DULCOTEST®

Sensor for Total Chlorine CTE 1-DMT



Sensor for total chlorine, including, for example, free chlorine, chloramines etc. even with high pH values in different kinds of water. For operation with the transmitter DMT

Your benefits

- Measured variable: Total chlorine, chlorine compounds, in which chlorine acts as an oxidising agent, e.g. free chlorine (HOCl and OCl⁻), chloramines etc.
- Diaphragm-covered sensor (encapsulated) prevents faults caused by changing flow or ingredients in the water
- Hydrophilic diaphragm guarantees permeability for different water-soluble oxidising agents towards the measuring electrodes
- The special reaction system of the electrolyte allows components containing oxidising chlorine to be determined and used at a high pH of up to 9.5

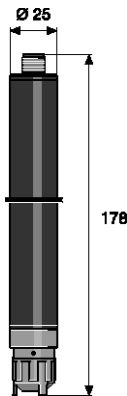

pk_6_015

Measured variable	Total chlorine
Reference method	DPD4
pH range	5.5 ... 9.5
Temperature	5 ... 45 °C
Max. pressure	3.0 bar
Intake flow	30...60 l/h (in DGM or DLG III)
Supply voltage	3.3 V DC (5 P)
Output signal	Uncalibrated, not temperature-compensated, not electrically isolated
Selectivity	Non-selective, cross-sensitive towards many oxidation agents
Disinfection process	Chlorine gas, hypochlorite, electrolysis with diaphragm, monochloramine
Installation	Bypass: open sample water outlet
Sensor fitting	DGM, DLG III
Measuring and control equipment	DMT
Typical applications	Potable, industrial, process, waste water
Resistance to	surfactants
Measuring principle, technology	Amperometric, 2 electrodes, membrane-covered

	Measuring range	Order no.
CTE 1-DMT-10 ppm	0.01...10.0 mg/l	1007540

Chlorine sensors complete with 50 ml of electrolyte

A mounting kit, order no. 815079, is required for initial fitting of the chlorine sensors in the in-line probe housing DLG III.

Signal leads see Sensor Accessories, p. → 1-119



1.3 Amperometric Sensors DULCOTEST®



Sensor for total chlorine CTE 1-CAN-P

Sensor for total chlorine, including, for example, free chlorine, chloramines etc. even with high pH values in different kinds of water. For use on controllers with CAN-bus connection

Your benefits

- Measured variable: Total chlorine, chlorine compounds, in which chlorine acts as an oxidising agent, e.g. free chlorine (HOCl and OCl⁻), chloramines etc.
- Diaphragm-covered sensor (encapsulated) prevents faults caused by changing flow or ingredients in the water
- Hydrophilic diaphragm guarantees permeability for different water-soluble oxidising agents towards the measuring electrodes
- The special reaction system of the electrolyte allows components containing oxidising chlorine to be determined and used at a high pH of up to 9.5
- Operation on the CAN-bus with all the associated benefits

Sensor for connection to a CAN interface (e.g. DULCOMARIN® 3 swimming pool controller)

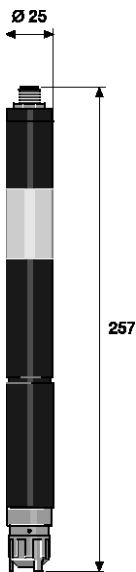

pk_6_084

Measured variable	Total chlorine
Reference method	DPD4
pH range	5.5 ... 9.5
Temperature	5 ... 45 °C
Max. pressure	3.0 bar
Intake flow	30...60 l/h (in DGMa or DLG III)
Supply voltage	Via CAN interface (11 - 30 V)
Output signal	Uncalibrated, temperature-compensated, electrically isolated
Selectivity	Non-selective, cross-sensitive towards many oxidation agents
Disinfection process	Chlorine gas, hypochlorite, electrolysis with diaphragm, monochloramine
Installation	Bypass: open sample water outlet
Sensor fitting	DGM, DLG III
Measuring and control equipment	DULCOMARIN®
Typical applications	Potable, industrial, process, waste water. In swimming pools combined with CLE 3.1 to detect combined chlorine.
Resistance to	surfactants
Measuring principle, technology	Amperometric, 2 electrodes, membrane-covered

	Measuring range	Order no.
CTE 1-CAN-P-10 ppm	0.01...10.0 mg/l	1083210

Chlorine sensors complete with 100 ml of electrolyte

A mounting kit, order no. 815079, is required for initial fitting of the chlorine sensors in the in-line probe housing DLG III.



1.3 Amperometric Sensors DULCOTEST®

1.3.6

DULCOTEST® Sensors for Bromine

Bromination agents

The following stabilised bromination agents are frequently used for disinfection during water treatment:

- BCDMH (1-**B**romo-3-**C**hloro-5,5-**D**imethyl-**H**ydantoin), marketed under trade names such as Brom-Sticks®
- DBDMH (1,3-**D**ibromo-5,5-**D**imethyl-**H**ydantoin) marketed under trade names such as Albrom 100®
- N-bromamide sulfonate

These bromination agents are initially available as solids (tablets, sticks, pellets) and are transferred via "bromine chutes" into a saturated aqueous solution, that contains the free bromine (HOBr, OBr) and the carrier molecule. The free bromine and the halogen (bromine, chlorine) still available in the carrier molecule is jointly referred to as "Total available bromine". This solution is metered during the process.

Free bromine is generated directly without a carrier by metering of sodium-calcium hypochlorite + acid + sodium bromide, e.g. the Acti-Brom® process (Nalco company) or through the metering of sodium-calcium hypochlorite into seawater (bromide containing).

Bromamines are designated as combined bromine, which are more reactive when compared with chloramines (combined chlorine).

Applications

Typical applications are in swimming pools, whirlpools, seawater and cooling circuits. Particular attention must be paid to the quality of the sample water in cooling circuits and, where necessary, compatibility with other chemicals used (e.g. corrosion inhibitors) must be checked.

The photometric DPD measurement method recommends itself as a comparison method (e.g. with DT 1B), calculated and displayed as bromine. If the photometric DPD measurement for "chlorine" is used, the measured value must be multiplied by a factor of 2.25 for conversion into "bromine".

Sensor selection

- The sensor type BCR 1 and its calibration/checking using the DPD4 method, is recommended for the measurement of stabilised bromination agents, such as BCDMH and N-bromamide sulfonate.
- The sensor type CBR 1 and its calibration/checking using the DPD1 method, is recommended for the measurement of free bromine from sodium-calcium hypochlorite and bromide or of free bromine from DBDMH (solely splits off free bromine), or of bromine compounds, which are produced during disinfection (using sodium-calcium hypochlorite or ozone) of seawater. The CBR 1 can likewise be used to measure combined bromine (bromamines), calibrated and checked using the DPD1 method.
- It is essential that the sensor type BRE 3-CAN, calibrated and checked using the DPD4 method, is used to measure bromination agents using the measuring and control system DULCOMARIN®.



1.3 Amperometric Sensors DULCOTEST®



Sensor for Total Available Bromine BCR 1-mA (Replaces Earlier Type BRE 1)

Sensor for the disinfectant BCDMH and other oxidative-acting bromine-organic disinfectants and total chlorine even in contaminated water and/or for high pH values of up to 9.5. For use on controllers with mA input

Your benefits

- Measured variable: total available bromine from BCDMH (1-bromo-3-chloro-5,5-dimethylhydantoin)
- Diaphragm-covered sensor minimises faults caused by changing flow or ingredients in the water, N-bromamide sulfonate
- Resistance to blocking is achieved by the use of an electrolyte with an antimicrobial effect (less blocking by biofilms) and by a large-pored diaphragm (less blocking by solid particles/dirt)
- Use with high pH values by optimisation of the electrolyte diaphragm system

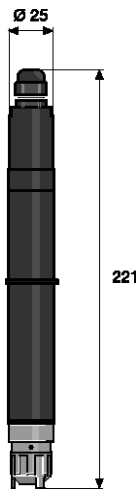

pk_6_040

Measured variable

Total available bromine from **BCDMH** (1-bromo-3-chloro-5,5-dimethylhydantoin) and **N-bromamido-sulphonate, total chlorine**

Reference method

DPD4

pH range

5.0 ... 9.5

Temperature

5 ... 45 °C

Max. pressure

1.0 bar

Intake flow

30...60 l/h (in DGM, DLG III)

Supply voltage

16...24 V DC (two wire)

Output signal

4...20 mA = Measuring range, temperature-compensated, uncalibrated, not electrically isolated

Selectivity

Non-selective, cross-sensitive towards many oxidation agents

Disinfection process

BCDMH (1-bromo-3-chloro-5,5-dimethyl-hydantoin), N-bromamide sulfonate

Installation

Bypass: open sample water outlet

Sensor fitting

DGM, DLG III

Measuring and control equipment

D1C, D2C, DAC

Typical applications

Cooling water, process water, waste water, Swimming pool water, water with higher pH values (stable pH)

Resistance to

Dirt films, biofilms, surfactants

Measuring principle, technology

Amperometric, 2 electrodes, membrane-covered

	Measuring range	Order no.
BCR 1-mA-0.5 ppm	0.01...0.5 mg/l	1041697
BCR 1-mA-2 ppm	0.02...2.0 mg/l	1040115
BCR 1-mA-10 ppm	0.10...10.0 mg/l	1041698



1.3 Amperometric Sensors DULCOTEST®



Sensor for Total Available Bromine BRE 3-CAN-P

Sensor for free and combined bromine, also for use with slightly contaminated water. For use on controllers with CAN-bus connection

Your benefits

- Measured variable: total available bromine from BCDMH and other oxidative-acting bromine organic disinfectants
- Diaphragm-covered sensor minimises faults caused by changing flow or ingredients in the water
- Use with high pH values by optimisation of the electrolyte diaphragm system
- Operation on the CAN-bus with all the associated benefits

Sensor for connection to a CAN interface (e.g. DULCOMARIN® 3 swimming pool controller)

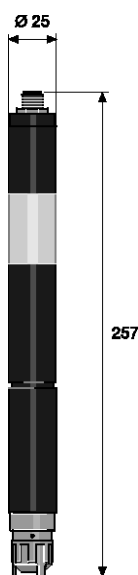

pk_6_084

Measured variable	Total available bromine
Reference method	For DBDMH, free bromine: DPD1. For BCDMH: DPD4
pH dependence	If the pH changes from pH 7 to pH 8, the sensor sensitivity is reduced a) in the case of DBDMH and free bromine by approx. 10% b) in the case of BCDMH by approx. 25%
Temperature	5 ... 45 °C
Max. pressure	3.0 bar
Intake flow	30...60 l/h (in DGM or DLG III)
Supply voltage	Via CAN interface (11 – 30 V)
Output signal	Uncalibrated, temperature-compensated, electrically isolated
Selectivity	Non-selective, cross-sensitive towards many oxidation agents
Disinfection process	DBDMH (1.3-dibromo-5,5-dimethyl-hydantoin), BCDMH (1-bromo-3-chloro-5,5-dimethyl-hydantoin), free bromine (HOBr, OBr)
Installation	Bypass: open sample water outlet
Sensor fitting	Non-selective, cross-sensitive towards many oxidation agents
Measuring and control equipment	DULCOMARIN® 3
Typical applications	swimming pools/whirlpools
Resistance to	surfactants
Measuring principle, technology	Amperometric, 2 electrodes, membrane-covered

	Measuring range	Order no.
BRE 3-CAN-10 ppm	0.02...10.0 mg/l	1083573

Note: a mounting kit (order no. 815079) is required for initial fitting of the bromine sensors in the in-line probe housing DLG III.

Signal leads see Sensor Accessories, page → 1-119



1.3 Amperometric Sensors DULCOTEST®

Sensor for Free and Combined Bromine CBR 1-mA (Replaces Earlier Type BRE 2)

Sensor for free chlorine and bromine in contaminated water, also suitable for high pH values of up to 9.5. For use with controllers with 4-20 mA input



Your benefits

- Measured variable: free chlorine as well as free and combined bromine (bromamines)
- Diaphragm-covered sensor minimises faults caused by changing flow or ingredients in the water
- Resistance to films of dirt and biofilms by electrolyte with antimicrobial effect and large-pore diaphragm
- Use at high pH value of up to 9.5 by optimisation of the electrolyte diaphragm system

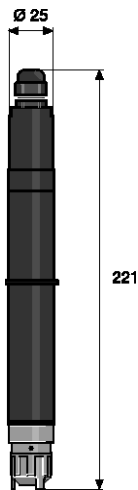

pk_6_040

Measured variable	free chlorine, free bromine, combined bromine, DBDMH (1.3-dibrom-5,5-dimethyl-hydantoin)
Reference method	DPD1
pH dependence	
Temperature	5 ... 45 °C
Max. pressure	1.0 bar
Intake flow	30...60 l/h (in DGM, DLG II)
Supply voltage	16...24 V DC (2-wire)
Output signal	4...20 mA = Measuring range, temperature-compensated, uncalibrated, not electrically isolated
Selectivity	Free chlorine as against combined chlorine
Disinfection process	Chlorine gas, hypochlorite, electrolysis with diaphragm, bromide + hypochlorite, DBDMH
Installation	Bypass: open sample water outlet
Sensor fitting	DGM, DLG III
Measuring and control equipment	D1Cb, DAC, delta® solenoid-driven diaphragm metering pump
Typical applications	Cooling water, process water, waste water, Water with higher pH values (stable pH), contaminated swimming pool water. Raw water for drinking water treatment.
Resistance to	Salts, acids, alkalis, surfactants, dirt films
Measuring principle, technology	Amperometric, 2 electrodes, membrane-covered

	Measuring range	Order no.
CBR 1-mA-0.5 ppm	0.01...0.5 mg/l...*	1038016
CBR 1-mA-2 ppm	0.02...2.0 mg/l...*	1038015
CBR 1-mA-5 ppm	0.05...5.0 mg/l...*	1052138
CBR 1-mA-10 ppm	0.10...10.0 mg/l...*	1038014

* Measuring range based on chlorine. When measuring bromine, the lower and upper limit of the measuring range are increased by the factor 2.25, therefore for example CBR 1-mA-0.5ppm: 0.02 ...1.1 ppm.



1.3 Amperometric Sensors DULCOTEST®

Sensor for free and combined bromine BRE 1-CAN-P

Sensor for free chlorine and bromine in contaminated water, also suitable for high pH values of up to 9.5. For use on controllers with CAN-bus connection.



NEW

Your benefits

- Measured variable: free chlorine as well as free and combined bromine (bromamines)
- Diaphragm-covered sensor minimises faults caused by changing flow or ingredients in the water
- Resistance to films of dirt and biofilms by electrolyte with antimicrobial effect and large-pore diaphragm
- Use at high pH value of up to 9.5 by optimisation of the electrolyte diaphragm system

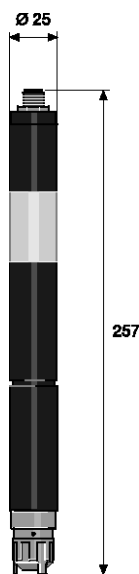

pk_6_084

Measured variable	free chlorine, free bromine, combined bromine, DBDMH (1.3-dibrom-5,5-dimethyl-hydantoin)
Reference method	DPD1
pH range	5.0 ... 9.5
Temperature	5 ... 45 °C
Max. pressure	1.0 bar
Intake flow	30...60 l/h (in DGM, DLG II)
Supply voltage	11...30 V DC (via CAN interface)
Output signal	digital (CANopen), uncalibrated, temperature-compensated, galvanically isolated
Selectivity	Free chlorine as against combined chlorine
Disinfection process	Chlorine gas, hypochlorite, electrolysis with diaphragm, bromide + hypochlorite, DBDMH
Installation	Bypass: open sample water outlet
Sensor fitting	DGM, DLG III
Measuring and control equipment	D1C, DAC, delta® solenoid-driven metering pump
Typical applications	Cooling water, Process water, Waste water, Water with higher pH values (stable pH), contaminated swimming pool water. In swimming pools to determine the combined chlorine from the difference: Total chlorine minus free chlorine. Raw water for drinking water treatment
Resistance to	Dirt films, biofilms, surfactants
Measuring principle, technology	Amperometric, 2 electrodes, membrane-covered

	Measuring range	Order no.
CBR 1-CAN-P-10ppm		1083135



1.3 Amperometric Sensors DULCOTEST®

1.3.7 DULCOTEST® Sensors for Chlorine Dioxide

Sensor type	CDE 2-mA	CDP 1-mA	CDR 1-mA
Application	Potable water	Bottle washer system	Cooling water, waste water, agriculture, hot water
Measuring range	0.01-10.0	0.02-2.00	0.01-10.0
Temperature	°C 5 ... 45	10 ... 45	1 ... 55
Temperature compensation	internal	external	internal
Max. pressure	bar 1.0	3.0	3.0
pH range	4.0 ... 11.0	5.5 ... 10.5	1.0 ... 10.0
Response time	s 120	60	180
Run-in time	h 2-6	4-12	2-6
Surfactant-resistance	no	yes	yes
Contamination resistance	no	under certain conditions	under certain conditions
Cross sensitivity	Ozone	Ozone, chlorine	Ozone

Chlorine Dioxide Sensor CDE 2-mA



Standard sensor for the measurement of chlorine dioxide without cross-sensitivity by free chlorine. For operation on controllers with 4-20 mA input

Your benefits

- Measured variable: Chlorine dioxide, no cross-sensitivity towards free chlorine
- Diaphragm-covered sensor minimises faults caused by changing flow or ingredients in the water

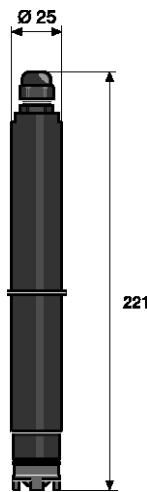

pk_6_039

Measured variable	Chlorine dioxide (ClO ₂)
Reference method	DPD1
pH range	4.0 ... 11.0 ClO ₂ stability range
Cross sensitivity	Ozone
Temperature	5 ... 45 °C
Max. pressure	1.0 bar
Intake flow	30...60 l/h (in DGM or DLG III)
Supply voltage	16...24 V DC (two-wire technology)
Output signal	4...20 mA ≈ measuring range, temperature-compensated, uncalibrated, not electrically isolated
Response time sensor t₉₀	120 s
Selectivity	Chlorine dioxide selective towards free chlorine, chlorite and chlorate
Installation	Bypass: open sample water outlet
Sensor fitting	DGM, DLG III
Measuring and control equipment	D1C, DAC
Typical applications	Untaminated drinking water (surfactant-free)
Resistance to	Salts, acids, alkalis. Not surfactants
Measuring principle, technology	Amperometric, 2 electrodes, membrane-covered

	Measuring range	Order no.
CDE 2-mA-0.5 ppm	0.01 ... 0.5 mg/l	792930
CDE 2-mA-2 ppm	0.02 ... 2.0 mg/l	792929
CDE 2-mA-10 ppm	0.10 ... 10.0 mg/l	792928

Chlorine dioxide sensors complete with 100 ml of electrolyte

Note: a mounting kit (order no. 815079) is required for initial fitting of the chlorine dioxide sensors in the in-line probe housing DLG III.



1.3 Amperometric Sensors DULCOTEST®

Chlorine Dioxide Sensor CDP 1-mA

Sensor for the measurement of chlorine dioxide with a fast response time, for example in bottle-washing systems. For operation on controllers with 4-20 mA input



Your benefits

- Measured variable: Chlorine dioxide without interference caused by surfactants
- Diaphragm-covered sensor minimises faults caused by changing flow or ingredients in the water
- Fast response time through open-pored diaphragm and external temperature measurement

Measured variable	Chlorine dioxide (ClO ₂)
Reference method	DPD1
pH range	5.5 ... 10.5
Cross sensitivity	Ozone, chlorine
Temperature	10 ... 45 °C
Max. pressure	3.0 bar
Intake flow	30...60 l/h
Supply voltage	16...24 V DC (two-wire technology)
Output signal	4...20 mA ≈ measuring range, not temperature-compensated, uncalibrated, not electrically isolated
Temperature measurement	Separate temperature measurement needed for compensation
Response time sensor t₉₀	60 s
Selectivity	Chlorite, Chlorate, Free chlorine
Installation	Bypass: open sample water outlet
Sensor fitting	ProMinent recommends installing the sensor in the DLG II in-line probe fitting with upstream flow monitoring together with a Pt 100 temperature sensor
Measuring and control equipment	D1C and DACa with automatic temperature correction only
Typical applications	Process water containing surfactants (bottle washing machines)
Resistance to	Surfactants, slight films of dirt
Measuring principle, technology	Amperometric, 2 electrodes, membrane-covered

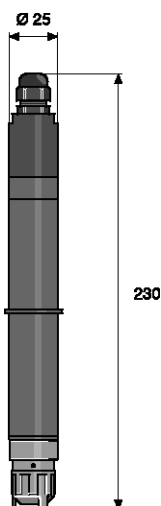

pk_6_047

	Measuring range	Order no.
CDP 1-mA-2 ppm	0.02...2.0 mg/l	1002149

Chlorine dioxide sensors complete with 100 ml of electrolyte

Note: a mounting kit (order no. 815079) is required for initial fitting of the chlorine dioxide sensors in the in-line probe housing DLG III.



1.3 Amperometric Sensors DULCOTEST®



Chlorine Dioxide Sensor CDR 1-mA

Sensor for the measurement of chlorine dioxide for all kinds of water, including hot and contaminated water. Without cross-sensitivity by free chlorine. For operation on controllers with 4-20 mA input

Your benefits

- Measured variable: Chlorine dioxide, without cross-sensitivity towards free chlorine
- Diaphragm-covered sensor minimises faults caused by changing flow or ingredients in the water
- Resistance to films of dirt by pore-free diaphragm
- Operating temperature up to 60 °C (short term) by appropriate sensor materials

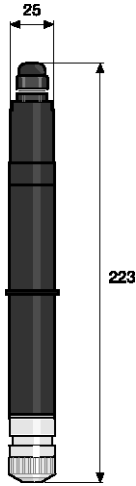

pk_6_083

Measured variable	Chlorine dioxide (ClO ₂)
Reference method	DPD1
pH range	1.0 ... 10.0
Cross sensitivity	Ozone
Temperature	1 ... 55 °C (short-term period 60 °C)
Max. pressure	3.0 bar, (30°C, in the DGMa)
Intake flow	30...60 l/h (in DGM or DLG III)
Supply voltage	16...24 V DC
Output signal	4...20 mA Temperature-compensated, uncalibrated, not electrically isolated
Response time sensor t₉₀	3 min.
Selectivity	Chlorite
Installation	Bypass: open sample water outlet
Sensor fitting	DGMa/DLGIII
Measuring and control equipment	D1C, DAC
Typical applications	Contaminated industrial, process water, containing surfactants, cooling water, irrigation water, slightly contaminated waste water, warm water
Resistance to	Surfactants, slight films of dirt, water-soluble chemicals, solids/dirt, biofilms
Measuring principle, technology	Amperometric, 2 electrodes, membrane-covered

	Measuring range	Order no.
CDR 1-mA-0.5 ppm	0.01...0.5 mg/l	1033762
CDR 1-mA-2 ppm	0.02...2.0 mg/l	1033393
CDR 1-mA-10 ppm	0.10...10.0 mg/l	1033404

Note: a mounting kit (order no. 815079) is required for initial fitting of the chlorine dioxide sensors in the in-line probe housing DLG III.



1.3 Amperometric Sensors DULCOTEST®



Chlorine Dioxide Sensor CDR 1-CAN

Sensor for the measurement of chlorine dioxide for all kinds of water, including hot and contaminated water. Without cross-sensitivity by free chlorine. For operation on controllers with 4-20 mA input

Your benefits

- Measured variable: Chlorine dioxide, without cross sensitivity to free chlorine
- Diaphragm-covered sensor minimises faults caused by changing flow or ingredients in the water
- Resistance to films of dirt by pore-free diaphragm
- Operating temperature up to 60 °C (short term) by appropriate sensor materials
- Operation on the CAN-bus with all the associated benefits

Sensors for connection to a CAN interface (e.g. Disinfection Controller)

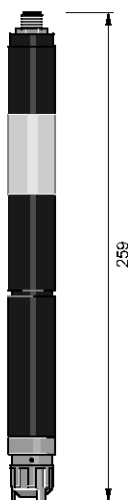

P_DT_0071_SW1

Measured variable	Chlorine dioxide (ClO ₂)
Reference method	DPD1
pH range	1.0 ... 10.0
Cross sensitivity	Ozone
Temperature	5 ... 45 °C
Max. pressure	1.0 bar
Intake flow	30...60 l/h (in DGM or DLG III)
Supply voltage	Via CAN interface (11-30 V)
Output signal	Uncalibrated, temperature-compensated, electrically isolated
Response time sensor t₉₀	3 min.
Selectivity	Chlorite, Chlorate, Free chlorine
Installation	Bypass: open sample water outlet
Sensor fitting	DGMa/DLGIII
Measuring and control equipment	DULCOMARIN® 3
Typical applications	Contaminated industrial, process water, containing surfactants, cooling water, irrigation water, slightly contaminated waste water
Resistance to	Surfactants, water-soluble pollutants, solids/dirt, biofilms
Measuring principle, technology	Amperometric, 2 electrodes, membrane-covered

	Measuring range	Order no.
CDR 1-CAN-10 ppm	0.01...10.0 mg/l	1041155

* Complete with 100 ml of electrolyte, connecting cable - CAN M12 5-pin 0.5 m, T-distributor M12 5-pin CAN



1.3 Amperometric Sensors DULCOTEST®

1.3.8 DULCOTEST® Sensors for Chlorite

Chlorite Sensor, CLT 1-mA

Sensor for monitoring the disinfection by-product chlorite in compliance with potable water regulations. Without cross-sensitivity towards chlorine dioxide, chlorate and chlorine. For operation on controllers with 4-20 mA input

Your benefits

- Online monitoring of the disinfection by-product chlorite
- Diaphragm-covered sensor minimises faults caused by changing flow or ingredients in the water
- No interference by chlorine dioxide/chlorine/chlorate
- Online monitoring improves process reliability
- Online monitoring replaces expensive laboratory analysis

Measured variable

Chlorite anion (ClO_2^-)

Reference method

DPD method, chlorite in the presence of chlorine dioxide

pH range

6.5 ... 9.5

Cross sensitivity

reducing chemicals, e. g. Fe^{2+} , Mn^{2+}

Temperature

1 ... 40 °C

Max. pressure

1.0 bar

Intake flow

30...60 l/h (in DGM or DLG III)

Supply voltage

16...24 V DC (two-wire technology)

Output signal

4...20 mA \approx measuring range, temperature-compensated, uncalibrated, not electrically isolated

Selectivity

Chlorite selective towards chlorine dioxide, chlorate and free chlorine

Installation

Bypass: open sample water outlet

Sensor fitting

DGM, DLG III

Measuring and control equipment

D1C, DAC

Typical applications

Monitoring of chlorine dioxide treated potable water or similar water. The selective measurement of chlorite alongside chlorine dioxide, chlorine and chlorate is possible.

Resistance to

surfactants

Measuring principle, technology

Amperometric, 2 electrodes, membrane-covered

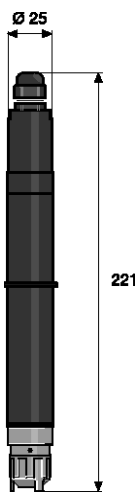

pk_6_040

DVGW recommended

	Measuring range	Order no.
CLT 1-mA-0.5 ppm	0.02...0.5 mg/l	1021596
CLT 1-mA-2 ppm	0.10...2.0 mg/l	1021595

Chlorite sensors complete with 50 ml of electrolyte.

Note: A mounting kit (order no. 815079) is required for initial fitting of the chlorite sensors in the in-line probe housing DLG III.

The DT4 photometer is recommended for calibration of the chlorite sensor.

1.3 Amperometric Sensors DULCOTEST®



Chlorite Sensor CLT 1-CAN

Sensor for monitoring the disinfection by-product chlorite in compliance with potable water regulations. Without cross-sensitivity towards chlorine dioxide, chlorate and chlorine. For use on controllers with CAN-bus connection

Your benefits

- Online monitoring of the disinfection by-product chlorite
- Diaphragm-covered sensor minimises faults caused by changing flow or ingredients in the water
- No interference by chlorine dioxide/chlorine/chlorate
- Online monitoring improves process reliability
- Online monitoring replaces expensive laboratory analysis
- Operation on the CAN-bus with all the associated benefits

Sensors for connection to a CAN interface (e.g. Disinfection Controller)

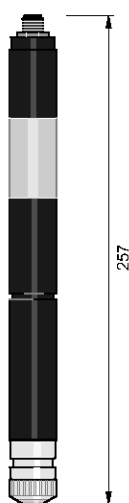

P_DT_0070_SW1

Measured variable	Chlorite anion (ClO ₂ ⁻)
Reference method	DPD method, chlorite together with chlorine dioxide
pH range	6.5 ... 9.5
Cross sensitivity	reducing chemicals, e. g. Fe ²⁺ , Mn ²⁺
Temperature	1 ... 40 °C
Max. pressure	1.0 bar
Intake flow	30...60 l/h (in DGM or DLG III)
Supply voltage	Via CAN interface (11-30 V)
Output signal	Uncalibrated, temperature-compensated, electrically isolated
Response time sensor t₉₀	3 min.
Selectivity	Chlorite selective towards chlorine dioxide, chlorate and free chlorine
Installation	Bypass: open sample water outlet
Parts number/Identity code	DGM, DLG III
Measuring and control equipment	DULCOMARIN® 3
Typical applications	Monitoring of potable water or similar water treated with chlorine dioxide. Selective measurement of chlorite and chlorine dioxide, chlorine and chlorate is also possible.
Resistance to	surfactants
Measuring principle, technology	Amperometric, 2 electrodes, membrane-covered

	Measuring range	Order no.
CLT 1-CAN-2 ppm	0.05...2.0 mg/l	1041156

* Complete with 100 ml of electrolyte, connecting cable - CAN M12 5-pin 0.5 m, T-distributor M12 5-pin CAN



1.3 Amperometric Sensors DULCOTEST®

1.3.9 DULCOTEST® Sensors for Ozone

Ozone sensor OZE 3-mA

Standard sensor for measuring ozone in clear water. For operation on controllers with 4-20 mA input

Your benefits

- Measured variable: Ozone, without cross sensitivity to chlorine, hydrogen peroxide
- Diaphragm-covered sensor (encapsulated) minimises faults caused by changing flow or ingredients in the water

Measured variable	Ozone (O ₃)
Reference method	DPD4
pH range	4.0 ... 11.0 Ozone stability range
Cross sensitivity	Chlorine dioxide
Temperature	5 ... 40 °C
Max. pressure	1.0 bar
Intake flow	30...60 l/h (in DGM or DLG III)
Supply voltage	16...24 V DC (two-wire technology)
Output signal	4...20 mA ≈ measuring range, temperature-compensated, uncalibrated, not electrically isolated
Selectivity	Ozone as against free chlorine, combined chlorine, hydrogen peroxide
Installation	Bypass: open sample water outlet
Sensor fitting	DGM, DLG III
Measuring and control equipment	D1C, DAC
Typical applications	Potable water and swimming pool water
Resistance to	Salts, acids, alkalis. Not surfactants
Measuring principle, technology	Amperometric, 2 electrodes, membrane-covered

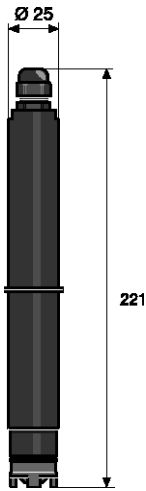

pk_6_039

	Measuring range	Order no.
OZE 3-mA-2 ppm	0.02...2.0 mg/l	792957

Ozone sensor complete with 100 ml of electrolyte.

Note: A mounting kit (order no. 815079) is required for initial fitting of the ozone sensors in the in-line probe housing DLG III.



1.3 Amperometric Sensors DULCOTEST®

Ozone sensor OZR 1-mA



Sensor for measuring and monitoring the absence of ozone, also suitable for use in contaminated water. For operation on controllers with 4-20 mA input

Your benefits

- Measured variable: Ozone, without cross sensitivity to chlorine, hydrogen peroxide
- Diaphragm-covered sensor (encapsulated) minimises faults caused by changing flow or ingredients in the water
- Suitable also for monitoring the absence of ozone (rupture monitoring on filters) and for discontinuous ozone treatment processes
- Resistance to films of dirt by pore-free diaphragm

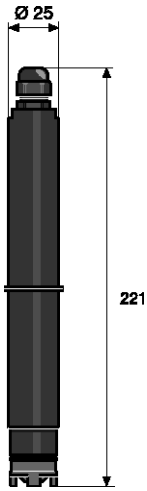

pk_6_039

Measured variable	Ozone (O ₃)
Reference method	DPD4
pH range	4.0 ... 11.0 Stability range of ozone
Cross sensitivity	chlorine dioxide, peracetic acid, bromine, bromamine
Temperature	5 ... 40 °C
Max. pressure	1.0 bar
Intake flow	30...60 l/h (in the DGM or DLG III)
Supply voltage	16...24 V DC (two-wire system)
Output signal	4...20 mA ≈ Measuring range, temperature-compensated, uncalibrated, not electrically isolated
Response time t₉₀ after 1 month with 0 ppm ozone	<210s
Selectivity	Non-selective
Installation	Bypass: open sample water outlet
Sensor fitting	DGM, DLG III
Measuring and control equipment	D1C, DAC
Typical applications	Potable water, swimming pool water, Process, service or cooling water, monitoring the ozone breakdown of filters
Resistance to	Salts, acids, alkalis, surfactants, dirt films
Measuring principle, technology	Amperometric, 2 electrodes, membrane-covered

	Measuring range	Order no.
OZR 1-mA-2 ppm	0.02...2.0 mg/l	1051647

Important note: A mounting kit (order no. 815079) is required for initial fitting of the ozone sensors in the in-line probe housing DLG III.



1.3 Amperometric Sensors DULCOTEST®

1.3.10 DULCOTEST® Sensors for Dissolved Oxygen

The measured variable "Dissolved oxygen" indicates the volume of gaseous oxygen physically dissolved in the aqueous phase in mg/l (ppm).

"Dissolved oxygen" is therefore an important parameter for assessing the quality of surface water and water that has to be treated for the breeding of livestock with the addition of oxygen. Dissolved oxygen is also used for controlling processes in clarification plants and waterworks.

The following sensors are assigned to the different applications and can be offered separately as 4 - 20 mA encoders to central controls or as a decentralised solution along with D1C and DAC (measured variable: "Dissolved oxygen": X).

Oxygen Sensor DO 1-mA

Sensor for the measurement of the dissolved oxygen above 2 ppm to oxygen saturation. For installation in standard immersion pipes or in the bypass line. Use in waterworks, in fish breeding or to monitor surface water

Your benefits

- Measured variable: dissolved oxygen, no interference by turbidity or discolouration by the amperometric measuring principle
- Rod-shaped construction for simple installation into standard immersion pipes and bypass lines
- Diaphragm-covered sensor minimises faults caused by changing flow or ingredients in the water
- Minimal maintenance and long service life due to encapsulated transducer (easily replaceable thanks to bayonet fitting)
- Measuring electrodes protected by pore-free, dirt-repellent diaphragm
- Long service life of the electrolyte at high oxygen concentrations through optimised membrane thickness
- Stable zero point by means of large diaphragm-covered electrodes

Measured variable	Dissolved oxygen
Calibration	Of oxygen in air
Measuring accuracy	±0.5% relative to final value of measuring range
Response time sensor t₉₀	110 s
Temperature	0 ... 50 °C
Max. pressure	1.0 bar
Intake flow	Minimum: 0.05 m/s
Supply voltage	12...30 V DC
Electrical connection	Fixed lead, 10 m
Output signal	4...20 mA ≈ measuring range, calibrated, temperature-compensated and electrically isolated

Enclosure rating	IP 68
Measuring and control equipment	D1Cb, DAC
Process integration	a) Immersion, suspended on cable with or without cable bracket (see accessories) b) Immersion with immersion pipe 1. Immersion pipe with 50 mm outside diameter and 1-1/4 inch internal thread (provided by the customer). The connection is possible via an immersion pipe adapter (see accessories). 2. PVC immersion pipe with 50 mm outside diameter (provided by the customer). The connection is made by adhesion via a standard PVC union (provided by the customer). c) In-flow operation on request
Measuring and control equipment	D1Cb, DAC

Typical applications	Fish and shrimp farming, conditioning of water in large aquaria in zoological parks, control of the oxygen input in waterworks, appraisal of the biological status of surface waters.
Resistance to	Ingredients in the water, dirt films
Measuring principle, technology	Amperometric, 2 electrodes, membrane-covered, encapsulated transducer

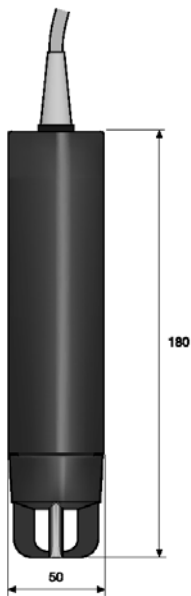

pk_6_050_1

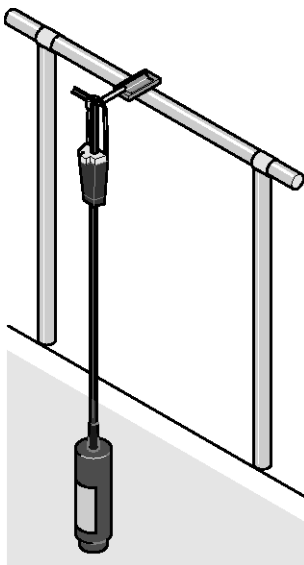

pk_6_011

	Measuring range	Order no.
DO 1-mA-20 ppm	2.00...20.0 mg/l	1020532

Note: Will be replaced like for like from 2nd quarter of 2018.

1.3 Amperometric Sensors DULCOTEST®

Oxygen Sensor DO 2-mA

Sensor for the measurement of the dissolved oxygen, specifically optimised for control above 0.1 ppm in the aeration tanks of clarification plants. Integrated in a floating ball with a cleaning function

Your benefits

- Measured variable: dissolved oxygen, no interference by turbidity or discolouration by the amperometric measuring principle
- Integration of the encapsulated transducer in a specially-shaped floating ball., creating a Venturi flow, which helps to clean the sensor membrane
- Diaphragm-covered sensor minimises faults caused by changing flow or ingredients in the water
- Minimal maintenance and long service life due to encapsulated transducer (easily replaceable thanks to bayonet fitting)
- Measuring electrodes protected by pore-free, dirt-repellent diaphragm
- Long service life of the electrolyte at low to medium oxygen concentrations, as occur in the aeration tanks of clarification plants, by means of optimised membrane thickness
- Stable zero point by means of large diaphragm-covered electrodes

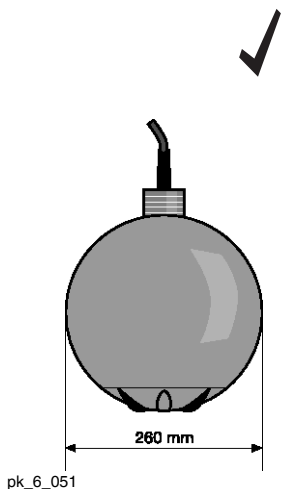

Measured variable	Dissolved oxygen
Calibration	Of oxygen in air
Measuring accuracy	±0.5% relative to final value of measuring range
Response time sensor t_{90}	22 s
Temperature	0 ... 50 °C
Max. pressure	1.0 bar
Intake flow	Minimum: 0.05 m/s
Supply voltage	12...30 V DC
Electrical connection	Fixed lead, 10 m
Output signal	4...20 mA measuring range calibrated, temperature-corrected and electrically isolated
Enclosure rating	IP 68
Measuring and control equipment	D1Cb, DAC
Process integration	As a float with venturi grooves to increase the flow of sample water for the self-cleaning of the sensor part. Supplied with adapter for connection to PVC pipes with outside diameter: 50 mm and railing bracket, also for PVC pipes with outside diameter: 50 mm (see accessories). The customer must provide the straight PVC tube and a 45 ° standard elbow for gluing to PVC pipes (outside diameter 50 mm).
Measuring and control equipment	D1Cb, DAC
Typical applications	Control of the oxygen input in activated sludge pools (sewage plant) for the purpose of energy conservation.
Resistance to	Ingredients in the water, dirt films
Measuring principle, technology	Amperometric, 2 electrodes, membrane-covered, encapsulated transducer integrated in ball float

For further information: Installation Fittings / Adapters see page → 1-132

	Measuring range	Order no.
DO 2-mA-10 ppm	0.10...10.0 mg/l	1020533

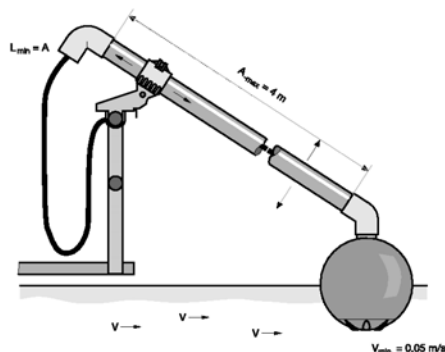

pk_6_012

Note: Will be replaced like for like from 2nd quarter of 2018.



1.3 Amperometric Sensors DULCOTEST®

1.3.11 DULCOTEST® Sensors for Peracetic Acid

DULCOTEST® sensors of type PAA 1 are diaphragm-covered, amperometric 2-electrode sensors for the selective measurement of peracetic acid. Peracetic acid is particularly used in the food and beverage industry, but also for disinfection in the cosmetics, pharmaceutical and medical sectors. The continuous measurement and control of peracetic acid is therefore required when there are high demands in terms of disinfection and quality assurance. Commissioning and maintenance are significantly simplified. The sensor can also be used where there are surfactants.

Peracetic Acid Sensor PAA 1-mA



Sensor for the measurement of peracetic acid without cross-sensitivity towards hydrogen peroxide. For use in contaminated washing and waste water

Your benefits

- Measured variable: Peracetic acid, without cross-sensitivity towards the accompanying chemical, hydrogen peroxide
- Diaphragm-covered sensor minimises faults caused by changing flow or ingredients in the water
- Resistance to films of dirt by pore-free diaphragm

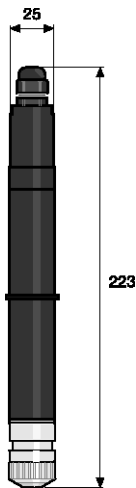

pk_6_083

Measured variable	Peracetic acid
Reference method	Titration
pH range	1.0 ... 9.0 (peracetic acid stability range)
Cross sensitivity	Ozone, chlorine dioxide, chlorine, bromine
Temperature	1 ... 45 °C
Admissible temperature fluctuation	0.3 °C/min
Response time sensor t₉₀	≈ 3 min
Max. pressure	3.0 bar, (30 °C, in DGM)
Intake flow	30...60 l/h (in in-line probe housing DGM or DLG III)
Supply voltage	16...24 V DC (two-wire technology)
Output signal	4...20 mA ≈ measuring range, temperature-compensated, uncalibrated, not electrically isolated
Selectivity	Peracetic acid selective towards hydrogen peroxide
Installation	Bypass: open sample water outlet
In-line probe fitting	DGM, DLG
Measuring and control equipment	D1C, DAC
Typical applications	Scouring in Cleaning in Place (CIP), rinsers, also suitable in the presence of cationic and anionic tensides. The selective measurement of peracetic acid and hydrogen peroxide is possible.
Resistance to	Salts, acids, alkalis, surfactants, dirt films
Measuring principle, technology	Amperometric, 2 electrodes, membrane-covered

	Measuring range	Order no.
PAA 1-mA-200 ppm	1...200 mg/l	1022506
PAA 1-mA-2000 ppm	10...2,000 mg/l	1022507

Note: a mounting kit (order no. 815079) is required for initial fitting of the sensors in the in-line probe housing DLG III.



1.3 Amperometric Sensors DULCOTEST®

1.3.12 DULCOTEST® Sensors for Hydrogen Peroxide

DULCOTEST® sensors PEROX and PER1 are membrane-covered, amperometric sensors for the online concentration measurement of hydrogen peroxide. Due to its complete biodegradability, hydrogen peroxide is a disinfectant and oxidising agent frequently used in water treatment and production:

- chemical bleach in the wood, paper, textile and mineral compounds industries,
- organic synthesis in the chemical, pharmaceutical and cosmetics industries,
- oxidation of potable water, landfill seepage water, contaminated ground water,
- disinfection of cooling, process and production water in the pharmaceutical, food and beverage industries as well as in swimming pools,
- deodorisation (gas scrubbers) in municipal and industrial clarification plants,
- dechlorination in chemical processes.

Sensors are selected according to the following decision-making table:

Requirement	Type PER1	PEROX
Sample matrix loaded with dirt and chemicals	Suitable due to water-impermeable diaphragm, however sensitive to the presence of hydrogen sulphide (H ₂ S), oxidant	Failure-prone due to water-permeable diaphragm
Electrical influence due to interference potential in the measurement medium	Insensitive because the counter electrode is separated from the process	More sensitive because counter electrode is in the medium
Temperature range	Up to 50 °C	Up to 40 °C
Simple handling during installation and maintenance	Suitable due to temperature compensation and transmitters integrated in the sensor	Separate temperature sensor and transmitter
Response time as t₉₀	480 s	20 s
Quick temperature changes	Slow due to integrated temperature sensor	Fast due to separate temperature sensor
Measuring intervals in the absence of H₂O₂	Unsuitable	Suitable due to pulsed polarisation technology
Measuring range can vary in phased approach due to orders of magnitude or is not clear in the order	Selection of a suitable sensor is necessary	Suitable because the measuring range can be manually switched on the sensor transducer



1.3 Amperometric Sensors DULCOTEST®



Hydrogen Peroxide Sensor PER1

Sensor for the measurement of hydrogen peroxide even in chemically contaminated and polluted water. Available with measuring ranges for extremely low or very high concentrations

Your benefits

- Measured variable hydrogen peroxide, with measuring ranges from 0.5 ppm to 100,000 ppm (10% available)
- Diaphragm-covered sensor minimises faults caused by changing flow or ingredients in the water
- Resistance to films of dirt by pore-free diaphragm
- Operating temperature up to 50 °C

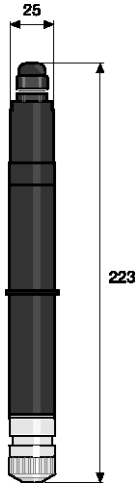

pk_6_083

Measured variable	Hydrogen peroxide
Calibration	Photometric with manual DT3B photometer
pH range	1.0 ... 11.0
Cross sensitivity	Ozone, chlorine dioxide, peracetic acid, chlorine, bromine
Temperature	0 ... 50 °C
Admissible temperature fluctuation	< 0.3 °C/min
Response time sensor t₉₀	approx. 480 sec
Min. conductivity	0.05 ... 5.00 mS/cm
Max. pressure	1.0 bar
Intake flow	20...100 l/h
Supply voltage	16...24 V DC (two-wire system)
Output signal	4...20 mA temperature-compensated, uncalibrated, not electrically isolated
Selectivity	Hydrogen peroxide selective towards sulphite
Installation	Bypass: open outlet or return of the sample water into the process line
In-line probe fitting	DGM, DLG
Measuring and control equipment	D1Cb, DAC
Typical applications	Swimming pools, treatment of contaminated waste waters, treatment of process media from production
Resistance to	Salts, acids, alkalis, surfactants, dirt films, not against hydrogen sulphide (H ₂ S)
Measuring principle, technology	Amperometric, 2 electrodes, membrane-covered

	Measuring range	Order no.
PER 1-mA-50 ppm	0.50...50.0 mg/l	1030511
PER 1-mA-200 ppm	2.00...200.0 mg/l	1022509
PER 1-mA-2000 ppm	20.00...2,000.0 mg/l	1022510

Important note: Measuring ranges up to 100,000 ppm on request
Photometer→ 2-94

Accessories

	Order no.
Photometer DT3B hydrogen peroxide (for calibration)	1039317

Note: a mounting kit (order no. 815079) is required for initial fitting of the sensors in the in-line probe housing DLG III.



1.3 Amperometric Sensors DULCOTEST®



Hydrogen Peroxide Sensor PEROX

Sensor for the measurement of hydrogen peroxide without cross-sensitivity to chlorine. Can also be used for fast control processes in clear water

Your benefits

- Measured variable hydrogen peroxide without cross sensitivity to chlorine
- Diaphragm-covered sensor minimises faults caused by changing flow
- Control of fast processes through rapid response time by the sensor in conjunction with fast external temperature measurement for temperature correction
- Reliable measurement even after periods of absence of hydrogen peroxide by pulsed, self-regenerating measuring electrode

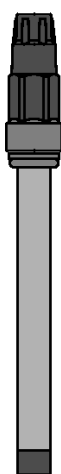

P_DT_0075_SW

Measured variable	Hydrogen peroxide
Calibration	Photometric with manual DT3B photometer
Measuring range	1... 20/10 ... 200/100 ... 2000 mg/l switchable
pH range	2.5 ... 10.0
Temperature	0 ... 40 °C
Admissible temperature fluctuation	< 1 °K/min (for external temp. measurement) see operating instructions
Response time sensor t₉₀	approx. 20 sec
Min. conductivity	With 20 mg/l range: 5 µS/cm With 200 mg/l range: 200 µS/cm Up to 1,000 mg/l: 500 µS/cm Up to 2,000 mg/l: 1 mS/cm
Max. pressure	2.0 bar
Intake flow	30...60 l/h
Supply voltage	16...24 V DC (3-wire system)
Output signal	4...20 mA not temperature-compensated, uncalibrated, not electrically isolated
Selectivity	Hydrogen peroxide selective towards free chlorine
Installation	Bypass: open outlet or return of the sample water into the process line
In-line probe fitting	DGM, DLG
Measuring and control equipment	DAC
Typical applications	Treatment of clear and chemically uncontaminated waters, control with necessary short response times
Resistance to	Salts, acids, alkalis, surfactants, dirt films
Measuring principle, technology	amperometric, 2 pulsing electrodes, diaphragm-covered

	Order no.
PEROX sensor PEROX-H2.10 P	792976
PEROX transducer V1 for D1Ca	1034100
PEROX transducer V2 for DACa and DACb	1047979

Photometer → 2-94

Accessories

	Order no.
Photometer DT3B hydrogen peroxide (for calibration)	1039317



1.4 DULCOTEST® Conductivity Sensors

Overview Table for Conductivity Sensors

Type	Measuring range mS/cm	Cell constant k cm ⁻¹	Medium temperature max. °C	Max. pressure bar	Shaft material	Temperature compensation	Process integration	Electrical connection on the measuring device
LMP001 → 1-91	0.01...50 mS/cm	0.01 ±5 %	70	16	PP	Pt 100	Flow, 3/4" outer thread	DIN 4-pin angle plug, on Compact; DMTa
LMP 001-HT → 1-92	0.01...50 mS/cm	0.01 ±5 %	120	16	PVDF	Pt 100	Flow, 3/4" outer thread	DIN 4-pin angle plug, on Compact; DMTa
LMP 01 → 1-93	0.1...500 mS/cm	0.1 ±5 %	70	16	PP	Pt 100	Flow, 3/4" outer thread	DIN 4-pin angle plug, on Compact; DMTa
LMP 01-HT → 1-95	0.1...500 mS/cm	0.1 ±5 %	120	16	PVDF	Pt 100	Flow, 3/4" outer thread	DIN 4-pin angle plug, on Compact; DMTa
LMP 01-TA → 1-94	0.1...500 mS/cm	0.1 ±5 %	70	16	PP	Pt 100	Immersion, including immersion fitting 1 m	5 m fixed cable, on Compact; DMTa
LFT 1 FE → 1-96	0.01...20 mS/cm	1 ±5 %	80	16	Epoxy	Pt 100	PG 13.5, flow (length: 120 mm) or immersion	5 m fixed cable (4 x 0.5 mm ²), on DMTa
LFTK 1 FE-5m-shd → 1-97	0.01...20 mS/cm	1 ±5 %	80	16	Epoxy	Pt 1000	PG 13.5, flow (length: 120 mm) or immersion	5 m fixed cable (4 x 0.25 mm ²), screened, on Compact; DMTa
LFTK 1 FE-3m-shd → 1-98	0.01...20 mS/cm	1 ±5 %	80	16	Epoxy	Pt 1000	PG 13.5, flow (length: 120 mm) or immersion	3 m fixed cable (4 x 0.25 mm ²), screened, on Compact; DMTa
LF 1 DE → 1-99	0.01...20 mS/cm	1 ±5 %	80	16	Epoxy	None, only for applications with constant temperature	PG 13.5, flow (length: 120 mm) or immersion	DIN 4-pin angle plug, on Compact; DMTa
LFT 1 DE → 1-100	0.01...20 mS/cm	1 ±5 %	80	16	Epoxy	Pt 100	PG 13.5, flow (length: 120 mm) or immersion	DIN 4-pin angle plug, on Compact; DMTa
LFTK 1 DE → 1-101	0.01...20 mS/cm	1 ±5 %	80	16	Epoxy	Pt 1000	PG 13.5, flow (length: 120 mm) or immersion	DIN 4-pin angle plug, on Compact; DMTa
LFT 1 1/2" → 1-102	0.01...20 mS/cm	1 ±5 %	80	16	Epoxy	Pt 100	1/2 inch male thread, flow (length: 120 mm) or immersion	DIN 4-pin angle plug, on Compact; DMTa
LFTK 1 1/2" → 1-103	0.01...20 mS/cm	1 ±5 %	80	16	Epoxy	Pt 1000	1/2 inch male thread, flow (length: 120 mm) or immersion	DIN 4-pin angle plug, on Compact; DMTa
CK 1 → 1-104	0.01...20 mS/cm	1 ±5 %	150	16	PES	none, only for applications with constant temperature	Flow, 1" outer thread	DIN 4-pin angle plug, on Compact; DMTa
CKPt 1 → 1-105	0.01...20 mS/cm	1 ±5 %	150	16	PES	Pt 100	Flow, 1" outer thread	DIN 4-pin angle plug, on Compact; DMTa
LM 1 → 1-106	0.1...20 mS/cm	1 ±5 %	70	16	PP	-	Flow, 3/4" outer thread	DIN 4-pin angle plug, on Compact; DMTa
LM 1-TA → 1-107	0.1...20 mS/cm	1 ±5 %	70	16	PP	-	Immersion, including immersion fitting 1 m	5 m fixed cable, screened, on Compact; DMTa



1.4 DULCOTEST® Conductivity Sensors

Type	Measuring range mS/cm	Cell constant k cm ⁻¹	Medium temperature max. °C	Max. pressure bar	Shaft material	Temperature compensation	Process integration	Electrical connection on the measuring device
LMP 1 → 1-108	0.1...20 mS/cm	1 ±5 %	70	16	PP	Pt 100	Flow, 3/4" outer thread	DIN 4-pin angle plug, on Compact; DMTa
LMP 1-HT → 1-110	0.1...20 mS/cm	1 ±5 %	120	16	PVDF	Pt 100	Flow, 3/4" outer thread	DIN 4-pin angle plug, on Compact; DMTa
LMP 1-TA → 1-109	0.1...20 mS/cm	1 ±5 %	70	16	PP	Pt 100	Immersion, including immersion fitting 1 m	5 m fixed cable, screened, on Compact; DMTa
CCT 1-mA → 1-111	0.02...20 mS/cm		50	8	PVC	NTC	Bypass (DGM, DLGIII fitting), flow (INLI fitting)	4-wire cable/ 0.25 mm ² / cable diameter 5.7 mm, über Klemme
LF 204 → 1-112	0.1...500 mS/cm	0.48 ±1.5 %	–	2	–	–	Manual immersion	3 m fixed cable, extendible to 50 m, with cable type: 0.5 mm ² or AWG 22.,
ICT 1 → 1-112	0.2...1,000 mS/cm	8.5 ±5 %	70	16	PP	Pt 100	Flow DN 50	On Portames 911 Cond
ICT 1-IMA → 1-113	0.2...1,000 mS/cm	8.5 ±5 %	70	8	PP	Pt 100	Immersion including immersion fitting 1 m	7 m fixed cable, On Compact
ICT 5 → 1-114	0.2...2,000 mS/cm	6.25 ±5 %	80	10	PP	Pt 100	Flow DN 40	7 m fixed cable, On Compact
ICT 5-IMA → 1-115	0.2...2,000 mS/cm	6.25 ±5 %	60	0	PP	Pt 100	Immersion, sensor integrated in 1 m immersion fitting	7 m fixed cable,
ICT 2 → 1-116	0.02...2,000 mS/cm	1.98	125	16	PFA	Pt 100, class A, completely extrusion-coated	Installation with SS flange, immersion with immersion pipe fixed cable (Accessories)	7 m fixed cable,

General information:

- 1 The DMTa transducer is available for conversion of the measurement signal into a temperature compensated 4-20 mA signal (see Chapter 8).
- 2 Connections for the DIN-4 pole angle plug:
 - Sensors: Earth and 2
 - Pt 100/1000: 1 and 3
- 3 With DIN 4 pole angle plugs, the cable must be screened if the sensor is connected to the compact controller or DMTa.
- 4 An adapter set PG 13.5 / 1" (order no. 1002190) is necessary for installation in the in-line probe housing type DLG III (1"-hole).

Measuring line for conductive conductivity sensors see page → 1-120



1.4 DULCOTEST® Conductivity Sensors

1.4.2 2-Electrode Conductivity Sensors

Conductive conductivity sensors measure the electrolytic conductivity indirectly via the charge transfer between two electrodes immersed in the medium to be measured. The sensor types with cell constants $k = 0.01$ and $k = 0.1 \text{ cm}^{-1}$ are especially suitable for the measurement of the lowest electrolytic conductivities of $< 1 \text{ }\mu\text{S/cm}$ in pure and ultra-pure kinds of water.

The sensor types with cell constants $k=1 \text{ cm}^{-1}$ are used in numerous kinds of water without film-forming ingredients up to 20 mS/cm . The cost-effective sensor range LF(T) is used in clear, chemically uncontaminated water.

The sensor ranges LM(P), CK and CKPt can also be used in chemically contaminated kinds of water and a high temperatures.

Conductivity Sensor LMP 001



Sensor for the measurement of the lowest electrolytic conductivities for clear and also chemically contaminated water. With integrated temperature measurement and DIN 4-pin plug. For operation with the controllers Compact DCCa, DMTa, D1Ca

Your benefits

- Measured variable: electrolytic conductivity above $0.01 \text{ }\mu\text{S/cm}$
- Cost-effective sensor for clear, chemically contaminated water
- Integrated Pt 100 for temperature compensation replaces separate temperature sensor and the corresponding sensor fitting

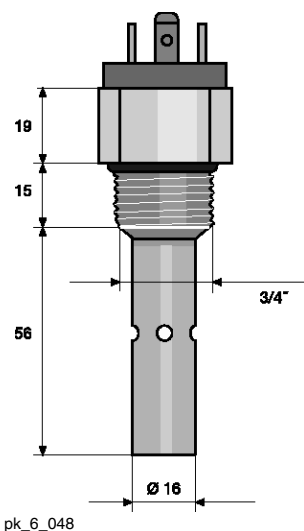

Measuring range	0.01...50 $\mu\text{S/cm}$
Cell constant k	$0.01 \text{ cm}^{-1} \pm 5\%$
Temperature measurement	Pt 100
Medium temperature	0...70 °C
Max. pressure	16.0 bar up to 50 °C,
Sensors	Stainless steel 1.4571
Shaft material	PP
Thread	3/4"
Length when fitted	71 mm
Installation	Inline: direct installation into the pipework, bypass: with or without return of the sample water into the process line
Electrical connection	DIN 4-pin angle plug
Enclosure rating	IP 65
Typical applications	Clean water applications, monitoring ion exchangers and reverse osmosis systems
Resistance to	Ingredients in the water of the target application, taking into account the compatibility of the material
Measuring and control equipment	Compact DCCa, DMTa, D1Ca
Measuring principle, technology	Conductive, 2 electrodes. Integrated temperature measurement

	Order no.
LMP 001	1020508

Please observe the general notes on p. → 1-89 (Overview Table for Conductivity Sensors)



1.4 DULCOTEST® Conductivity Sensors



Conductivity Sensor LMP 001-HT

Sensor for the measurement of the lowest electrolytic conductivity for clear and also chemically contaminated water. For high temperatures, with integrated temperature measurement and DIN 4-pin plug. For operation with the controllers Compact DCCa, DMTa, D1Ca

Your benefits

- Measured variable: electrolytic conductivity above 0.01 µS/cm
- Cost-effective sensor for clear, chemically contaminated water
- Integrated Pt 100 for temperature compensation replaces separate temperature sensor and the corresponding sensor fitting
- Temperature resistance up to 100 °C

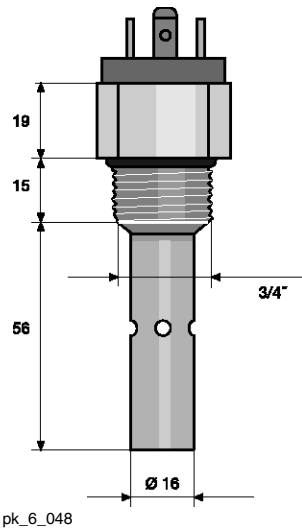

pk_6_048

Measuring range	0.01...50 µS/cm
Cell constant k	0.01 cm ⁻¹ ±5%
Temperature measurement	Pt 100
Medium temperature	0...120 °C
Max. pressure	16.0 bar up to 100 °C,
Sensors	Stainless steel 1.4571
Shaft material	PVDF
Thread	3/4"
Length when fitted	71 mm
Installation	Inline: direct installation into the pipework, bypass: with or without return of the sample water into the process line
Electrical connection	DIN 4-pin angle plug
Enclosure rating	IP 65
Typical applications	General applications at higher temperatures, clean water applications, condensate.
Resistance to	Ingredients in the water of the target application, taking into account the compatibility of the material
Measuring and control equipment	Compact DCCa, DMTa, D1Ca
Measuring principle, technology	Conductive, 2 electrodes. Integrated temperature measurement

Order no.
LMP 001-HT 1020509

Please observe the general notes on p. → 1-89 (Overview Table for Conductivity Sensors)



1.4 DULCOTEST® Conductivity Sensors



Conductivity Sensor LMP 01

Sensor for the measurement of low electrolytic conductivities for clear and also chemically contaminated water. With integrated temperature measurement and DIN 4-pin plug. For operation with the controllers Compact DCCa, DMTa, D1Ca

Your benefits

- Measured variable: electrolytic conductivity above 0.1 µS/cm
- Cost-effective sensor for clear, chemically contaminated water
- Integrated Pt 100 for temperature compensation replaces separate temperature sensor and the corresponding sensor fitting

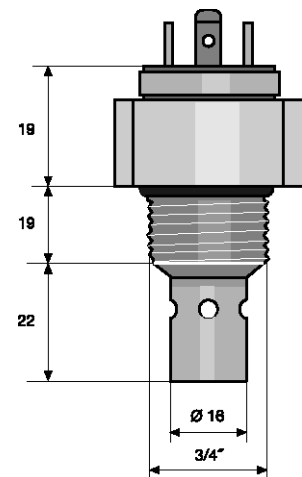

pk_6_049

Measuring range	0.1...500 µS/cm
Cell constant k	0.10 cm ⁻¹ ±5%
Temperature measurement	Pt 100
Medium temperature	0 ... 120 °C
Max. pressure	16.0 bar up to 50 °C,
Sensors	Stainless steel 1.4571
Shaft material	PP
Thread	3/4"
Length when fitted	46 mm
Installation	Inline: direct installation into the pipework, bypass: with or without return of the sample water into the process line
Electrical connection	DIN 4-pin angle plug
Enclosure rating	IP 65
Typical applications	Monitoring ion exchangers, reverse osmosis systems and desalination systems.
Resistance to	Ingredients in the water of the target application, taking into account the compatibility of the material
Measuring and control equipment	Compact DCCa, DMTa, D1Ca
Measuring principle, technology	Conductive, 2 electrodes. Integrated temperature measurement

	Order no.
LMP 01	1020510

Please observe the general notes on p. → 1-89 (Overview Table for Conductivity Sensors)



1.4 DULCOTEST® Conductivity Sensors



Conductivity Sensor LMP 01-TA

Sensor for the measurement of low electrolytic conductivities for clear and also chemically contaminated water. With integrated temperature measurement and DIN 4-pin plug. For operation with the controllers Compact DCCa, DMTa, D1Ca

Your benefits

- Measured variable: electrolytic conductivity above 0.1 µS/cm
- Cost-effective sensor for clear, chemically contaminated water
- Simple installation in tanks and containers by sensor ready mounted in the immersion tube
- Integrated Pt 100 for temperature compensation replaces separate temperature sensor and the corresponding sensor fitting

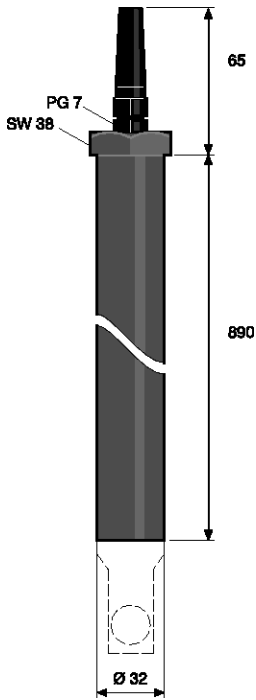

pk_6_053

Measuring range	0.1...500 µS/cm
Cell constant k	0.10 cm ⁻¹ ±5%
Temperature measurement	Pt 100
Medium temperature	0 ... 70 °C
Max. pressure	16.0 bar up to 50 °C,
Sensors	Stainless steel 1.4571
Shaft material	PP
Thread	M 28 x 1.5 for immersion assembly TA-LM
Fitting length	Max. 1 m
Installation	Immersion through an immersion tube
Electrical connection	5 m fixed cable
Enclosure rating	IP 65
Typical applications	Monitoring ion exchangers, reverse osmosis systems and desalination systems.
Resistance to	Ingredients in the water of the target application, taking into account the compatibility of the material
Measuring and control equipment	Compact DCCa, DMTa, D1Ca
Measuring principle, technology	Conductive, 2 electrodes. Integrated temperature measurement

		Order no.
LMP 01-TA	Sensor integrated in immersion fitting	1020512
LMP 01-FE	Replacement sensor for LMP 01-TA with 5 m fixed cable	1020626

Please observe the general notes on p. → 1-89 (Overview Table for Conductivity Sensors)



1.4 DULCOTEST® Conductivity Sensors



Conductivity Sensor LMP 01-HT

Sensor for the measurement of low electrolytic conductivities for clear and also chemically contaminated water. For high temperatures, with integrated temperature measurement and DIN 4-pin plug. For operation with the controllers DCCa, DMTa, D1Ca

Your benefits

- Measured variable: electrolytic conductivity above 0.1 µm/cm
- Cost-effective sensor for clear, chemically contaminated water
- Temperature resistance up to 100 °C
- Integrated Pt 100 for temperature compensation replaces separate temperature sensor and the corresponding sensor fitting

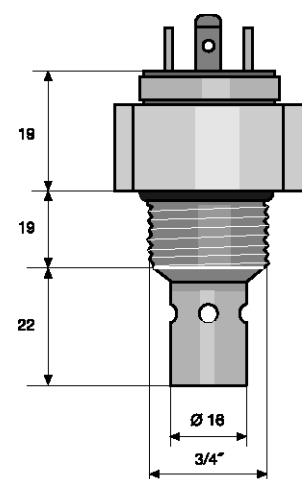

pk_6_049

Measuring range	0.1...500 µS/cm
Cell constant k	0.10 cm ⁻¹ ±5%
Temperature measurement	Pt 100
Medium temperature	0 ... 120 °C
Max. pressure	16.0 bar up to 100 °C,
Sensors	Stainless steel 1.4571
Shaft material	PVDF
Thread	3/4"
Length when fitted	46 mm
Installation	Inline: direct installation into the pipework, bypass: with or without return of the sample water into the process line
Electrical connection	DIN 4-pin angle plug
Enclosure rating	IP 65
Typical applications	General applications at higher temperatures: industrial, process water, condensate
Resistance to	Ingredients in the water of the target application, taking into account the compatibility of the material
Measuring and control equipment	Compact DCCa, DMTa, D1Ca
Measuring principle, technology	Conductive, 2 electrodes. Integrated temperature measurement

LMP 01-HT	Order no. 1020511
------------------	-----------------------------

Please observe the general notes on p. → 1-89 (Overview Table for Conductivity Sensors)



1.4 DULCOTEST® Conductivity Sensors



Conductivity Sensor LFT 1 FE

Cost-effective sensor for the measurement of electrolytic conductivity in clear, uncontaminated water. With integrated temperature measurement and fixed cable connector. For operation with controllers Compact D1Ca and DMTa

Your benefits

- Measured variable: electrolytic conductivity above 10 µS/cm
- Cost-effective sensor for all clear uncontaminated water
- Flexible process connection by the use of sensor fittings for standard pH sensors
- Special graphite electrodes, optimised for a highly dynamic measuring range: 0.01-20 mS/cm
- Integrated Pt 100 for temperature compensation replaces separate temperature sensor and the corresponding sensor fitting
- Fixed cable on the sensor head for difficult ambient conditions

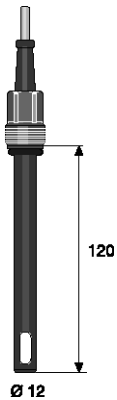

pk_6_085

Measuring range	0.01...20 mS/cm
Cell constant k	1.00 cm ⁻¹ ±5%
Temperature measurement	Pt 100
Medium temperature	0 ... 80 °C (at 1 bar)
Max. pressure	16.0 bar, (at 25 °C)
Sensors	Special graphite
Shaft material	Epoxy
Thread	PG 13.5
Fitting length	120 mm ±3 mm
Installation	Bypass: open outlet or return of the sample water into the process line, inline: direct installation into the pipework; fixed or replaceable (replaceable fitting), tank, channel: Immersion in the immersion tube
Electrical connection	5 m fixed cable (4 x 0.5 mm ²)
Enclosure rating	IP 65
Typical applications	Potable, cooling, industrial water. Sensors of the LF series have only limited applicability for taking measurements in cleaning solutions containing surfactants and media containing solvents.
Resistance to	Unsuitable for chemically contaminated water and water containing film-forming ingredients
Measuring and control equipment	D1Ca, DMTa
Measuring principle, technology	Conductive, 2 electrodes. Integrated temperature measurement

	Order no.
LFT 1 FE	1001374

Please observe the general notes on p. → 1-89 (Overview Table for Conductivity Sensors)



1.4 DULCOTEST® Conductivity Sensors



Conductivity Sensor LFTK 1 FE-5m-shd

Cost-effective sensor for the measurement of electrolytic conductivity in clear, uncontaminated water. With integrated temperature measurement and fixed cable connector (5 m). For operation with controllers Compact DCCa, DMTa

Your benefits

- Measured variable: electrolytic conductivity above 10 µS/cm
- Cost-effective sensor for all clear uncontaminated water
- Flexible process connection by the use of sensor fittings for standard pH sensors
- Special graphite electrodes, optimised for a highly dynamic measuring range: 0.01-20 mS/cm
- Integrated Pt 1000 for precise temperature compensation in limited temperature ranges replaces separate temperature sensor and the corresponding sensor fitting
- Fixed cable on the sensor head for difficult ambient conditions

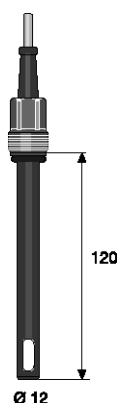

pk_6_085

Measuring range	0.01 ... 20 mS/cm
Cell constant k	1.00 cm ⁻¹ ±5%
Temperature measurement	Pt 1000
Medium temperature	0 ... 80 °C (at 1 bar)
Max. pressure	16.0 bar, (at 25 °C)
Sensors	Special graphite
Shaft material	Epoxy
Thread	PG 13.5
Fitting length	120 mm ±3 mm
Installation	Bypass: with or without return of the sample water into the process line, inline: direct installation into the pipework; fixed or replaceable (replaceable fitting), tank, channel: Immersion in the immersion tube
Electrical connection	5 m fixed cable (4 x 0.25 mm ²), screened
Enclosure rating	IP 65
Typical applications	Potable, cooling, industrial water.
Resistance to	Unsuitable for chemically contaminated water and water containing film-forming ingredients
Measuring and control equipment	Compact DCCa, DMTa
Measuring principle, technology	Conductive, 2 electrodes. Integrated temperature measurement

	Order no.
LFTK 1 FE-5m-shd	1046132

Please observe the general notes on p. → 1-89 (Overview Table for Conductivity Sensors)



1.4 DULCOTEST® Conductivity Sensors



Conductivity Sensor LFTK 1 FE-3m-shd

Cost-effective sensor for the measurement of electrolytic conductivity in clear, uncontaminated water. With integrated temperature measurement and fixed cable connector (3 m). For operation with controllers Compact DCCa, DMTa

Your benefits

- Measured variable: electrolytic conductivity above 10 µS/cm
- Cost-effective sensor for all clear uncontaminated water
- Flexible process connection by the use of sensor fittings for standard pH sensors
- Special graphite electrodes, optimised for a highly dynamic measuring range: 0.01-20 mS/cm
- Integrated Pt 1000 for precise temperature compensation in limited temperature ranges replaces separate temperature sensor and the corresponding sensor fitting
- Fixed cable on the sensor head for difficult ambient conditions

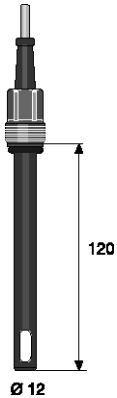

pk_6_085

Measuring range	0.01...20 mS/cm
Cell constant k	1.00 cm ⁻¹ ±5%
Temperature measurement	Pt 1000
Medium temperature	0 ... 80 °C (at 1 bar)
Max. pressure	16.0 bar, (at 25 °C)
Sensors	Special graphite
Shaft material	Epoxy
Thread	PG 13.5
Fitting length	120 mm ±3 mm
Installation	Bypass: with or without return of the sample water into the process line, inline: direct installation into the pipework; fixed or replaceable (replaceable fitting), tank, channel: Immersion in the immersion tube
Electrical connection	3 m fixed cable (4 x 0.25 mm ²), screened
Enclosure rating	IP 65
Typical applications	Potable, cooling, industrial water. Sensors of the LF series have only limited applicability for taking measurements in cleaning solutions containing surfactants and media containing solvents.
Resistance to	Unsuitable for chemically contaminated water and water containing film-forming ingredients
Measuring and control equipment	Compact DCCa, DMTa
Measuring principle, technology	Conductive, 2 electrodes. Integrated temperature measurement

	Order no.
LFTK 1 FE-3m-shd	1046010

Please observe the general notes on p. → 1-89 (Overview Table for Conductivity Sensors)



1.4 DULCOTEST® Conductivity Sensors

Conductivity Sensor LF 1 DE



Cost-effective sensor for the measurement of electrolytic conductivity in clear, uncontaminated water. For applications with a constant temperature, with DIN 4-pin plug. For operation with controllers Compact DCCa, DMTa, D1Ca

Your benefits

- Measured variable: electrolytic conductivity above 10 µS/cm
- Cost-effective sensor for all clear uncontaminated water
- Flexible process connection by the use of sensor fittings for standard pH sensors
- Special graphite electrodes, optimised for a highly dynamic measuring range: 0.01-20 mS/cm
- Cost-effective version without integral temperature measurement with constant temperature of the medium to be measured
- DIN 4-pin plug for simple installation

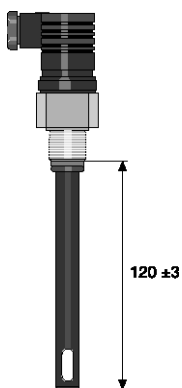

pk_6_086

Measuring range	0.01 ... 20 mS/cm
Cell constant k	1.00 cm ⁻¹ ± 5%
Temperature measurement	None, only for applications with constant temperature
Medium temperature	0 ... 80 °C (at 1 bar)
Max. pressure	16.0 bar, (at 25 °C)
Sensors	Special graphite
Shaft material	Epoxy
Thread	PG 13.5
Fitting length	120 mm ± 3 mm
Installation	Bypass: with or without return of the sample water into the process line, inline: direct installation into the pipework; fixed or replaceable (replaceable fitting), tank, channel: Immersion in the immersion tube
Electrical connection	DIN 4-pin angle plug
Enclosure rating	IP 65
Typical applications	Potable, cooling, industrial water. Sensors of the LF series have only limited applicability for taking measurements in cleaning solutions containing surfactants and media containing solvents.
Resistance to	Unsuitable for chemically contaminated water and water containing film-forming ingredients
Measuring and control equipment	Compact DCCa, DMTa, D1Ca
Measuring principle, technology	Conductive, 2 electrodes

	Order no.
LF 1 DE	1001375

Please observe the general notes on p. → 1-89 (Overview Table for Conductivity Sensors)



1.4 DULCOTEST® Conductivity Sensors



Conductivity Sensor LFT 1 DE

Cost-effective sensor for the measurement of electrolytic conductivity in clear, uncontaminated water. With integrated temperature measurement and DIN 4-pin plug. For operation with controllers Compact DCCa, DMTa, D1Ca

Your benefits

- Measured variable: electrolytic conductivity above 10 µS/cm
- Cost-effective sensor for all clear, uncontaminated types of water
- Flexible process connection by the use of sensor fittings for standard pH sensors
- Special graphite electrodes, optimised for a highly dynamic measuring range: 0.01-20 mS/cm
- Integrated Pt 100 for temperature compensation replaces separate temperature sensor and the corresponding sensor fitting
- DIN 4-pin plug for simple installation

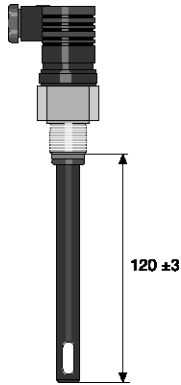

pk_6_086

Measuring range	0.01...20 mS/cm
Cell constant k	1.00 cm ⁻¹ ±5%
Temperature measurement	Pt 100
Medium temperature	0 ... 80 °C (at 1 bar)
Max. pressure	16.0 bar, (at 25 °C)
Sensors	Special graphite
Shaft material	Epoxy
Thread	PG 13.5
Fitting length	120 mm ±3 mm
Installation	Bypass: with or without return of the sample water into the process line, inline: direct installation into the pipework; fixed or replaceable (replaceable fitting), tank, channel: Immersion in the immersion tube
Electrical connection	DIN 4-pin angle plug
Enclosure rating	IP 65
Typical applications	Potable, cooling, industrial water. Sensors of the LF series have only limited applicability for taking measurements in cleaning solutions containing surfactants and media containing solvents.
Resistance to	Unsuitable for chemically contaminated water and water containing film-forming ingredients
Measuring and control equipment	Compact DCCa, DMTa, D1Ca
Measuring principle, technology	Conductive, 2 electrodes. Integrated temperature measurement

	Order no.
LFT 1 DE	1001376

Please observe the general notes on p. → 1-89 (Overview Table for Conductivity Sensors)



1.4 DULCOTEST® Conductivity Sensors



Conductivity Sensor LFTK 1 DE

Cost-effective sensor for the measurement of the electrolytic conductivity in clear, uncontaminated water with integral temperature measurement and DIN 4-pin plug. For operation with controllers Compact DCCa, DMTa

Your benefits

- Measured variable: electrolytic conductivity above 10 µS/cm
- Cost-effective sensor for all clear uncontaminated water
- Flexible process connection by the use of sensor fittings for standard pH sensors
- Special graphite electrodes, optimised for a highly dynamic measuring range: 0.01-20 mS/cm
- Integrated Pt 100 for temperature compensation replaces separate temperature sensor and the corresponding sensor fitting
- DIN 4-pin plug for simple installation

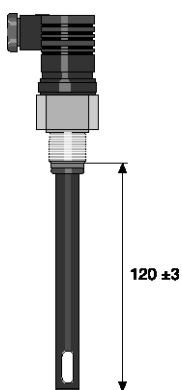

pk_6_086

Measuring range	0.01 ... 20 mS/cm
Cell constant k	1.00 cm ⁻¹ ±5%
Temperature measurement	Pt 1000
Medium temperature	0 ... 80 °C (at 1 bar)
Max. pressure	16.0 bar, (at 25 °C)
Sensors	Special graphite
Shaft material	Epoxy
Thread	PG 13.5
Fitting length	120 mm ±3 mm
Installation	Bypass: with or without return of the sample water into the process line, inline: direct installation into the pipework; fixed or replaceable (replaceable fitting), tank, channel: Immersion in the immersion tube
Electrical connection	DIN 4-pin angle plug
Enclosure rating	IP 65
Typical applications	Potable, cooling, industrial water. Sensors of the LF series have only limited applicability for taking measurements in cleaning solutions containing surfactants and media containing solvents.
Resistance to	Unsuitable for chemically contaminated water and water containing film-forming ingredients
Measuring and control equipment	Compact DCCa, DMTa
Measuring principle, technology	Conductive, 2 electrodes. Integrated temperature measurement

	Order no.
LFTK 1 DE	1002822

Please observe the general notes on p. → 1-89 (Overview Table for Conductivity Sensors)



1.4 DULCOTEST® Conductivity Sensors



Conductivity Sensor LFT 1 1/2"

Cost-effective sensor for the measurement of electrolytic conductivity in clear, uncontaminated water. With integrated temperature measurement and DIN 4-pin plug and 1/2-inch screw thread. For operation with controllers Compact DCCa, DMTa, D1Ca

Your benefits

- Measured variable: electrolytic conductivity above 10 µS/cm
- Cost-effective sensor for all clear, uncontaminated types of water
- Hydraulic connector with 1/2" thread as an alternative to the corresponding standard design with PG 13.5 thread
- Special graphite electrodes, optimised for a highly dynamic measuring range: 0.01-20 mS/cm
- Integrated Pt 100 for temperature compensation replaces separate temperature sensor and the corresponding sensor fitting
- DIN 4-pin plug for simple installation

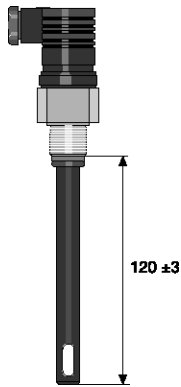

pk_6_086

Measuring range	0.01...20 mS/cm
Cell constant k	1.00 cm ⁻¹ ±5%
Temperature measurement	Pt 100
Medium temperature	0 ... 80 °C (at 1 bar)
Max. pressure	16.0 bar, (at 25 °C)
Sensors	Special graphite
Shaft material	Epoxy
Thread	1/2"
Fitting length	120 mm ±3 mm
Installation	Bypass: with or without return of the sample water into the process line, inline: direct installation into the pipework; fixed or replaceable (replaceable fitting), tank, channel: Immersion in the immersion tube
Electrical connection	DIN 4-pin angle plug
Enclosure rating	IP 65
Typical applications	Potable, cooling, industrial water. Sensors of the LF series have only limited applicability for taking measurements in cleaning solutions containing surfactants and media containing solvents.
Resistance to	Unsuitable for chemically contaminated water and water containing film-forming ingredients
Measuring and control equipment	Compact DCCa, DMTa, D1Ca
Measuring principle, technology	Conductive, 2 electrodes. Integrated temperature measurement

	Order no.
LFT 1 1/2"	1001378

Please observe the general notes on p. → 1-89 (Overview Table for Conductivity Sensors)



1.4 DULCOTEST® Conductivity Sensors

Conductivity Sensor LFTK 1 1/2"



Cost-effective sensor for the measurement of electrolytic conductivity in clear, uncontaminated water. With integrated temperature measurement and DIN 4-pin plug and 1/2-inch screw thread. For operation with controllers Compact DCCa, DMTa

Your benefits

- Measured variable: electrolytic conductivity above 10 µC/cm
- Cost-effective sensor for all clear, uncontaminated types of water
- Hydraulic connector with 1/2" thread as an alternative to the corresponding standard design with PG 13.5 thread
- Special graphite electrodes, optimised for a highly dynamic measuring range: 0.01-20 mS/cm
- Integrated Pt 1000 for precise compensation in limited temperature ranges and with longer cables. Replaces separate temperature sensor and the corresponding sensor fitting
- DIN 4-pin plug for simple installation

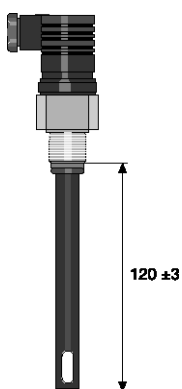

pk_6_086

Measuring range	0.01 ... 20 mS/cm
Cell constant k	1.00 cm ⁻¹ ±5%
Temperature measurement	Pt 1000
Medium temperature	0 ... 80 °C (at 1 bar)
Max. pressure	16.0 bar, (at 25 °C)
Sensors	Special graphite
Shaft material	Epoxy
Thread	1/2"
Fitting length	120 mm ±3 mm
Installation	Bypass: with or without return of the sample water into the process line, inline: direct installation into the pipework; fixed or replaceable (replaceable fitting), tank, channel: Immersion in the immersion tube
Electrical connection	DIN 4-pin angle plug
Enclosure rating	IP 65
Typical applications	Potable, cooling, industrial water. Sensors of the LF series have only limited applicability for taking measurements in cleaning solutions containing surfactants and media containing solvents.
Resistance to	Unsuitable for chemically contaminated water and water containing film-forming ingredients
Measuring and control equipment	Compact DCCa, DMTa
Measuring principle, technology	Conductive, 2 electrodes. Integrated temperature measurement

	Order no.
LFTK 1 1/2"	1002823

Please observe the general notes on p. → 1-89 (Overview Table for Conductivity Sensors)



1.4 DULCOTEST® Conductivity Sensors



Conductivity Sensor CK 1

Sensor for the measurement of the electrolytic conductivity in clear, chemically contaminated water with high but constant temperature with DIN 4-pin plug. For operation with the controllers Compact DCCa, DMTa, D1Ca

Your benefits

- Measured variable: electrolytic conductivity above 10 µS/cm
- Resistant to water ingredients in target applications thanks to injection-moulded design without adhesive or seals
- High temperature resistance up to 150 °C

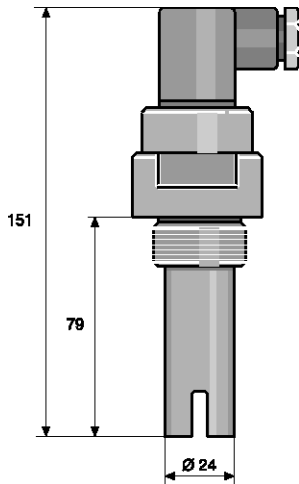

pk_6_046

Measuring range	0.01...20 mS/cm
Cell constant k	1.00 cm ⁻¹ ±5%
Temperature measurement	None, only for applications with constant temperature
Medium temperature	0 ... 150 °C (at 1 bar)
Max. pressure	16.0 bar, (at 20 °C)
Sensors	Special graphite
Shaft material	PES
Thread	R 1"
Length when fitted	79 mm
Installation	Bypass: with or without return of the sample water into the process line, inline: direct installation into the pipework; fixed or replaceable (replaceable fitting), tank, channel: Immersion in the immersion tube
Electrical connection	DIN 4-pin angle plug
Enclosure rating	IP 65
Typical applications	Cooling, industrial, process water, tank and pipe, cleaning systems in breweries, dairies, media separation.
Resistance to	Ingredients in the water of the target application, taking into account the compatibility of the material
Measuring and control equipment	Compact DCCa, DMTa, D1Ca
Measuring principle, technology	Conductive, 2 electrodes

Order no.

CK 1

305605



1.4 DULCOTEST® Conductivity Sensors

Conductivity Sensor CKPt 1



Sensor for the measurement of the electrolytic conductivity for clear, chemically contaminated water and higher temperatures. With integrated temperature measurement and DIN 4-pin plug. For operation with the controllers Compact DCCa, DMTa, D1Ca

Your benefits

- Measured variable: electrolytic conductivity above 10 µS/cm
- Resistant to water ingredients in target applications thanks to injection-moulded design without adhesive or seals
- High temperature resistance up to 150 °C
- Integrated Pt 100 for temperature compensation replaces separate temperature sensor and the corresponding sensor fitting

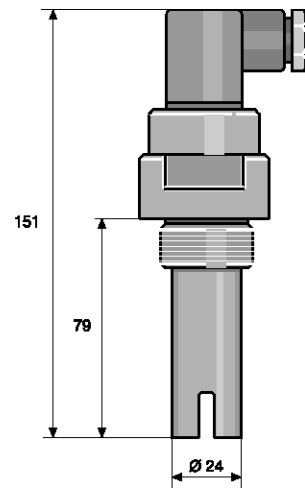

pk_6_046

Measuring range	0.01...20 mS/cm
Cell constant k	1.00 cm ⁻¹ ±5%
Temperature measurement	Pt 100
Medium temperature	0 ... 150 °C (at 1 bar)
Max. pressure	16.0 bar, (at 20 °C)
Sensors	Special graphite
Shaft material	PES
Thread	R 1"
Length when fitted	79 mm
Installation	Bypass: with or without return of the sample water into the process line, inline: direct installation into the pipework; fixed or replaceable (replaceable fitting), tank, channel: Immersion in the immersion tube
Electrical connection	DIN 4-pin angle plug
Enclosure rating	IP 65
Typical applications	Cooling, industrial, process water, tank and pipe cleaning systems in breweries and dairies, separation of media.
Resistance to	Ingredients in the water of the target application, taking into account the compatibility of the material
Measuring and control equipment	Compact DCCa, DMTa, D1Ca
Measuring principle, technology	Conductive, 2 electrodes. Integrated temperature measurement

	Order no.
CKPt 1	305606



1.4 DULCOTEST® Conductivity Sensors



Conductivity Sensor LM 1

Sensor for the measurement of the electrolytic conductivity for clear and also chemically contaminated water. With DIN 4-pin plug. For operation with the controllers Compact DCCa, DMTa, D1Ca

Your benefits

- Measured variable: electrolytic conductivity above 0.1 mS/cm
- Cost-effective sensor for clear, chemically contaminated water
- Resistant to the constituents in the water of the target application

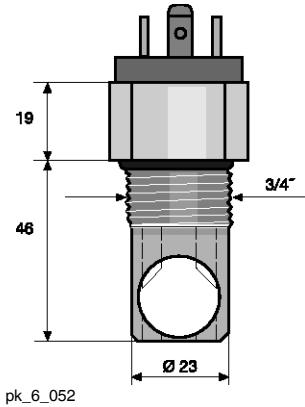

Measuring range	0.1...20 mS/cm
Cell constant k	1.00 cm ⁻¹ ±5%
Temperature measurement	None, only for applications with constant temperature
Medium temperature	0 ... 70 °C (at 1 bar)
Max. pressure	16.0 bar, (at 50 °C)
Sensors	Graphite
Shaft material	PP
Thread	3/4"
Length when fitted	46 mm
Installation	Inline: direct installation into the pipework, bypass: with or without return of the sample water into the process line
Electrical connection	DIN 4-pin angle plug
Enclosure rating	IP 65
Typical applications	Potable, cooling, industrial, process water, Feed chemical separation
Resistance to	Ingredients in the water of the target application, taking into account the compatibility of the material
Measuring and control equipment	Compact DCCa, DMTa, D1Ca
Measuring principle, technology	Conductive, 2 electrodes

Order no.

LM 1

740433



1.4 DULCOTEST® Conductivity Sensors

Conductivity Sensor LM 1-TA



Sensor for the measurement of the electrolytic conductivity for clear and also chemically contaminated water. Completely mounted in an immersion fitting. For operation with the controllers Compact DCCa, DMTa, D1Ca

Your benefits

- Measured variable: electrolytic conductivity above 0.1 mS/cm
- Cost-effective sensor for clear, chemically contaminated water
- Resistant to the ingredients in the water of the target applications
- Simple installation in tanks, containers etc. by sensor ready mounted in the immersion tube

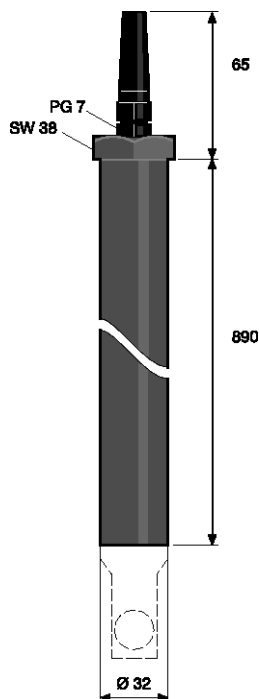

pk_6_053

Measuring range	0.1...20 mS/cm
Cell constant k	1.00 cm ⁻¹ ±5%
Temperature measurement	None, only for applications with constant temperature
Medium temperature	0 ... 70 °C (at 1 bar)
Max. pressure	16.0 bar, (at 50 °C)
Sensors	Graphite
Shaft material	PP
Thread	M 28 x 1.5 for TA-LM in-line probe fitting
Fitting length	Max. 1 m
Installation	Tank, Gerinne: Eintauchen über Tauchrohr
Electrical connection	5 m fixed cable, screened
Enclosure rating	IP 65
Typical applications	Potable, cooling, industrial, process water, media separation
Resistance to	Ingredients in the water of the target application, taking into account the compatibility of the material
Measuring and control equipment	Compact DCCa, DMTa, D1Ca
Measuring principle, technology	Conductive, 2 electrodes

		Order no.
LM 1-TA	Sensor integrated in immersion fitting	1020528
LM 1-FE	Replacement sensor for LM 1-TA	1020627



1.4 DULCOTEST® Conductivity Sensors



Conductivity Sensor LMP 1

Sensor for the measurement of the electrolytic conductivity for clear and also chemically contaminated water. With integrated temperature measurement with DIN 4-pin plug. For operation with the controllers Compact DCCa, DMTa, D1Ca

Your benefits

- Measured variable: electrolytic conductivity above 0.1 mS/cm
- Cost-effective sensor for clear, chemically contaminated water
- Resistant to the ingredients in the water of the target applications
- Integrated Pt 100 for temperature compensation replaces separate temperature sensor and the corresponding sensor fitting

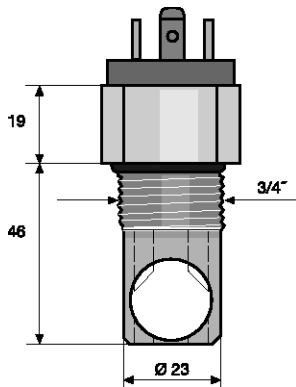

pk_6_052

Measuring range	0.1...20 mS/cm
Cell constant k	1.00 cm ⁻¹ ±5%
Temperature measurement	Pt 100
Medium temperature	0 ... 70 °C (at 1 bar)
Max. pressure	16.0 bar, (at 50 °C)
Sensors	Graphite
Shaft material	PP
Thread	3/4"
Length when fitted	46 mm
Installation	Inline: direct installation into the pipework, bypass: with or without return of the sample water into the process line
Electrical connection	DIN 4-pin angle plug
Enclosure rating	IP 65
Typical applications	Potable, cooling, industrial, process water, media separation
Resistance to	Ingredients in the water of the target application, taking into account the compatibility of the material
Measuring and control equipment	Compact DCCa, DMTa, D1Ca
Measuring principle, technology	Conductive, 2 electrodes. Integrated temperature measurement

	Order no.
LMP 1	1020513

Please observe the general notes on p. → 1-89 (Overview Table for Conductivity Sensors)



1.4 DULCOTEST® Conductivity Sensors



Conductivity Sensor LMP 1-TA

Sensor for the measurement of the electrolytic conductivity for clear and also chemically contaminated water. With integrated temperature measurement, ready mounted in an immersion fitting. For operation with the controllers Compact DCCa, DMTa, D1Ca

Your benefits

- Measured variable: electrolytic conductivity above 0.1 mS/cm
- Cost-effective sensor for clear, chemically contaminated water
- Resistant to the ingredients in the water of the target applications
- Integrated Pt 100 for temperature compensation replaces separate temperature sensor and the corresponding sensor fitting
- Simple installation in tanks, containers etc. by sensor ready mounted in the immersion tube

Measuring range	0.1...20 mS/cm
Cell constant k	1.00 cm ⁻¹ ±5%
Temperature measurement	Pt 100
Medium temperature	0 ... 70 °C (at 1 bar)
Max. pressure	16.0 bar, (at 50 °C)
Sensors	Graphite
Shaft material	PP
Thread	M 28 x 1.5 for TA-LM in-line probe fitting
Length when fitted	1 m
Installation	Tank, Gerinne: Eintauchen über Tauchrohr
Electrical connection	5 m fixed cable, screened
Enclosure rating	IP 65
Typical applications	Potable, cooling, industrial, process water, media separation
Resistance to	Ingredients in the water of the target application, taking into account the compatibility of the material
Measuring and control equipment	Compact DCCa, DMTa, D1Ca
Measuring principle, technology	Conductive, 2 electrodes

		Order no.
LMP 1-TA	sensor integrated in immersion fitting	1020525
LMP 1-FE	Replacement sensor for LMP 1-TA	1020727

Please observe the general notes on p. → 1-89 (Overview Table for Conductivity Sensors)



1.4 DULCOTEST® Conductivity Sensors



Conductivity Sensor LMP 1-HT

Sensor for the measurement of the electrolytic conductivity for clear and also chemically contaminated water. For high temperatures, with integrated temperature measurement and DIN 4-pin plug. For operation with the controllers Compact DCCa, DMTa, D1Ca

Your benefits

- Measured variable: electrolytic conductivity above 0.1 mS/cm
- Cost-effective sensor for clear, chemically contaminated water
- Resistant to the ingredients in the water of the target applications
- Integrated Pt 100 for temperature compensation replaces separate temperature sensor and the corresponding sensor fitting
- Temperature resistance up to 100 °C

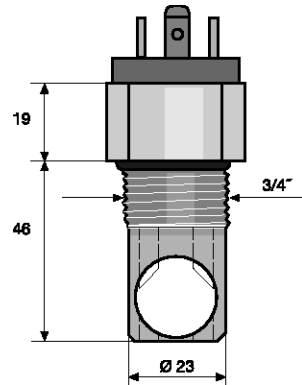

pk_6_052

Measuring range	0.1...20 mS/cm
Cell constant k	1.00 cm ⁻¹ ±5%
Temperature measurement	Pt 100
Medium temperature	0 ... 120 °C (at 1 bar)
Max. pressure	16.0 bar, (at 100 °C)
Sensors	Graphite
Shaft material	PVDF
Thread	3/4"
Length when fitted	46 mm
Installation	Inline: direct installation into the pipework, bypass: with or without return of the sample water into the process line
Electrical connection	DIN 4-pin angle plug
Enclosure rating	IP 65
Typical applications	General applications at higher temperatures process water, process water from electroplating, media separation, with CIP (cleaning in place)
Resistance to	Ingredients in the water of the target application, taking into account the compatibility of the material
Measuring and control equipment	Compact DCCa, DMTa, D1Ca
Measuring principle, technology	Conductive, 2 electrodes. Integrated temperature measurement

	Order no.
LMP 1-HT	1020524

Please observe the general notes on p. → 1-89 (Overview Table for Conductivity Sensors)



1.4 DULCOTEST® Conductivity Sensors



NEW

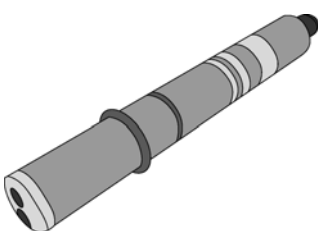

P_DT_0078_SW

Conductivity sensor CCT 1-mA

Sensor for the measurement of electrolytic conductivities for clear and also chemically contaminated water. With integrated temperature measurement and factory-calibrated 4...20 mA output signal. For operation with the controllers diaLog DAC, AEGIS® II, DULCOMARIN®.

Your benefits

- Measured variable: electrolytic conductivity up to 20 mS/cm
- Reliable 4-20 mA output signal for the flexible connection to different measuring devices
- Integrated temperature sensor for temperature compensation replaces separate temperature sensor and the corresponding sensor fitting

Measuring range	0.2...20 mS/cm
Temperature measurement	NTC, integrated
Medium temperature	0 ... 50 °C(at 1 bar)
Max. pressure	8.0 bar, (at 25 °C)
Sensor head	PMMA
Sensors	Special graphite
Shaft material	PVC
Fitting length	51 mm / 71 mm
Installation	Bypass via sensor fittings DGM, DLGIII or installation into G1" PP pipe via INLI sensor fitting
Electrical connection	4-wire cable/0.25 mm ² / cable diameter 5.7 mm
Power supply DC	12...36 V DC
Voltage 4 ... 20 mA loop	4... 20 mA loop + 7.5 V
Output signal	4 ... 20 mA, temperature-compensated, factory-calibrated, galvanically isolated
Enclosure rating	IP 65
Typical applications	Cooling, industrial, process water, general water with higher salt content up to 20 mS/cm
Resistance to	Ingredients in the water of the target application, taking into account the compatibility of the material
Measuring and control equipment	diaLog DAC, AEGIS® II, DULCOMARIN®
Measuring principle	Conductive, 2 electrodes. Integrated temperature measurement, integrated 4...20 mA transducer

Order no.	
CCT 1-mA-20 mS/cm	1081545

Please observe the general notes on p. → 1-89 (Overview Table for Conductivity Sensors)



1.4 DULCOTEST® Conductivity Sensors

1.4.3 Inductive Conductivity Sensors

Inductive conductivity sensors consist of a transducer, encapsulated in an inert material. The electrolytic conductivity is measured inductively without direct contact with the medium.

The sensors are used to measure electrolytic conductivity over a wide measuring range, even in heavily contaminated and/or aggressive media and, as such, offer particularly low maintenance operation. The sensors are particularly suitable for measuring high conductivities, as no electrode polarisation occurs. The inductive conductivity sensors are operated using the Compact controller DCCa xx L6 ... The controller includes the testing and calibration kit (Order no. 1026958).

Conductivity Sensor ICT 1

Note: Will be replaced by type ICT 5 in the 2nd quarter of 2018.

Cost-effective inductive conductivity sensor, suitable for high electrolytic conductivities above 200 µS/cm. Also suitable for chemically contaminated water and film-forming media. For installation in pipework

Your benefits

- Measured variable: electrolytic conductivity. The inductive (non-contact) measuring principle permits applications in chemically contaminated types of water and in film-forming media
- There is no need for adhesive or seals as the sensor is fully embedded in PP
- Measurements at high conductivity values of up to 1,000 mS/cm are possible without interfering polarisation by means of the high measuring range dynamics of the inductive measuring principle
- Simple installation in a PVC pipe by bonding the DN 40 adhesive connector supplied into a standard T-piece and screwing in the sensor using the union nut supplied. A DN 40 welded connector is optionally available for use in PP pipework

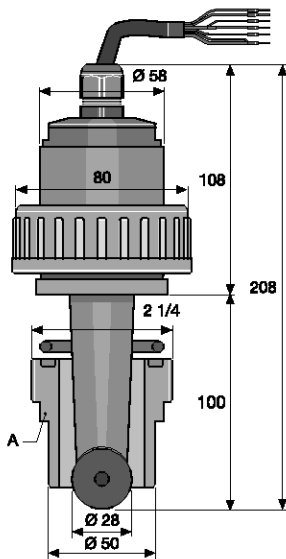

P_MSRZ_0013_SW1
A=Adhesive joints PVC, Fusion joints PP, DN 40

Measuring range	0.2...1,000 mS/cm
Cell constant k	8.5 cm ⁻¹ ±5%
Measuring accuracy	< 1% relative to final value of measuring range
Temperature compensation	Pt 100
Process chemical temperature	0...70 °C
Max. pressure	16.0 bar up to 40 °C, 1.0 bar up to 70 °C
Material	Sensor: PP Seals: FKM
Electrical connection	7 m fixed cable
Enclosure rating	IP 65
Typical applications	All types of soiled water, desalination control in cooling towers, control of electroplating baths, Cleaning in Place (CIP), product monitoring, sea water
Resistance to Installation	PP-compatible chemicals, deposit-forming media With union nut, 2 1/4 inch internal thread, DN 40, PVC incl. DN 40 bonded nozzle with 2 1/4 external thread for fitting in DN 40 PVC standard tube (within scope of supply). The corresponding set-in nozzle for fitting in PP standard tube is available as an accessory.
Measuring and control equipment	D1C for inductive conductivity
Measuring principle, technology	Inductive, 2 coils. Integrated temperature measurement

Welding socket for T-piece (PP) type ICT 1 → 1-133, Controller DULCOMETER® D1Cb/D1Cc for all Measured Variables

	Order no.
ICT 1	1023244

1.4 DULCOTEST® Conductivity Sensors

Conductivity Sensor ICT 1-IMA

Note: Will be replaced by type ICT 5 IMA in the 2nd quarter of 2018.

Cost-effective inductive conductivity sensor, suitable for high electrolytic conductivities above 200 µS/cm. Also suitable for chemically contaminated water and film-forming media. Completely integrated in an immersion pipe



Your benefits

- Measured variable: electrolytic conductivity. The inductive (non-contact) measuring principle permits applications in chemically contaminated types of water and in film-forming media
- There is no need for adhesive or seals as the sensor is fully embedded in PP
- Measurements at high conductivity values of up to 1,000 mS/cm are possible without interfering polarisation by means of the high measuring range dynamics of the inductive measuring principle
- Simple installation in tanks, containers etc. thanks to sensor ready mounted in the immersion tube

Measuring range	0.2...1,000 mS/cm
Cell constant k	8.5 cm ⁻¹ ±5%
Measuring accuracy	< 1% relative to final value of measuring range
Temperature compensation	Pt 100
Process chemical temperature	0...70 °C
Max. pressure	8.0 bar up to 40 °C, 1.0 bar up to 70 °C
Material	Sensor and immersion tube: PP Seals: FKM
Long immersion pipe	1 m / 2 m
Electrical connection	7 m fixed cable
Enclosure rating	IP 65
Typical applications	Polluted waste water of all kinds, blowdown control in cooling towers, control of electroplating baths, Cleaning in Place (CIP), product monitoring, sea water

Resistance to	PP-compatible chemicals, deposit-forming media
Long immersion pipe	Immersion sensor complete with 1 m immersion pipe or 2 m immersion pipe. The fitting accessories for the immersion valve IPHa 3-PP can also be used for the immersion sensor.

Measuring and control equipment	Compact controller DCCa
Measuring principle, technology	Inductive, 2 coils. Integrated temperature measurement

PP immersion assembly type IPHa 3 -PP , Controller DULCOMETER® D1Cb/D1Cc for all Measured Variables

	Order no.
ICT 1-IMA 1 m	1023349
ICT 1-IMA 2 m	1023351

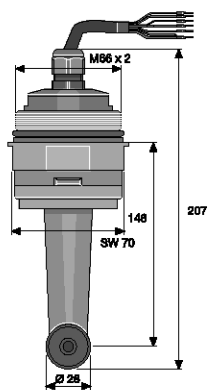

pk_6_089

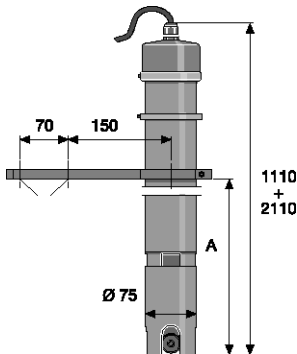

pk_6_088

A = min. 155 mm / max. 1 m or 2 m

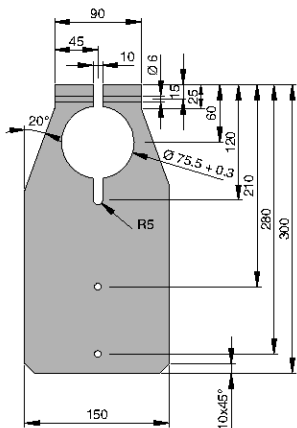

P_AC_0262_SW1



1.4 DULCOTEST® Conductivity Sensors

Conductivity sensor ICT 5

Note: Will replace type ICT 1 in the 2nd quarter of 2018.

Cost-effective inductive conductivity sensor, suitable for high electrolytic conductivities above 200 µS/cm. Also suitable for chemically contaminated water and film-forming media. For installation in pipework

Your benefits

- Measured variable: electrolytic conductivity. The inductive (non-contact) measuring principle permits applications in chemically contaminated types of water and in film-forming media
- Complete with injection moulded PP sensor head, no apparent bonds, seals
- Measurements at high conductivity values of up to 2,000 mS/cm are possible without interfering polarisation by means of the high measuring range dynamics of the inductive measuring principle
- Simple installation in PVC pipework by bonding the DN 40 adhesive connector supplied into a standard T-piece and screwing in the sensor using the union nut supplied.
- A DN 40 welded connector is optionally available for use in PP pipework

NEW

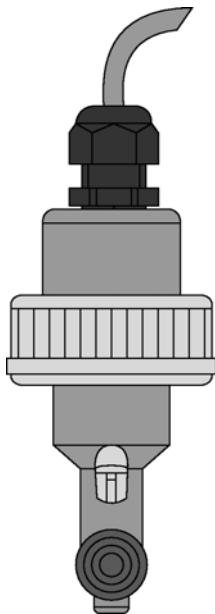

P_DT_0081_SW

Measuring range	0.2...2,000 mS/cm
Cell constant k	6.25 cm ⁻¹ ±5%
Measuring accuracy	< 1 % based on the full-scale reading
Temperature sensor	Pt 1000
Process chemical temperature	-10...80 °C
Max. pressure	10.0 bar up to 20 °C, 6.0 bar up to 60 °C, 0.0 bar at 80 °C
Min. pressure	-0.1 bar at -10 ... 80 °C
Sensor material	PP
Seals	EPDM
Electrical connection	7 m fixed cable
Enclosure rating	IP 65
Typical applications	Polluted waste water of all kinds, blowdown control in cooling towers, control of electroplating baths, Cleaning in Place (CIP), product monitoring, sea water
Resistance to	Ingredients in the water of the target application, taking into account compatibility to PP/EPDM, deposit-forming media
Installation	With union nut, PVC, 1 1/2 inch female thread, including DN 40 bonded nozzle with 1 1/2 inch external thread for fitting in DN 40 PVC standard pipes (included in the scope of delivery). The corresponding set-in nozzle for fitting in PP standard pipe is available as an accessory
Measuring and control equipment	Compact controller DCCa
Measuring principle, technology	Inductive, 2 coils. Integrated temperature measurement

ICT 5	Order no. on request
--------------	--------------------------------



1.4 DULCOTEST® Conductivity Sensors

Conductivity Sensor ICT 5-IMA

Note: Will replace type ICT 1 IMA in the 2nd quarter of 2018.

Cost-effective inductive conductivity sensor, suitable for high electrolytic conductivities above 200 µS/cm. Also suitable for chemically contaminated water and film-forming media. Completely integrated in an immersion pipe



NEW

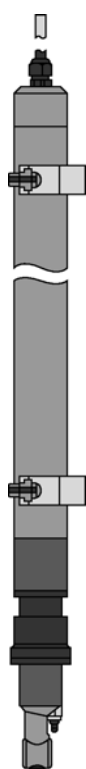

Your benefits

- Measured variable: electrolytic conductivity. The inductive (non-contact) measuring principle permits applications in chemically contaminated types of water and in film-forming media
- Complete with injection moulded PP sensor head, no apparent bonds, seals
- Measurements at high conductivity values of up to 2,000 mS/cm are possible without interfering polarisation by means of the high measuring range dynamics of the inductive measuring principle
- Simple installation in tanks, containers etc. thanks to sensor ready mounted in the immersion tube

Measuring range	0.2...2,000 mS/cm
Cell constant k	6.25 cm ⁻¹ ±5%
Measuring accuracy	< 1 % based on the full-scale reading
Temperature sensor	Pt 1000
Process chemical temperature	-10...60 °C
Max. pressure	0.0 bar
Min. pressure	-0.1 bar at -10 ... 60 °C
Sensor material	PP
Immersion pipe material	PP
Sensor guard material	SS 1.4301, AISI 304
Seals	EPDM
Electrical connection	7 m fixed cable
Enclosure rating	IP 65
Typical applications	Polluted waste water of all kinds, blowdown control in cooling towers, control of electroplating baths, Cleaning in Place (CIP), product monitoring, sea water
Resistance to	Ingredients in the water of the target application, taking into account compatibility to PP/EPDM, deposit-forming media
Installation	Immersion with immersion length 1 m
Measuring and control equipment	Compact controller DCCa
Measuring principle, technology	Inductive, 2 coils. Integrated temperature measurement

Order no.
on request

ICT 5-IMA

P_DT_0079_SW



1.4 DULCOTEST® Conductivity Sensors



Conductivity Sensor ICT 2

High-performance inductive conductivity sensor with high dynamic measuring range. Also suitable for types of water with aggressive chemicals and film-forming components. Permitted temperatures up to 125 °C. For installation in pipework, tanks and for immersion in storage tanks

Your benefits

- Measured variable: electrolytic conductivity. The inductive (non-contact) measuring principle permits applications in chemically contaminated types of water and in film-forming media
- There is no need for adhesive or seals as the sensor is fully embedded in PFA
- Measurements at high conductivity values of up to 2,000 mS/cm are possible without interfering polarisation by means of the high measuring range dynamics of the inductive measuring principle
- Flexible connection to the processes is possible via a flange or immersion pipe with optional accessories

Measuring range	0.02...2,000 mS/cm
Cell constant k	1.98 cm ⁻¹
Measuring accuracy	± (5 µS/cm + 0.5% of the measured value) at T < 100 °C ± (10 µS/cm + 0.5% of the measured value) at T > 100 °C
Temperature compensation	Pt 100, class A, completely extrusion-coated
Process chemical temperature	0...125 °C for use together with D1C, temperature compensation is limited to 100 °C
Max. pressure	16.0 bar
Material	PFA, completely extrusion-coated
Electrical connection	5 m fixed cable
Enclosure rating	IP 67
Typical applications	Production processes in the chemical industry, phase separation of product mixtures, determination of concentrations of aggressive chemicals.
Resistance to	Electrolytic conductivity > 20 mS/cm, PFA-compatible aggressive chemicals, deposit-forming media
Installation	Fitting in pipes, tanks (sideways): G 3/4 stainless steel thread (1.4571) or flange fitting: With the accessories: Stainless steel flange ANSI 2 inch 300 lbs, SS 316L (adaptable to DIN counter flange DN 50 PN 16).
Measuring and control equipment	D1C
Measuring principle, technology	Inductive, 2 coils. Integrated temperature measurement

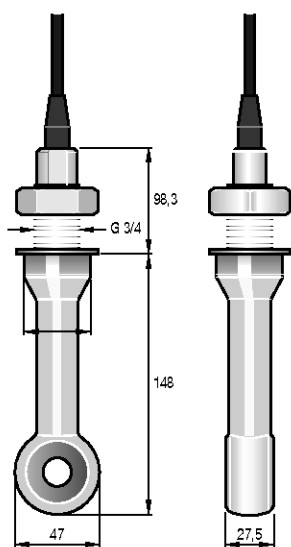

pk_6_082

Installation kit for type ICT 2 sensors → 1-133

	Order no.
ICT 2	1023352



1.5 Turbidity Measuring Points DULCOTEST®

1.5.1 Turbidity Measuring Point DULCOTEST® DULCO® turb C

**Reliable on-line measurement of turbidity with DULCOTEST® DULCO® turb C measuring points
Measuring range 0 – 1,000 NTU**



Turbidity measurements with DULCOTEST® DULCO® turb C: Compact measuring instrument that uses light scatter to measure turbidity, with a large measuring range and different designs to comply with ISO and EPA standards. Available with or without automatic cleaning.

The DULCOTEST® measuring points for turbidity in the DULCO® turb C range with versions TUC 1, TUC 2, TUC 3 and TUC 4, are compact online turbidity measuring points, consisting of a sensor, inline flow fitting and measuring device. The measuring device permits the measured value to be displayed, calibration, transmission of the measured value via a 4-20 mA signal and the indication of limit value transgressions and device faults. The measuring cuvette integrated in the measuring device enable the device to operate in the bypass of the process line. The visual measuring unit does not come into contact with the sample medium.

The intended application is the treatment of potable water, with the DULCO® turb C able to be used in all treatment stages of raw water, from filter monitoring to measurement of fine turbidity in dispensed potable water. It is also possible to monitor the turbidity of slightly contaminated process water and waste water, as well as treated water from the food and beverage industry up to a turbidity value of 1,000 NTU. Compared with the TUC 1/TUC 2, the TUC 3 / TUC 4 measuring stations include an ultrasound-based self-cleaning function. This helps in particular to extend the service intervals particularly when used with the types of water that form films.

The measuring principle is identical to light scatter measurements. The light beam that is beamed into the measuring cuvette filled with sample water is dispersed on turbidity particles and the scattered light is measured at right angles (90°) to the beamed in light (Nephelometric measurement). The measuring unit for the turbidity measurement can be given as NTU (Nephelometric Turbidity Unit) or as FNU (Formazin Nephelometric Unit). The measuring process of types TUC 1/TUC 3 (infrared light) corresponds to the globally applicable standard ISO 7027 and the European Standard DIN EN 27027. The measuring process of types TUC 2/TUC 4 (white light) corresponds to the US American standard USEPA 180.1.

Your benefits

- Compact turbidity measuring station with integrated sensor, flow cuvette and measuring instrument saves space and is simple to install and operate.
- High dynamic measuring range between 0.02 and 1,000 NTU permits broad-based use in all stages of potable water treatment. Also ideal for monitoring waste water from clarification plants and for monitoring ruptures with filters.
- Short response times thanks to small-volume measuring cuvette.
- Long-term stable measurements, even in contaminated water, by the optional ultrasonic cleaning of the measuring cuvette.
- Fast and simple calibration on site by optionally available, pre-assembled and time-stable calibration standards.

Technical Details

- The measuring process in types TUC 1/TUC 3 (infrared light) corresponds to the global standard ISO 7027 and the European standard DIN EN 27027.
- The measuring process in types TUC 2/TUC 4 (white light) corresponds to the US standard USEPA 180.1.

Field of application

- Potable water treatment, for all treatment steps: from raw water and filter monitoring to measuring fine turbidity in the potable water that is to be discharged
- Monitoring of turbidity in slightly polluted industrial water, waste water and water requiring treatment in the food and beverage industry up to a turbidity value of 1,000 NTU

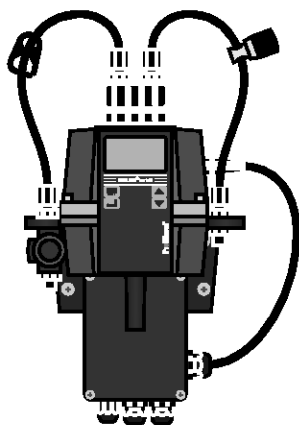

P_DMZ_0002_SW



1.5 Turbidity Measuring Points DULCOTEST®

1

Technical Data

Measurement range	0 ... 1,000 NTU
Accuracy	± 2% of the displayed value or ± 0.02 NTU below 40 NTU, depending on which value is the greater ± 5% of the displayed value above 40 NTU
Resolution	0.0001 NTU below 10 NTU
Response time	Configurable
Display	Multiple row LCD display with background lighting
Alarm relay	Two programmable alarms, 120-240 VAC, 2 A Form C relay
Output signal	4 ... 20 mA, 600 Ω, not electrically isolated: dual-isolated, degree of interference, overvoltage category II
Communication interface	Bi-directional RS-485, Modbus
Max. pressure	Integrated pressure regulating valve regulates 1380 kPa (200 psi), based on the flow rate
Flow	6 – 60 l/h
Temperature	1 ... 50 °C
Materials in contact with the medium	Polyamide (PA), silicone, polypropylene (PP), stainless steel, borosilicate glass
Voltage supply	100 – 240 VAC, 47 – 63 Hz, 80 VA
Hydraulic connector	Black tube, inside 4.75 mm, outside 8 mm
Ambient conditions	Not suitable for operation outdoors. Maximum operating altitude 2000 m above sea level. Maximum 95% relative air humidity (non-condensing).
Enclosure rating	IP 66, NEMA 4x
Standard	ISO 7027 or DIN EN 27027 with the "Infrared" version, USEPA 180.1 with the "Achromatic light" version
Dimensions H x W x D	35 x 30 x 30 cm
Shipping weight	2.5 kg

	Standard	Ultrasonic cleaning	Order no.
TUC 1	Infrared light: ISO 7027, DIN EN 27027	No	1037696
TUC 2	White light: US EPA 180.1	No	1037695
TUC 3	Infrared light: ISO 7027, DIN EN 27027	Yes	1037698
TUC 4	White light: US EPA 180.1	Yes	1037697

Spare Parts

	Order no.
Drying agent	1037701
TUC 1/TUC 2 cuvette (set with 3 no.)	1037877
Cuvette TUC 3 / TUC 4	1037878
Infrared lamp TUC 1 / TUC 3	1037702
Achromatic light lamp TUC 2 / TUC 4	1037703
Hose kit	1037879
Pressure regulating valve	1037885

Accessories

	Order no.
Calibration set	1037699
Flow control	1037880
Air bubble trap	1037700



1.6 Accessories Sensor Technology

1.6.1 Sensor Accessories

General guidelines:

- Ensure that signal leads are as short as possible.
- Ensure signal leads are separated from power cables running parallel to them.
- Use pre-assembled combined signal leads wherever possible.

Measuring Lines for pH and ORP Measurement

- Pre-assembled to facilitate installation
- Factory tested to ensure function reliability
- IP 65

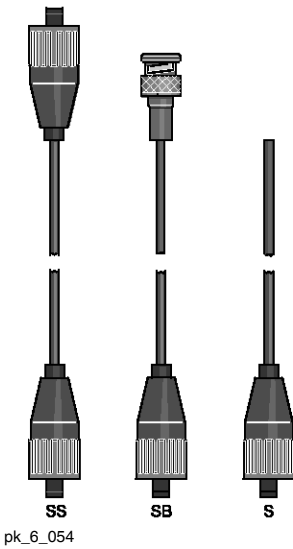

pk_6_054

Type	Description	Order no.
2 x SN6	Coaxial cable, Ø 5 mm, 0.8 m – SS	305077
2 x SN6	Coaxial cable, Ø 5 mm, 2 m – SS	304955
2 x SN6	Coaxial cable, Ø 5 mm, 5 m – SS	304956
2 x SN6	Coaxial cable Ø 5 mm, 10.0 m - SS	304957
SN6 - open end	Cable combination, coaxial, Ø 5 mm 0.8 m - SN6 - pre-assembled	1024105
SN6 - open end	Cable combination, coaxial, Ø 5 mm 2 m - SN6 - pre-assembled	1024106
SN6 - open end	Cable combination, coaxial, Ø 5 mm 5 m - SN6 - pre-assembled	1024107
SN6 - open end	Coaxial cable, Ø 5 mm, 10.0 m	305040
SN6 - BNC	Coaxial cable Ø 3 mm, 10.0 m - SB	305099
SN6 - BNC	Coaxial cable Ø 3 mm, 0.8 m – SN6/BNC	1033988
SN6 - BNC	Coaxial cable, Ø 3 mm, 2.0 m – SB	1033011
SN6 - DIN	Coaxial cable Ø 5 mm, 0.8 m - SD	305098
SN6 - DIN	Coaxial cable Ø 5 mm, 2.0 m - SD	304810
SN6 - open end d5 (DSR)	Cable combination coax 2.0 m - S	1005672

Measuring Line for Sensors with Vario Pin Plug-In Heads

Ready-made 6-conductor measuring line with Vario Pin plug for connection to sensor type PHEPT 112 VE.

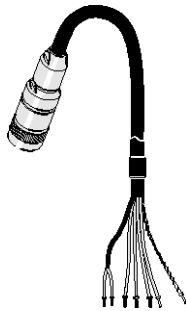

pk_6_069

	Length m	Order no.
Vario Pin signal lead VP 6-ST/ 2 m	2	1004694
Vario Pin signal lead VP 6-ST/ 5 m	5	1004695
Vario Pin signal lead VP 6-ST/10 m	10	1004696

SN6 Coax Connector

K 74 crimping pliers and a soldering iron are required for connecting coax connectors to cables.

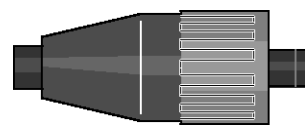

pk_6_056

	Order no.
SN6 coaxial plug for 5 mm Ø coaxial signal lead	304974
SN6 coaxial plug for 3 mm Ø coaxial signal lead	304975

LK Coaxial Signal Cable

For pH and ORP measurements.



pk_6_055

	Order no.
Coax low noise Ø 5 mm, black	723717
Coax low noise Ø 3 mm, black	723718

Please specify length with order.



1.6 Accessories Sensor Technology

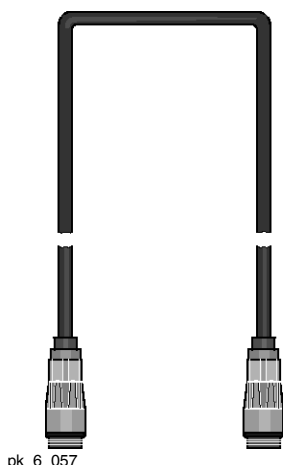

pk_6_057

Measuring lines for 4P type chlorine sensors

The measuring line is necessary for the connection of -4P sensors to the measuring/control device D_4a.

- Simple installation, as no self-assembly is required
- High operational safety due to factory functional testing
- IP 65

	Length m	Order no.
Measuring line for 4P type chlorine sensors	2	818455
Measuring line for 4P type chlorine sensors	5	818456
Measuring line for 4P type chlorine sensors	10	818470



pk_1_085

Measuring Lines for DMT Type Chlorine Sensors

The measuring line is needed for connection of DMT type sensors to the DMT transducer.

	Length m	Order no.
Universal cable, 5-pin round plug	2	1001300
Universal cable, 5-pin round plug	5	1001301
Universal cable, 5-pin round plug	10	1001302

Cabling Accessories for CAN Type Chlorine Sensors

	Order no.
T-distributor M12 5 pole CAN	1022155
Termination resistor M12 coupling	1022154
Termination resistor M12 plug	1022592
Connecting cable - CAN M12 5-pole 0.5 m	1022137
Connecting cable - CAN M12 5-pole 1 m	1022139
Connecting cable - CAN M12 5-pole 2 m	1022140
Connecting cable - CAN M12 5-pole 5 m	1022141
Connecting cable - CAN, sold by the metre	1022160
Plug-CAN M12 5-pole screw terminal	1022156
Coupling-CAN M12 5-pole screw terminal	1022157

Measuring Lines for Pt 100 and Pt 1000

Measuring line: 2-core, conductor: 0.5 mm².

	Length m	Order no.
SN6 - open-ended	5	1003208
SN6 - open-ended	10	1003209
SN6 - open-ended	20	1003210

Measuring Line for Conductive Conductivity Sensors

4-core, conductor: 0.25 mm², cable diameter: 5.7 mm, screened

Type	Length m	Order no.
Measuring line for conductive conductivity sensors	1	1046024
	3	1046025
	5	1046026
	10	1046027



1.6 Accessories Sensor Technology

2-Wire Measuring Line

2-core, conductor: 0.25 mm², cable diameter: 4 mm

For amperometric sensors and transformers, each with 4-20 mA output.

	Order no.
Two-wire measuring line 2 x 0.25 mm ² Ø 4 mm	725122

Connector cable

For fluid voltage comparison in-line probe housing DLG III, DLG IV and DGMA with connector, 5 m.

	Length m	Order no.
Connector cable	5	818438

Test and Calibration Kit for Inductive Conductivity

	Order no.
Test and calibration kit	1026958



1.6 Accessories Sensor Technology

1.6.2 Consumable Items for Sensors

1

pH Quality Buffer Solutions

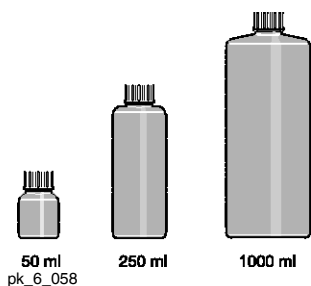

Accuracy \pm pH 0.02 (\pm 0.05 at pH 10). The shelf life depends upon frequency of use and the amount of chemical drag-in.

Alkaline buffer solutions can react with CO₂ if left open. This will affect their values, therefore close after use. Buffer solutions should be replaced a maximum of three months after opening. The solution contains a biocide to prevent bacteria forming.

	Capacity ml	Order no.
Buffer pH 4.0 – red	50	506251
Buffer pH 4.0 – red	250	791436
Buffer pH 4.0 – red	1,000	506256
Buffer pH 5.0 – red	50	506252
Buffer pH 7.0 – green	50	506253
Buffer pH 7.0 – green	250	791437
Buffer pH 7.0 – green	1,000	506258
Buffer pH 9.0 – colourless	50	506254
Buffer pH 9.0 – colourless	1,000	506259
Buffer pH 10.0 – blue	50	506255
Buffer pH 10.0 – blue	250	791438
Buffer pH 10.0 – blue	1,000	506260

ORP Quality Buffer Solutions

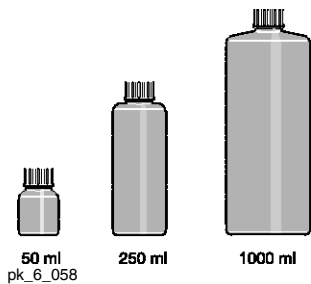

Accuracy to \pm 5 mV. Shelf life depends upon frequency of use and the strength of the chemicals in sample solutions.

Buffer solutions should be replaced a maximum of three months after opening.

Warning: The 465 mV ORP buffer solution is an irritant!

	Capacity ml	Order no.
ORP buffer 465 mV	50	506240
ORP buffer 465 mV	250	791439
ORP buffer 465 mV	1,000	506241
ORP buffer 220 mV	50	506244
ORP buffer 220 mV	1,000	506245

DPD-reagents for calibration of amperometric sensors s. p. → 2-95

3 Molar KCl Solutions

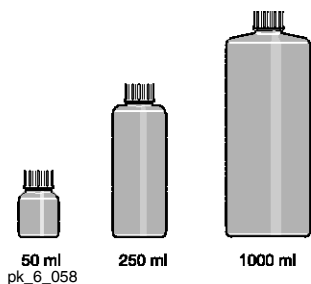

3-molar KCl solution is most suited for the storage of pH and ORP sensors (e.g. in sensor quills) and as an electrolyte for refillable sensors (e.g. PHEN, RHEN). We only recommend using the KCl solution saturated with AgCl for the old design of refillable sensors with reference electrodes without a large AgCl reservoir.

	Capacity ml	Order no.
KCl solution, 3 molar	50	505533
KCl solution, 3 molar	250	791440
KCl solution, 3 molar	1,000	791441
KCl solution, 3 molar, AgCl saturated	250	791442
KCl solution, 3 molar, AgCl saturated	1,000	505534





1.6 Accessories Sensor Technology

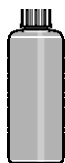

250 ml

pk_6_058_2

Cleaning Solutions

Cleaning solution pepsin/hydrochloric acid:
for cleaning pH sensors, the membranes of which have been contaminated with protein.

Capacity	Order no.
250 ml	791443

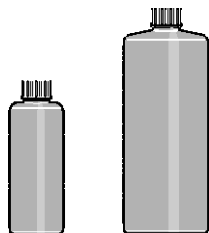

250 ml

1000 ml

pk_6_058_3

Conductivity Calibration Solution

For the precise calibration of conductivity sensors.

	Capacity ml	Order no.
Conductivity calibration 1413 $\mu\text{S/cm}$	250	1027655
Conductivity calibration 1413 $\mu\text{S/cm}$	1,000	1027656
Conductivity calibration 12.88 mS/cm	250	1027657
Conductivity calibration 12.88 mS/cm	1,000	1027658



pk_6_061

Electrolyte for Amperometric Sensors

	Capacity ml	Order no.
Electrolyte for all chlorine sensors type CLE, CLR 1	100	506270
Electrolyte for CDM 1 and CDE 3 type chlorine dioxide sensors	100	506271
Electrolyte for CDE 2 and CDR 1 type chlorine dioxide sensors	100	506272
Electrolyte for OZE type ozone sensors	100	506273
Electrolyte for CGE/CTE/BRE type sensors	50	792892
Electrolyte for CDP type chlorine dioxide sensors	100	1002712
Electrolyte for peracetic acid sensors type PAA 1, OZR 1	100	1023896
Electrolyte for CLT 1 type chlorite sensors	50	1022015
Electrolyte for PER 1 type hydrogen peroxide sensors	50	1025774
Electrolyte for CLO 1 type chlorine sensor	100	1035191
Electrolyte for CLO 2 type chlorine sensor	100	1035480
Electrolyte for CBR 1 type chlorine/bromine sensor	100	1038017
Electrolyte for BCR 1 type bromine sensor	50	1044843

1.6 Accessories Sensor Technology

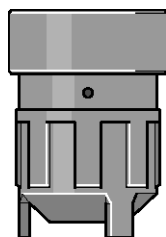

pk_6_075

Spare Membrane Caps, Accessory Sets for Amperometric Sensors

	Capacity ml	Order no.
Membrane cap for types CLE II T, CDM 1 and OZE 1	-	790486
Membrane cap for types: CLE 2.2, CLE 3, CDE 1.2, CDE 2, OZE 2 and OZE 3	-	790488
Sensor cap for CLO 1	-	1035197
Sensor cap for CLO 2	-	1035198
Membrane cap for CGE/CTE 1 (2/5/10 ppm) and BRE 1 (10 ppm), BRE 2	-	792862
Membrane cap for CTE 1 (0.5 ppm), CBR 1, BCR 1	-	741274
Membrane cap for CDP 1, BRE 1 (0.5 / 2 ppm), CLT	-	1002710
Membrane cap for CDE 3	-	1026578
Diaphragm cap for PAA 1, CDR 1, CLR 1, OZR 1	-	1023895
Membrane cap for PER 1	-	1025776
Membrane cap for H2.10 P	-	792978
Accessory set for CGE 2/CTE 1 (2/5/10 ppm) and BRE 1 (10 ppm), BRE 2 (2 membrane caps + electrolyte)	50	740048
Accessory set for CTE 1 (0.5 ppm) (2 membrane caps + electrolyte)	50	741277
Accessory set for CLE (2 membrane caps + electrolyte)	100	1024611
Accessory set for CDP 1 (2 membrane caps + electrolyte), BRE 1 (0.5 / 2 ppm), CLT	100	1002744
Accessory set for PAA 1 and OZR 1 (2 diaphragm caps + electrolyte)	100	1024022
Accessory kit for PER 1 (2 membrane cap + electrolyte)	50	1025881
Accessory set for CDE 3 (2 membrane caps + electrolyte)	100	1026361
Accessory set for CLO 1 (electrolyte, grinding disc, plug)	100	1035482
Accessory set for CLO 2 (electrolyte, grinding disc, plug)	100	1035483
Accessory set for CBR 1 (2 membrane caps + electrolyte)	100	1038984
Accessory set BCR 1 (2 membrane caps + electrolyte)	50	1044844

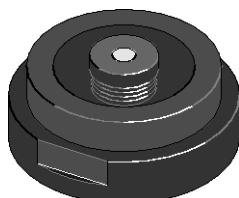

pk_6_062

Spare Parts for Dissolved Oxygen Sensors

	Measuring range	Order no.
Sensor insert for DO 1-mA-20 ppm: Membrane thickness 125 µm	2.00...20.0 mg/l	1020534
Sensor insert for DO 2-mA-10 ppm: Membrane thickness 50 µm	0.10...10.0 mg/l	1020535
Bracket for the sensor insert for DO 1-mA-20 ppm (with membrane protection for fish farming)		1020540
Bracket for the sensor insert for DO 2-mA-10 ppm		1020541



1.6 Accessories Sensor Technology

1.6.3 Bypass Fittings for Sensors

DLG III Type In-Line Probe Housing

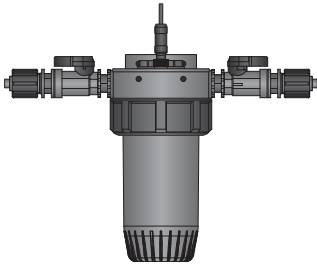

P_DTZ_0030_SW

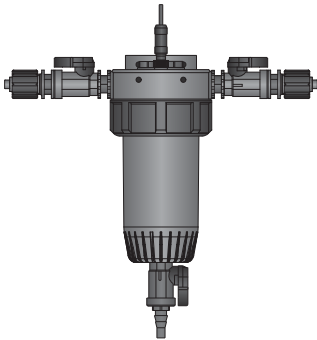

P_DTZ_0031_SW

To hold 2 sensors (conductivity, Pt 100, pH or ORP sensors) with PG 13.5 screw-in thread plus one sensor with R 1" screw-in thread (amperometric sensors) with integrated stainless steel pin as liquid reference potential.

On the inlet side the DLG III is equipped with a plastic ball valve for blocking and adjusting the sample water flow.

Material Material: Rigid PVC
Transparent housing cup: Polyamide
Ball valve material: Rigid PVC

Max. pressure 1.0 bar

Max. temperature 55 °C

Typical applications Cooling water, slightly contaminated waste water, turbid water, no sludge

Type	Max. temperature °C	Order no.
DLG III A with PVC hose connectors	for PE line Ø 8/5 mm	55 914955
DLG III A with flushing connector and PVC hose connection	for PE line Ø 8/5 mm	55 1029096
DLG III B with PVC adhesive connectors	for pipe connection Ø 16 DN 10	55 914956
Assembly kit for fitting amperometric sensors	–	55 815079

DLG IV Type In-Line Probe Housing

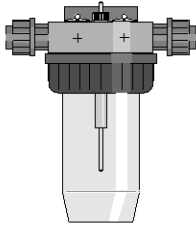

pk_6_070

To hold 4 sensors (pH, ORP, Pt 100, conductivity) with PG 13.5 screw-in thread. With integrated stainless steel rod as liquid reference potential. Angle for wall mounting.

Material Material: Hard PVC or PP
Transparent housing cup: Polyamide

Max. pressure 1.0 bar

Connection for sample water line Union with d 16/DN 10 insert

Type	Max. temperature °C	Order no.
DLG IV PP	for Ø 16/DN 10 pipe work connector	80 1005331
DLG IV PVC	for Ø 16/DN 10 pipe work connector	55 1005332

DLG Sampling Water Cup

Order no.
DLG III sampling water cup with back flush device



1.6 Accessories Sensor Technology

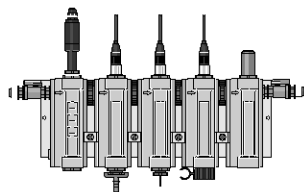

pk_6_066

DGM Modular In-Line Probe Housing

To hold conductivity, Pt 100, pH or ORP sensors with PG 13.5 screw-in thread or amperometric sensors with R 1" screw-in thread.

Advantages:

- Simple installation (completely ready-mounted on a panel); max. 7 modules on a panel
- Simple retrofit extension option (see extension modules)
- Module for sample water flow control
- Quick measurement recording due to low volume of sample water
- Each completely assembled DGM is equipped with a simple sampling tap

Ball valves on both sides for shutting off the flow and for flow adjustment

Material	All modules: Transparent PVC Seals: FKM Calibration cup: PP Mounting panel: PVC white
Max. temperature	60 °C
Max. pressure	6.0 bar up to 30 °C, 1.0 bar up to 60 °C
Max. flow rate	80 l/h
Recommended Flow volume	40 l/h
Flow sensor	Reed contact Max. switch power 3 W Max. switch voltage 175 V Max. switch current 0.25 A Max. operating current 1.2 A Max. contact resistance 150 mΩ
Switching hysteresis	20%
Enclosure rating	IP 65
Typical applications	Potable water, swimming pool water or water of similar quality with no suspended solids
Assembly	Max. 5 modules pre-assembled onto baseboard: more than 5 modules, pre-assembled onto baseboard as custom version, priced accordingly.

FKM = Fluorine Rubber

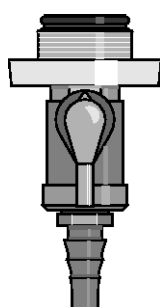

pk_6_071

Sampling Tap for DGM

For PG 13.5 and 25 mm modules designed as a convenient ball valve.

	Order no.
PG 13.5 sampling tap	1004737
25 mm sampling tap	1004739

Expansion Modules for DGM

For simple retrofit to an existing DGM.

	Order no.
Flow expansion module with scale in l/h	1023923
Flow expansion module with scale in gph	1023973
Flow sensor for flow expansion module (optional)	791635
Expansion module for PG 13.5 sensors	1023975
Expansion module for 25 mm sensors	1023976

Connecting Lead

For fluid voltage comparison in-line probe housing DLG III, DLG IV and DGMA with connector, 5 m.

	Order no.
Connector cable	818438



1.6 Accessories Sensor Technology

Isolation Ball Valve for DGM

To isolate the bypass from the process flow

	Order no.
Stopcock	1010380

Mounting Kit for Sensor/DGM

For mounting amperometric sensors with R 10 connection

	Order no.
Mounting kit for sensor/DGM	791818

Identity Code Ordering System for In-Line Probe Housing Modules

DGM	Series	Series Version
	A	
		Flow monitor module
		1 with l/h scale
		2 with gph scale (US)
		3 With flow monitor, l/h scale
		4 with flow monitor, gph scale (US)
		Number of PG 13.5 modules
		0 without PG 13.5 modules
		1 one PG 13.5 module
		2 two PG 13.5 modules
		3 three PG 13.5 modules
		4 four PG 13.5 modules
		Number of 25 mm modules
		0 No 25 mm modules
		1 One 25 mm module
		2 Two 25 mm modules
		Main material
		T Transparent PVC
		Sealing material
		0 FKM A
		Hydraulic connectors
		0 8 x 5 hose
		1 PVC DN 10 threaded connector
		4 Hose 12 x 6
		Version
		0 With ProMinent® logo
		1 Without ProMinent® logo
		2 With ProMinent® logo, without mounting plate
		3 Without ProMinent® logo, without mounting plate

Accessories supplied:

- Wall fastenings for PG 13.5 modules: Calibration plate, mounting kits for PG 13.5 probes

The identity code DGM A 3 2 1 T 0 0 0 describes, for example, a fully assembled configuration of a flow module with sensor, two PG 13.5 modules (e.g. for pH and ORP probes) and a 25 mm module (e.g. for CLE 3 chlorine sensor) 8 x 5 tube connectors are ready mounted.

Recommended Accessories

	Order no.
for potential equalizer plug	791663
Flow sensor for flow expansion module (optional)	791635
additional calibration cup	791229
PG 13.5 sampling tap	for 13.5 module 1004737
25 mm sampling tap	for 25 mm module 1004739

- Max. 7 modules possible on a mounting plate
- More on request

FKM = Fluorine Rubber



1.6 Accessories Sensor Technology

1.6.4 Immersion Fittings for Sensors

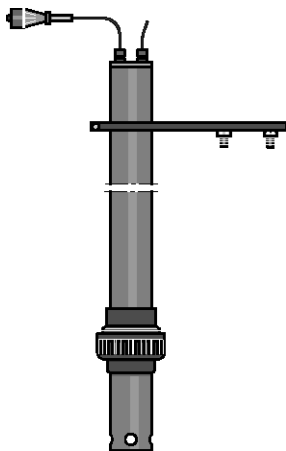

pk_6_064

PVC Immersion Assembly Type ETS 1 P

Immersion fitting to hold **one** conductivity, Pt 100, pH or ORP sensor with SN6 plug-in head and PG 13.5 screw-in thread. In addition, a stainless steel rod is integrated as a liquid reference potential.

Sensor connector (inner)	SN6 connector
Signal lead connector (outer)	Coax SN6 male connector
Material	Rigid PVC
Type of fitting	Clamping flange with mounting plate
Immersion depth	Variable
Max. temperature	55 °C

	Order no.
ETS 1 P	914950

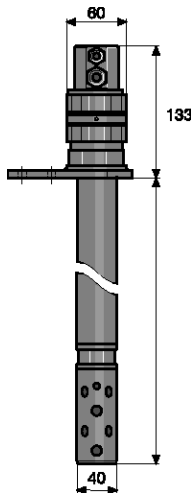

pk_6_080

PP Immersion Assembly Type IPHa 1-PP

Immersion fitting for holding **one** sensor (e.g. pH, ORP) with PG 13.5 screw-in thread and standard 120 mm length. The inside diameter is sized so that either pH or ORP transducers can be installed. In addition, a stainless steel rod is integrated as a liquid reference potential. The outside diameter is 40 mm. Immersion depths of 1 and 2 m are offered, however customers can independently lengthen or shorten the immersion pipe. The fitting head contains two cable connectors; measuring lines of 3-7 mm diameter can be led out.

Note: Measuring lines are not included in the scope of delivery.

Material	Probe housing material: PP Seal material: FKM
Max. temperature	80 °C
Pressure	Installation at atmospheric pressure
Immersion depth	Max. 1, or 2 m; variable
Immersion lance diameter	40 mm

Dimensions Table: Flange

Fixed flange	DN 40
Hole circle Ø K	110 mm
Bolts	4 x M16
Thickness d ₂	18 mm
Diameter Ø D	150 mm

	Length when fitted m	Order no.
IPHa 1-PP	1	1008600
IPHa 1-PP	2	1008601

Other materials available on request.

FKM = Fluorine Rubber

Accessories for Fitting Type IPHa 1

	Order no.
Immersion pipe mounting for IPHa 1-PP	1008624
Clamped threaded connector with fixed flange DN 40 according to DIN 2642 for IPHa 1-PP	1008626
Clamped threaded connector for welding connection for IPHa 1-PP	1008628
Protective (weatherproofed) cover for assembly head for IPHa 1-PP	1008630
Water-retaining basin for IPHa 1-PP	1008632
Weatherproof cover PP	1023368



1.6 Accessories Sensor Technology

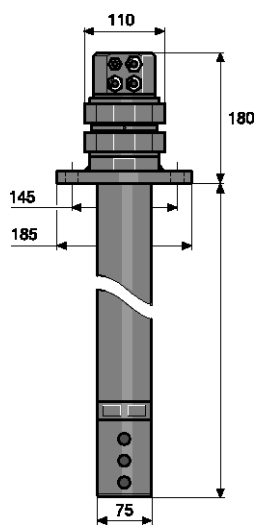

pk_6_081

PP Immersion Assembly Type IPHa 3 -PP

To hold up to **three** sensors (e.g. pH, ORP, temperature) with PG 13.5 screw-in thread and standard 120 mm length. The inside diameter is dimensioned so that up to three pH, ORP or temperature transducers can be installed. In addition a stainless steel rod is incorporated as a liquid reference potential. The outside diameter is 75 mm. Immersion depths of 1 and 2 m are offered, however, customers can independently lengthen or shorten the immersion pipe. The fitting head contains four cable connectors, measuring lines of 3-7 mm diameter can be led out. Measuring lines are not contained in the scope of supply. Technical data is as for fitting IPHa 1, except the immersion tube diameter is 75 mm.

Material	Probe housing material: PP Seal material: FKM
Max. temperature	80 °C
Pressure	Installation at atmospheric pressure
Immersion depth	Max. 1, or 2 m; variable
Immersion lance diameter	75 mm

Dimensions Table: Flange

Fixed flange	DN 65
Hole circle Ø K	145 mm
Screws	4 x M16
Thickness d ₂	18 mm
Diameter Ø D	185 mm

	Length when fitted m	Order no.
IPHa 3-PP	1	1008602
IPHa 3-PP	2	1008603

Other materials available on request.

FKM = Fluorine Rubber

Accessories for Fitting Type IPHa 3

	Order no.
Immersion pipe mounting for IPHa 3-PP	1008625
Clamped threaded connector with fixed flange DN 65 according to DIN 2642 for IPHa 3-PP	1008627
Clamped threaded connector for welding connection for IPHa 3-PP	1008629
Protective (weatherproofed) cover for assembly head for IPHa 3-PP	1008631
Water-retaining basin for IPHa 3-PP	1008633
Weatherproof cover PP	1023368

Weatherproof cover for in-line probe fitting type IMA-ICT 1

For use in immersion assembly, type IMA-ICT 1.

	Order no.
Weatherproof cover PP	1023368



1.6 Accessories Sensor Technology

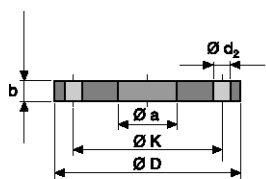

Immersion Assembly Type IMA-ICT 2

To hold one inductive conductivity sensor of type ICT 2.

Material	Fittings: Stainless steel 1.4404 Seal: FKM
Max. temperature	125 °C
Max. pressure	10 bar
Length when fitted	1 m
Immersion lance diameter	70 mm
Flange	Stainless steel flange DN 80 PN 16

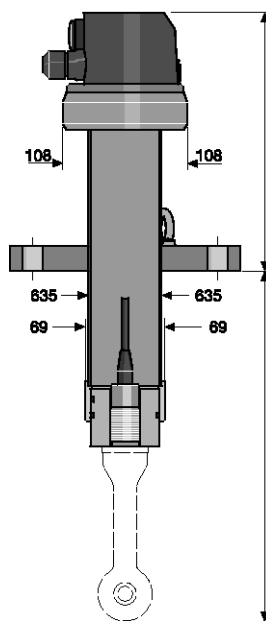

Dimensions Table: Flange

Flange	DN 65/PN 16
Ø D	200 mm
Ø K	160 mm
Ø d ₂	8 x 18 mm
b	20 mm
Ø a	63.5 mm
Screws	M 16

Order no.

IMA-ICT 2	1023353
------------------	---------

Adaptation to processes through flange installation in tank from top.

pk_6_094



1.6 Accessories Sensor Technology

Immersion assembly type TA-LM

To hold **one** conductivity sensor of type LM and LMP with M 28 thread for side fastening with pipe clips (2 contained in the scope of supply) or with union nut/collar bush/screw-in part for fastening in a tank cover. Union nut and screw-in part are to supplied by the customer (standard parts).

Material	PP
Max. temperature	70 °C
Enclosure rating	IP 68
Max. pressure	5.0
Immersion lance diameter	32 mm
Pipe length	890

	Length mm	Order no.
TA-LM	890	1020632
Headed bush d50	-	1020634
Extension tube 1000	910	1020633

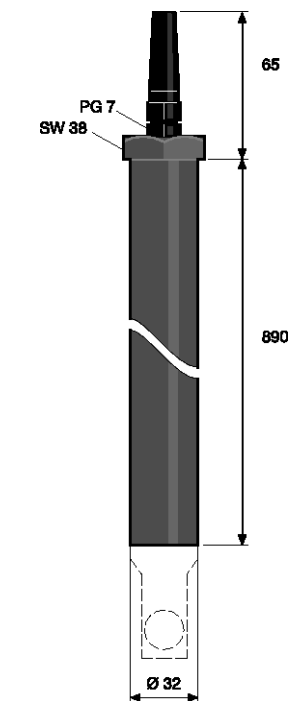

pk_6_053

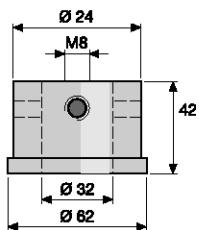
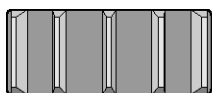

pk_6_078

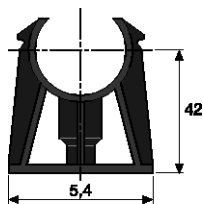

pk_6_079

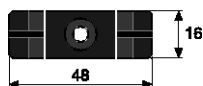

1.6 Accessories Sensor Technology

1.6.5 Installation Fittings / Adapters

Adapter set (T-piece and adapter)

For direct fitting of conductivity, Pt 100, pH or ORP sensors with PG 13.5 screw-in pipework:

	Material	Order no.
90° T-piece DN 20	PVC	1001493
90° T-piece DN 25	PVC	1001494
45° T-piece DN 20	PVC	1001491
45° T-piece DN 25	PVC	1001492

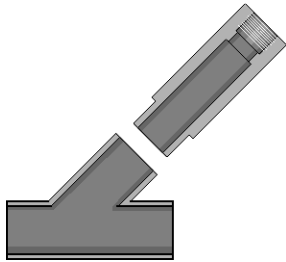

pk_6_059

PVC adapter set for type LM sensors

For direct fitting of type LM conductivity sensors with 3/4" screw-in thread for measuring in the flow.

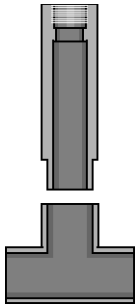

pk_6_060

For LM(P) 001 conductivity sensors

The sensors are fitted in the straight section of the T-piece.

	Material	Order no.
90° T-joint DN 25	PVC	356410
Adapter DN 25 with 3/4" thread	PVC	356923
90° T-joint DN 25	PP	358674
Adapter with 3/4" thread	PP	356953

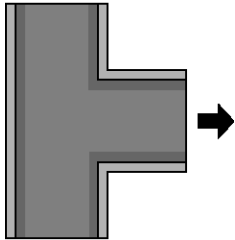
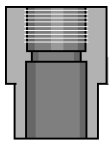

pk_6_090_2

For LM(P) 01 conductivity sensors

The sensors are fitted in the outlet of the T-piece.

	Material	Order no.
90° T-piece DN 20 - 3/4"	PVC	356455
90° T-piece DN 20 - 3/4"	PP	356471

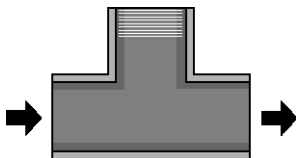

pk_6_091_2

For LM(P) 1 conductivity sensors

The sensors are fitted in the outlet of the T-piece.

	Material	Order no.
90° T-joint DN 25	PVC	356410
Inline fitting DN 25 - 3/4"	PVC	1020616

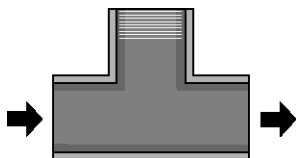
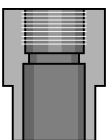

pk_6_092



1.6 Accessories Sensor Technology

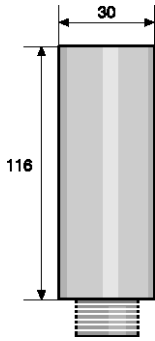

pk_6_065

Adapter PP, PG 13.5

For direct fitting of conductivity, Pt 100, pH or ORP sensors with PG 13.5 screw-in thread in, for example, pipework, tanks:

Max. temp: 80 °C (at atmospheric pressure)

EPDM sealing ring

	Material	Outer thread	Order no.
Adapter DN 20	PP	R 1/2"	1001834
Adapter DN 25	PP	R 3/4"	1001835

Adapter, stainless steel, PG 13.5

For direct fitting of conductivity, Pt 100, pH or ORP sensors with PG 13.5 screw-in thread in, for example, pipework, tanks:

Max. temp: 180 °C (at atmospheric pressure)

Sealing ring, FKM (fluorine rubber)

	Material	Outer thread	Order no.
Adapter DN 20	SS	R 1/2"	1020737
Adapter DN 25	SS	R 3/4"	1020738

Installation kit for type ICT 2 sensors

For direct fitting of the inductive conductivity sensor ICT 2 in pipework and tanks.

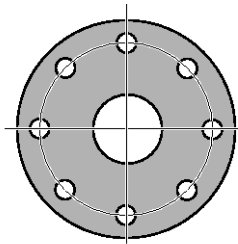

pk_6_093

	Order no.
Installation kit for type ICT 2 sensors	1023364

Kit consisting of

- Stainless steel flange ANSI 2 inch 300 lbs, SS 316L (adaptable to DIN counter flange DN 50 PN 16)
- Nut 3/4" stainless steel

Parts that come into contact with the medium:

- Sealing disk, "2", / PTFE
- Spacer ring, PTFE
- Seal

Fixed flange	ANSI 2"	DN 50
SS 316L	300 lbs	PN 16
Pitch circle	127	125
Screws	M 16	M 16
Thickness	22.2	18
Diameter	165.1	165

Welding socket for T-piece (PP) type ICT 1

For connection of the inductive conductivity sensor ICT 1 in PP T-piece.

	Order no.
Welding socket G 2 1/4 inch DN40 PP incl. O-ring FKM	1023371



1.6 Accessories Sensor Technology

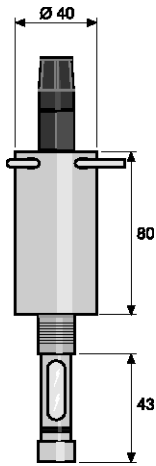

pk_6_013

Retractable sensor housing for pH, ORP sensors WA-PH 1

To hold **one** pH sensor with PG 13.5 screw-in thread and length of between 110-125 mm for fitting in the storage tank or in the flow. The sensor can be removed and fitted for calibration and cleaning without draining the liquid from the storage tank or without interrupting the process in the flow.

Material	PP
Max. temperature	70 °C
Max. pressure	5.0 bar
Thread	3/4"

	Order no.
WA-PH 1	1020631

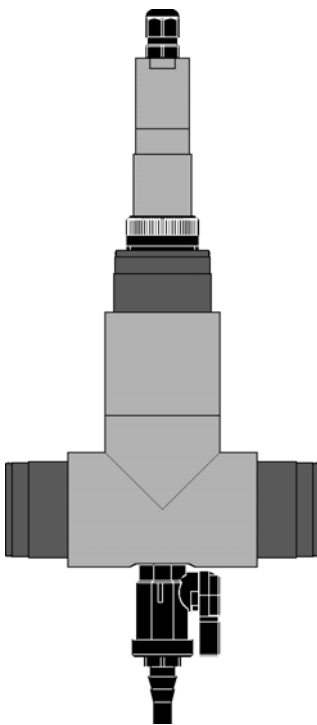

pk_6_110

Installation fitting INLI for chlorine sensor CLO

The installation valve permits the installation of the sensor for free chlorine types CLO (part no. 1033870, 1033871, 1033878) and the sensor for conductivity type CCT 1-mA (order no. 1081545) for operation in the process line (G 1") or in the bypass to the process line. Use either with a free outlet or return of the sample water to the process line. Sample water temperature up to 70 °C/2 bar and 40 °C/7 bar. Keep the flow constant.

Max. temperature	70 °C (at 2 bar)
Max. pressure	7 bar (at 40 °C)
Flow for operation of the sensor CLO	400 - 800 l/h

Material	
T-piece and fittings	PP
O-ring	EPDM
Sampling tap	PVDF/FPM
Stopcock	PVDF/FPM
Reducer	Stainless steel 1.4571

Connectors	
Sensor	G 1"
Sampling tap	G 1/4"
Hose on sampling tap	6 x 4 mm
Sample water line	G 1"

	Order no.
Installation fitting for chlorine sensor CLO	1047238

Accessories

	Order no.
Stopcock	1048213

Spare Parts

	Order no.
Sampling tap	1047266



1.6 Accessories Sensor Technology



pk_6_072

Immersion pipe adapter for dissolved oxygen sensor DO 1-mA-20 ppm

PVC adapter for connection of the DO 1-mA-20 ppm dissolved oxygen sensor to an immersion pipe with 1-1/4 inch internal thread.

DULCOTEST® Sensors for Dissolved Oxygen See page → 1-82

	Order no.
Immersion tube adapter for DO 1-mA-20 ppm	1020537

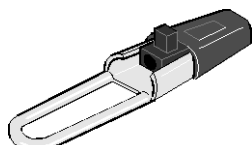

pk_6_073

Mounting bracket for cable of dissolved oxygen sensor DO 1-mA-20 ppm

The stainless steel and polyamide cable bracket is used to guide and fix the sensor cable inside the DO 1-mA-20 ppm dissolved oxygen sensor.

DULCOTEST® Sensors for Dissolved Oxygen See page → 1-82

	Order no.
Cable bracket for DO 1-mA-20 ppm	1020539

Pipe adapter for dissolved oxygen sensor DO 2-mA-10 ppm

The PVC adapter is a spare part for the DO 2-mA-10 ppm dissolved oxygen sensor. The DO 2-mA-10 dissolved oxygen sensor can be adapted to fit metric or imperial tubing by fitting half of the adapter with 1-1/2 inch outside diameter, the other half with 50 mm outside diameter and at both ends with 1-1/4 inch internally threaded tube attached by means of a corresponding 45° standard angle piece (provided by the customer).

DULCOTEST® Sensors for Dissolved Oxygen See page → 1-82

	Order no.
Pipe adapter for DO 2-mA-10 ppm	1020538

Railing bracket for plastic pipes

Stainless steel and plastic bracket for fixing of plastic tubes with 50 mm outside diameter to rails (e.g. on pools in sewage plants). Spare part for "dissolved oxygen" sensor: DO 2-mA-10 ppm.

DULCOTEST® Sensors for Dissolved Oxygen See page → 1-82

	Order no.
Railing bracket for DO 2-mA-10 ppm	1020536

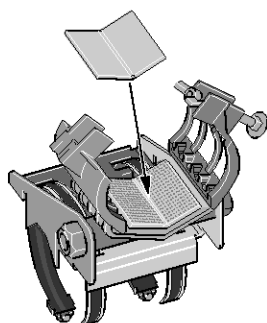

pk_6_010



1.7 Application Examples

Application and Ordering Examples for the DULCOMETER® Compact See page → 2-33

D1Cb and D1Cc Application and Ordering Examples See page → 2-24

DACb application and ordering examples See page → 2-8

Application Examples: Treatment of Swimming Pool Water in Public Baths See page

Application Example: Measurement of Key Chemical Water Parameters at Various Points in the Treatment of Drinking Water See page





2.0 Measuring and Control Units DULCOMETER®

2.0.1

Measuring and Control Units DULCOMETER®

DULCOMETER® controllers provide maximum process reliability with a comprehensive range of uses. Different measured variables can be precisely determined. Depending on the application, the control action of the DULCOMETER® controllers are precisely adapted to the respective requirements. Different mountings enable versatile use.

The advantages at a glance:

- excellent measuring reliability, for example by means of symmetrical input with pH/ORP
- excellent measuring precision, for example by means of high-ohmic input with pH/ORP
- minimal interference resistance, for example by AC voltage interference suppression
- Two-wire system for interference-resistant measurement
- Versatile use, thanks to the many options and different mountings

DULCOMETER® controllers, DULCOTEST® sensors and ProMinent® metering pumps – thereby ideally coordinating the entire control circuit with measurement, regulation, metering and registration.

Controller selection table

Function	DACb	Compact	D1Cb	D1Cc
Measured variablen				
pH	✓	✓	✓	✓
ORP	✓	✓	✓	✓
Chlorine	✓	✓	✓	✓
Chlorine dioxide	✓		✓	✓
Chlorite	✓		✓	✓
Bromine	✓		✓	✓
Conductivity conductive	✓	✓		
Conductivity inductive		✓		
Conductivity via mA	✓		✓	✓
Peracetic acid	✓		✓	✓
Hydrogen peroxide	✓		✓	✓
Ozone	✓		✓	✓
Dissolved oxygen	✓		✓	✓
Fluoride			✓	✓
0/4...20 mA standard signal general measured variables	✓		✓	✓
Power supply				
90 – 253V	✓	✓	✓	✓
~ 24 V DC	✓			
Method of installation, degree of protection				
Wall mounted IP 65			✓	
Control panel mounting IP 54, 1/4 DIN				✓
Combination housing (wall mounting, pillar assembly) IP 66 + IP 67. Installation on control panel IP 54	✓	✓		
Measurement				
Number of measuring channels	2 or 3 optionally available	1	1	1
Sensor monitoring of pH	✓	✓	✓	✓
Temperature compensation for pH	✓	✓	✓	✓
Temperature compensation for conductivity		✓		
pH compensation for chlorine	✓			
Control				
PID controller	✓	✓	✓	✓
Monodirectional controller (e.g. with pH acid or alkali)	✓	✓		
Bidirectional controller (e.g. with pH acid and alkali)	✓		✓	✓
Control inputs				
Digital control inputs	✓, 4/7	✓, 1	✓, 1	✓, 1

2.0 Measuring and Control Units DULCOMETER®

Function	DACb	Compact	D1Cb	D1Cc
Control outputs				
Control of metering pump by pulse frequency	✓, 2/4	✓	✓, 2	✓, 2
Control of solenoid valve/motor-driven metering pump	✓	✓	✓	✓
Interference variable processing (flow) via mA	✓			
Interference variable processing flow via frequency (e.g. of contact water meter)	✓			
Metering time monitoring with deactivation of the control variable	✓	✓	✓	✓
Output relay configurable as limit value relay	✓, 2	✓, 1	✓, 2	✓, 2
Cycle timer	✓, 2		✓, 2	✓, 2
Real time timer	✓, 2			
Outputs				
Analogue output 0/4...20 mA	✓, 2/3	✓, 1	✓, 1	✓, 1
Special functions				
Data logger with SD card	✓			
Web server via LAN	✓			
Parameter set switch-over via timer	✓			
Parameter set switch-over via contact	✓			
PROFIBUS® DP	✓			
Modbus RTU	✓			
Subsequent extension of functions via enabling code	✓		✓	✓
Operating hour counter	✓		✓	✓

2





2.1 Controller DULCOMETER® diaLog DACb

2.1.1

Controller DULCOMETER® diaLog DACb

Water parameter analysis made easy – with the DULCOMETER® diaLog DACb

Do you wish a simple controller for water analysis? One that is easy to operate and with which you can freely select between all common measured variables per channel? There is one: our all-rounder DULCOMETER® diaLog DACb! What is more, it is Ethernet-/LAN-capable and can be ideally integrated into existing networks.

The controller DULCOMETER® diaLog DACb is our compact all-rounder for water analysis. With its specially designed functionalities, e.g. processing or interference variables and switchover of control parameters, it closes the control circuit between DULCOTEST® sensors and ProMinent® metering pumps. The two measuring and control channels of the DULCOMETER® diaLog DACb can be individually configured to meet customer requirements. Everything that you need for the reliable treatment of industrial and process water, potable water as well as swimming pool water.

Your benefits

- Simple operation thanks to a clearly arranged display
- More for your money: two measuring and control channels now in the basic configuration
- Versatile use: all common measured variables can be set per channel and subsequently altered
- Control from everywhere: LAN-capable and convenient remote access via integrated web server
- Maximum flexibility: individually adjustable to different operating statuses, e.g. Day-Night mode
- Excellent process safety and reliability: avoidance of incorrect metering by time-based monitoring of control variables
- Global application options: 24 operating languages can be selected and changed
- Minimal time and effort: effortless duplication of device settings
- Precise monitoring and documentation: Event, calibration and measured data logger with easy-to-access SD memory card
- Optimum communication: Integration into customer networks by means of different field bus systems (PROFIBUS® DP and Modbus RTU, PROFINET)

Technical Details

- Measured variables: pH, ORP, chlorine, chlorine dioxide, chlorite, bromine, conductivity, peracetic acid, hydrogen peroxide, ozone, dissolved oxygen and fluoride
- Method of installation, degree of protection: Combination housing (wall mounting, control panel mounting, pillar assembly) IP 67 and IP 66
- Control: two measuring and control channels, each with independent monodirectional PID controller (optional: two bidirectional PID controllers)
- 24 V DC protective low voltage supply e.g. by means of solar system or in the wet area of waterworks
- Temperature compensation for pH and for chlorine dioxide process sensor CDP, pH compensation for chlorine
- Digital inputs for the processing of control signals, e.g. of process water limit contacts, remote stop control and to monitor the liquid levels in chemical storage tanks
- Control outputs for electronically controlled metering pumps and solenoid valves
- Interference variable processing: simple control of water parameters in flowing water by processing the flow in the control algorithm
- Adaptation of the controller setpoint to changed process conditions is possible via remote control by means of the mA signal of a PLC Programmable Logic Controller or with higher requirements via the field bus option

Field of application

- Measurement and control of water parameters in industrial and process water treatment plants
- Monitoring of the water parameters potable water
- Measurement of pH value and disinfection parameters in the food and beverage industry
- Measurement and control of the hygiene parameters in swimming pools
- Monitoring of the chlorine dioxide concentration in systems for legionella control and prevention, for example in schools, hotels or hospitals
- Measurement of the disinfection parameters of irrigation and sprinkler irrigation water in market gardens

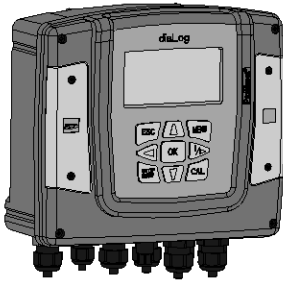

P_DM_0031_SW1

NEW

2.1 Controller DULCOMETER® diaLog DACb

Technical Data

Measuring range	mV connection type: pH: 0.00 ... 14.00 ORP voltage: -1500 ... +1500 mV Connection type mA (amperometric measured variables, measuring ranges corresponding to the sensors): Chlorine Chlorine dioxide Chlorite Bromine Ozone Hydrogen peroxide (PER sensor) Hydrogen peroxide (PEROX sensor with PEROX transducer V2 Order No. 1047979) Peracetic acid Dissolved oxygen Connection type mA (potentiometer measured variables, measuring ranges corresponding to the transmitter): pH ORP voltage Fluoride Conductivity (measuring ranges corresponding to the transmitters): via Transmitter 0/4 ... 20 mA Temperature: via Pt 100/Pt 1000, measuring range 0 ... 150 °C
Resolution	pH: 0.01 ORP voltage: 1 mV Temperature: 0.1 °C Amperometric analysis (chlorine etc.): 0.001/0.01 ppm, 0.01 vol.%, 0.1 vol.%
Accuracy	0.3% based on the full-scale reading
Measurement input	pH/ORP (input resistance > 0.5 x 10 ¹² Ω)
Temperature compensation	Pt 100/Pt 1000 for pH, chlorine dioxide (CDP) sensor and fluoride
Correction range	0 ... 100 °C
pH compensation range for chlorine	Sensor CLE 3 and CLE 3.1: 6.5 ... 8.5, sensor CBR: 6.5 ... 9.5
Disturbance signals	Flow via 0/4 ... 20 mA or contact water meter 1 - 500 Hz, the interference variable acts on both channels
Control characteristic	P/PID control
Control	2 x bidirectional control
Analogue outputs	2 (3) x 0/4 ... 20 mA electrically isolated, max. load 450 Ω, range and assignment (measured, correction, control variable) can be set
Control outputs	2 x 2 pulse frequency outputs for metering pump control 2 relays (limit value, 3-point step or pulse length control)
Alarm relay	250 V ~3 A, 700 VA contact type changeover contact
Digital control inputs	2 (5) as a remote control input for the functions pause control / sample water fault, parameter set switch-over, level monitoring of chemical tanks
Electrical connection	90 – 253 V, 50/60 Hz, 25 VA, 24 V DC
Field bus connection	PROFIBUS®-DP, Modbus RTU, PROFINET
Ambient temperature	0 ... 50°C (for use indoors or with a protective enclosure)
Enclosure rating	Wall-mounted: IP 66 and IP 67 (NEMA 4X) Installation in the control cabinet: IP 54 for control cabinet door
Tests and approvals	CE, MET (corresponding to UL according to IEC 61010)
Housing material	PC with flame proofing equipment
Dimensions	250 x 220 x 122 mm (WxHxD)
Weight	1.3 kg
Standard equipment	
Basic measuring variable	<ul style="list-style-type: none"> ■ AA: 2 measuring channels with freely selectable measured variables for mA. Including interference variable and pH compensation for chlorine ■ VA: 2 measuring channels with freely selectable measured variables for mV (pH and ORP) and mA. Including interference variable and pH compensation for chlorine ■ VV: 2 measuring channels for pH and ORP.



2.1 Controller DULCOMETER® diaLog DACb

- L3: 2 measuring channels for the measured variable conductive conductivity
- PID controller with pulse frequency-based metering pump control for 2 metering pumps.
- 2 analogue outputs for measured value, correction value or control variable (dependent on the optional equipment).
- 4 digital inputs for sample water fault detection, pause and parameter switch-over.
- 2 output relays selectable as limit value, cycle timer, real-time timer or intermittent programmable control output (depending on the optional equipment).
- Measured variables and language selection during commissioning.
- Temperature compensation of the pH, chlorine dioxide (CDP) and fluoride measurement via Pt 100/Pt 1000.
- 22 operating languages: all European languages as well as Chinese, Russian, Thai, Korean. The operating language is selected during commissioning and can be changed at any time by a keyboard shortcut. The documentation language is selected via the identity code. A data carrier is also supplied that contains all other languages.
- Saving and transfer of device parametrisation by means of the SD card.
- Calibration and event data logger (without SD card, data is saved in the controller).
- Interference variable processing (flow) via frequency (contact water meter).
- Subsequent upgrade of the software function by means of an activation key or firmware update.

Optional equipment for 3rd pH measuring channel

Package 2

- 3rd mA output
- Two additional metering pumps control
- External remote setpoint via an analogue signal for channel 1.

Package 3

- Third complete measuring and control channel with PID controller.
- 3rd analogue output for measured value, correction value or control variable (depending on the optional equipment).
- 3 additional digital inputs, e.g. for level monitoring, pause and sample water alarm for channel 2.
- Temperature compensation of the pH, chlorine dioxide (CDP) and fluoride measurement.

Package 4

- Combination of packages 2 and 3 (only one channel for amperometric sensors is available with the interference variable mA).

Communication options

- Measurement data logger with SD card
- Visualisation of the measured data using a web server via LAN NS a PC/tablet PC and web browser
- PROFIBUS®-DP, Modbus RTU

Hardware extension

- Protective RC circuit for output relay: Protects the output relay if inductive loads are to be switched (e.g. solenoid valves or motors). Not with 24 V DC electrical connector.

A complete measuring point comprises:

- Transmitter/controller DACb (see identity code)
- Fitting: DGMa..., DLG III ..., immersion fitting
- pH sensor (identity code-dependent)
- ORP sensor (identity code-dependent)
- Chlorine, chlorine dioxide, chlorite, bromine, dissolved oxygen sensor
- Transducer for pH or ORP dependent on the cable length (> 10 m)
- Sensor cable

(for further information: Immersion Fittings see page → 1-128; pH Sensors With SN6 or Vario Pin Plug-In Head see page → 1-10; ORP Sensors with Fixed Cable see page → 1-43; Sensors for Chlorine see page → 1-49; Transmitter 4 ... 20 mA (Two-Wire System) see page → 2-96; Sensor Accessories see page → 1-119)

Accessories for controller DULCOMETER® diaLog DACb

	Order no.
Cable combination, coaxial, Ø 5 mm 0.8 m - SN6 - pre-assembled	1024105
Cable combination, coaxial, Ø 5 mm 2 m - SN6 - pre-assembled	1024106
Cable combination, coaxial, Ø 5 mm 5 m - SN6 - pre-assembled	1024107
SN6 coaxial connector, retrofit, D1Cb, DACa	1036885
Fitting kit for DAC control panel installation	1041095

NEW



2.1 Controller DULCOMETER® diaLog DACb

2.1.2 Identity Code Ordering System for diaLog DACb, Wall Mounting IP 67

DACb		Mounting type	
W	Wall mounting	S	Control panel mounting
		Design	
00	with ProMinent logo		
		Operating voltage	
4	24 V DC	6	100 - 230 VAC 50/60 Hz
		Basic measured variables	
VA	2 channels, mV/mA measuring input, e.g. pH/chlorine, 2 pumps PID	AA	2 channels, mA/mA measuring input, e.g. chlorine dioxide/chlorite, 2 pumps PID and Pt 100/Pt 1000
VV	2 channels, mV/mV measuring input, e.g. pH/pH, 2 pumps PID and Pt 100/Pt 1000	L3	2 channels, 2 x conductive conductivity and Pt 100/Pt 1000
		Extended functions	
0	none	2	Package 2: interference variable (mA) or external remote setpoint via mA or pH compensation for chlorine (all acting on channel 1)
3	Package 3: third measurement + control, additionally 2 pumps, additionally 3 control inputs	4	Package 4: Combination of packages 2 and 3
		Software default settings	
0	no default setting	1	Batch neutralisation
2	Flow neutralisation	3	pH/ORP measurement/control
4	pH/Cl ₂ measurement/control	5	pH/ClO ₂ measurement/control
6	pH/Cl ₂ measurement/control interference variable	7	ClO ₂ /ORP measurement/control
P	pH/ORP-Private Pool	S	Default setting for swimming pool
T	pH/ORP/chlorine pool		
		Connection of the measured variables	
0	all sensor inputs via terminal	1	max. 2 mV inputs via SN 6 coaxial connector
		Digital sensor / actuator connectors	
0	none		
		Communication interface	
X	none	A	Modbus RTU, terminal
B	Profibus DPV1, terminal	E	LAN with web server, connection via M12 C coded
G	Profinet (2xM12)		
		Data logger	
0	no data logger	1	with data logger
		Hardware extension	
0	none	1	Protective RC circuit (relay)
		Approvals	
00	none	01	CE (Standard)
		Certificates	
0	none		
Documentation language			
00	no document	DE	German
EN	English	ES	Spanish
FR	French	BG	Bulgarian
CS	Czech	DA	Danish
SV	Swedish	ET	Estonian
EL	Greek	FI	Finnish
HR	Croatian	HU	Hungarian
IT	Italian	JA	Japanese
KO	Korean	LT	Lithuanian
LV	Latvian	NL	Dutch
PL	Polish	PT	Portuguese
RO	Romanian	SL	Slovenian
SK	Slovakian		

2





2.1 Controller DULCOMETER® diaLog DACb

2.1.3 Retrospective function extension for the diaLog DACb measuring and control system

Prerequisite:

Channel 2 must be available in the controller. Missing hardware must be retrofitted in the factory.

Channel 2 can be enabled from either package 2 or package 3. The packages correspond to the ones also described in the identity code. The data logger function can always be enabled.

The activation code can only be used for the relevant controller with the specified serial number.

The activation code can be transmitted via email and is then read into the controller from the SD card or entered over the controller keypad. The enabled function is then immediately available and need only be activated and parametrised.

The following information must be available to determine the activation code:

- The serial number of the controller in question (see operating menu under “Diagnostics”, “Device information”) and
- the desired upgrade package.

		Order no.
Based on package 2	Upgrade: Package 2 to package 3	1047874
	Upgrade: Package 2 to package 4	1047875
Based on package 3	Upgrade: Package 3 to package 4	1047876
		Order no.
Based on 0=no data logger	Upgrade: Data logger	1047877

2.1 Controller DULCOMETER® diaLog DACb

2.1.4 DACb application and ordering examples

The application examples contain typical combinations of components for measuring stations in applications in the areas of swimming pool, drinking water, waste water and the food industry.

Components of a complete measuring and control system

- 1 Measuring and control device e.g. DACa
- 2a Measuring line e.g. coaxial cable for pH and ORP sensors, Pt 100/Pt 1000
- 2b Measuring line 2-core for amperometric sensors with mA signal and transducer
- 3 Transducer 4 ... 20 mA (for two wire system), DMTa or pH V1
- 4 Sensor, e.g. pH single-rod sensor
- 5 Fitting e.g. in-line probe housing type DGMA
- 6 Stopcock sample water line
- 7 Sampling tap
- 8 Buffer solutions (pH/ORP)
- 9 Signal cable (metering pump control)
- 10 Actuator e.g. Beta® metering pump

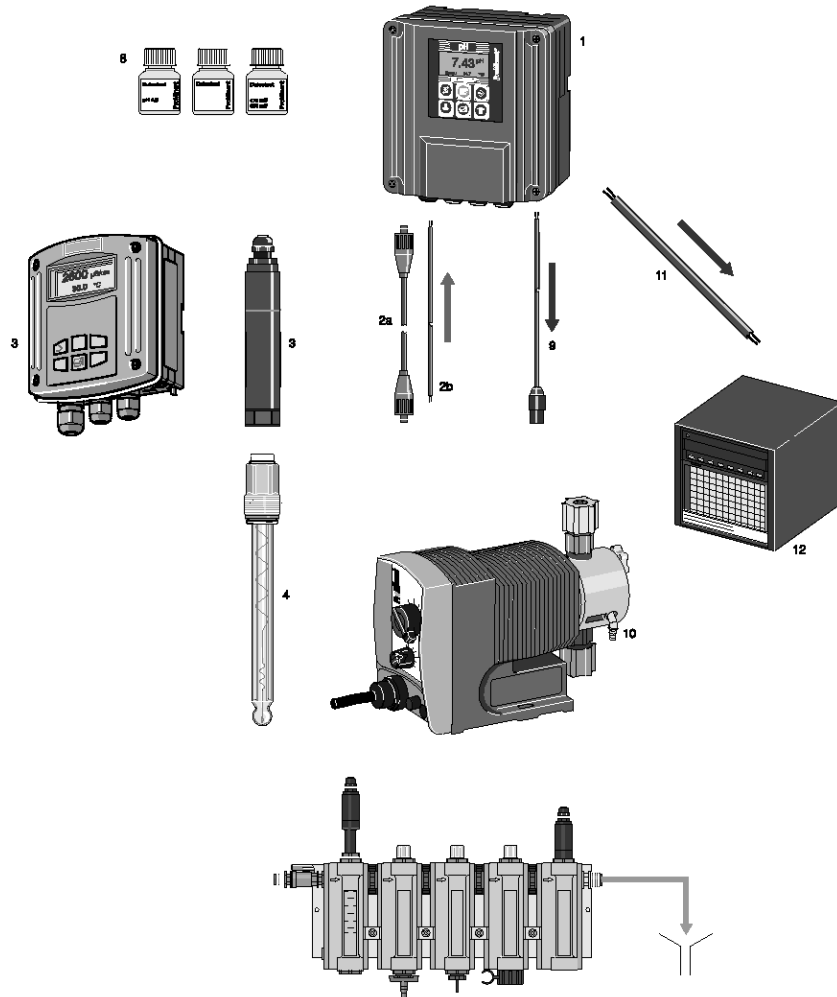

AP_MSR_0006_SW3

Examples for:

- 1 Treatment of swimming pool water and decorative wells/fountains
- 2 Potable water monitoring
- 3 Monitoring of waste water (pH neutralisation)
- 4 Applications in the food industry
- 5 Odour reduction during exhaust air scrubbing





2.1 Controller DULCOMETER® diaLog DACb

2.1.5 Application Examples, Treatment of Swimming Pool Water

Private swimming pool with measurement and metering of acid and chlorine based on the ORP value

Tasks and applications

The pool water of a private outdoor swimming pool, used for only a short time every year, is to be treated. Sulphuric acid is used to correct the pH and sodium-calcium hypochlorite is used as a disinfectant. The disinfectant is to be regulated on the basis of the ORP value (a comparative calibration with a DPD 1 measurement should be carried out at regular intervals, likewise calibration of the pH sensor).

Type DF2a peristaltic pumps are to be controlled. The sample water flow is to be monitored and upon failure, the controller should stop.

Components of the measuring/control station

Quantity		See page	Order no.
1	2-channel controller for pH and ORP diaLog DACb with data logger and protective RC circuit	→ 2-3	DACa00613000011010EN
1	pH sensor PHES 112 SE	→ 1-11	150702
1	Cable combination coaxial 2 m-SN6 Ø 5 mm, pre-assembled	→ 2-70	1024106
1	ORP sensor RHES-Pt-SE	→ 1-33	150703
1	Cable combination coaxial 2 m-SN6 Ø 5 mm, pre-assembled	→ 2-70	1024106
1	In-line probe housing DGMA with sample water scale and limit switch	→ 1-126	DGMA 320T000
2 m	Control line LiYY 2 x 0.25 mm ² Ø 4 mm (e.g. sensor)	→ 1-121	725122

Benefits

- Simple operation, controller with plain text operator guidance in 24 languages
- Recording of measured data
- Automatically correct pH value and correct disinfectant concentration
- All products are selected to operate correctly with each other

Private swimming pool with measurement and metering of acid and bromine

Tasks and applications

The pool water of a private outdoor swimming pool, used for only a short time every year, is to be treated. Sulphuric acid is used to correct the pH and bromine (BCDMH) is used as a disinfectant, that is dissolved and dosed via a bromine sluice. The disinfectant is to be regulated on the basis of a bromine measurement (a comparative calibration using a DPD 1 measuring unit should be carried out at regular intervals, likewise calibration of the pH sensor). The measured values are to be recorded. A DF2a peristaltic pump for pH correction and the solenoid valve of a bromine sluice are to be controlled. The sample water flow is to be monitored and upon failure, the controller should stop.

Components of the measuring/control station

Quantity		See page	Order no.
1	2-channel controller for pH and bromine diaLog DACb with data logger and protective RC circuit	→ 2-3	DACa00613000011010EN
1	pH sensor PHES 112 SE	→ 1-11	150702
1	Sensor connection cable, coaxial 2 m, SN 6 pre-assembled	→ 1-119	1005672
1	Bromine sensor BCR 1-mA-10 ppm	→ 1-70	1041698
2 m	Control line LiYY 2 x 0.25 mm ² Ø 4 mm (e.g. sensor)	→ 1-121	725122
1	In-line probe housing DGMA with sample water scale and limit switch	→ 1-126	DGMA311T000
2 m	Control line LiYY 2 x 0.25 mm ² Ø 4 mm (e.g. sensor)	→ 1-121	725122

Benefits

- Simple operation, controller with plain text operator guidance in 24 languages
- Recording of measured data
- Automatically correct pH value and correct concentration of disinfectant
- All products are matched

2.1 Controller DULCOMETER® diaLog DACb

Private swimming pool with measurement of free chlorine and pH value

Tasks and applications

The pool water of a frequently-used private indoor swimming pool is to be treated. Sulphuric acid is used to correct the pH and sodium-calcium hypochlorite is used as a disinfectant. The disinfectant is to be regulated on the basis of the chlorine concentration (a comparative calibration with a DPD 1 measurement should be carried out at regular intervals, likewise calibration of the pH sensor). Beta® 4b metering pumps are to be controlled.

Components of the measuring/control station

Quantity		See page	Order no.
1	2-channel controller for pH and chlorine diaLog DACb with data logger	→ 2-3	DACa00613000010010EN
1	Chlorine sensor CLE 3-mA 2 ppm	→ 1-51	792920
2 m	Control line LiYY 2 x 0.25 mm ² Ø 4 mm (e.g. sensor)	→ 1-121	725122
1	pH sensor PHES 112 SE	→ 1-11	150702
1	Cable combination coaxial 2 m-SN6 Ø 5 mm, pre-assembled	→ 2-70	1024106
1	In-line probe housing DGMa with sample water scale and limit switch	→ 1-126	DGMa311T000
2 m	Control line LiYY 2 x 0.25 mm ² Ø 4 mm (e.g. sensor)	→ 1-121	725122

Benefits

- Simple operation, controller with plain text operator guidance
- Recording of measured data
- Automatically correct pH value and direct measurement and control of chlorine concentration
- All products are matched

Oxidation of well water with hydrogen peroxide

Tasks and applications

The water of a decorative well or fountain is to be disinfected/oxidised using hydrogen peroxide. The addition of hydrogen peroxide is to be measured. Metering is dependent on the measured value.

If with a control variable of 60% the setpoint is reached after 1 hour, then metering should enter the basic load settings and an alarm should be set (a calibration of the hydrogen peroxide sensor using a comparative measurement is required at regular intervals).

Components of the measuring/control station

Quantity		See page	Order no.
1	2-channel controller for hydrogen peroxide diaLog DACb with data logger	→ 2-3	DACa00610000010010EN
1	Hydrogen peroxide sensor PER 1-mA-50 ppm	→ 1-86	1030511
2 m	Control line LiYY 2 x 0.25 mm ² Ø 4 mm (e.g. sensor)	→ 1-121	725122
1	DGMa in-line probe housing with sample water limit contact	→ 1-126	DGMa301T000
2 m	Control line LiYY 2 x 0.25 mm ² Ø 4 mm (e.g. sensor)	→ 1-121	725122

Benefits

- Simple operation, controller with plain text operator guidance
- Recording of measured data
- If the setpoint has not been reached within 1 hour, the dosing monitor signals via the alarm relay and sets control to an adjustable basic load
- All products are matched



2.1 Controller DULCOMETER® diaLog DACb

2.1.6 Application Examples, Potable Water Monitoring

Measurement and control of ozone in water works for pre-oxidation of the raw water

Tasks and applications

In the treatment of potable water in a water works a measuring and control station is needed at the pre-oxidation stage at the inlet to the water works for the ozone oxidising and disinfectant agent used. With a constant flow, the fluctuating attrition of the ozone, caused by the changing quality of the raw water, is to be compensated on the basis of the measured variables. The following conditions must be met:

- Oxidising agent / disinfectant: Ozone with a concentration to be set to 0.2 ppm
- Raw water: Surface water with a pH of 7.3-7.6 and a temperature of 5 °C-17 °C
- Installation of the measuring station in the bypass of the process flow
- Alarm to signal transgression of upper and lower limit values
- Display of measured results and calibration via a measuring instrument in the proximity of the bypass installation and transmission of the measured value to the control desk via an electrically isolated 4-20 mA signal
- Alarm to signal lowering of sample water flow

Components of the measuring/control station

Quantity		See page	Order no.
1	2-channel controller for ozone diaLog DACb with data logger	→ 2-3	DACa00610000010010EN
1	Ozone sensor OZE 3-mA-2 ppm	→ 1-80	792957
2 m	Control line LiYY 2 x 0.25 mm ² Ø 4 mm (e.g. sensor)	→ 1-121	725122
1	DGMa in-line probe housing with sample water limit contact	→ 1-126	DGMa301T000
2 m	Control line LiYY 2 x 0.25 mm ² Ø 4 mm (e.g. sensor)	→ 1-121	725122

Benefits

- Precise, self-regulating process management with changing raw water quality by the completely automated measuring and control station with variable-dependent control of ozone concentration
- Reliable, safe operation thanks to alarm signalling in the event of limit value transgression and lowering of sample water flow
- The control is monitored by transmission of the measured value as an electrically isolated 4-20 mA output signal by the controller to the control panel

Waterworks with control measurement of chlorine

Tasks and applications

The chlorine concentration in the outlet of a water works is to be monitored. Metering is performed with the volume proportional to the water flow. A magnetic flow meter with a 4-20 mA output signal directly controls a metering pump.

If the setpoint is not reached for at least 5 minutes, then a limit value relay should switch and signal via a signal generator that the stroke length of the metering pump must be increased. Conversely, monitoring should also be performed to determine if too much chlorine has been dosed (calibration of the chlorine sensor should be performed at regular intervals by means of a DPD 1 comparative measurement).

Components of the measuring/control station

Quantity		See page	Order no.
1	2-channel controller for chlorine diaLog DACb with data logger	→ 2-3	DACa00610000010010EN
1	Chlorine sensor CLE 3-mA-0.5 ppm	→ 1-51	792927
2 m	Control line LiYY 2 x 0.25 mm ² Ø 4 mm (e.g. sensor)	→ 1-121	725122
1	DGMa in-line probe housing with sample water limit contact	→ 1-126	DGMa301T000
2 m	Control line LiYY 2 x 0.25 mm ² Ø 4 mm (e.g. sensor)	→ 1-121	725122

Benefits

- Simple operation, controller with plain text operator guidance
- Recording of measured data
- Signalling via a limit value relay if the setpoint has been reached after 5 minutes.
- All products are matched



2.1 Controller DULCOMETER® diaLog DACb

Measurement and control of free chlorine with feedforward control in a waterworks

Tasks and applications

A measuring and control station is needed for the "free chlorine" disinfectant in the treatment of drinking water in a water works. Metering is largely proportional to the flow (magnetic flow meter 4...20 mA). However control can also be proportionately variable-dependent to compensate for peaks of chlorine loss, for instance in the event of rainfall. The following conditions must be met:

- Disinfectant: free chlorine with an adjustable concentration of 0.2 mg/l
- Raw water: source water with a pH of 7.0-7.5 and a temperature of 1-13 °C
- Installation of the measuring station in the bypass of the process flow
- Display of measured results and calibration via a measuring instrument in the proximity of the bypass installation and transmission of the measured value and control variable to the control panel via PROFIBUS®-DP
- Alarm to signal lowering of sample water flow (via PROFIBUS®-DP)
- Alarm signalling the transgression of the preset upper and lower limit values (via PROFIBUS®-DP)
- The measured data are to be recorded in the controller.

Components of the measuring/control station

Quantity		See page	Order no.
1	2-channel controller for chlorine with interference variable processing diaLog DACb with data logger and PROFIBUS-DP	→ 2-3	DACa00612000410010EN
1	Chlorine sensor CLE 3-mA-0.5 ppm	→ 1-51	792927
2 m	Control line LiYY 2 x 0.25 mm ² Ø 4 mm (e.g. sensor)	→ 1-121	725122
1	DGMa in-line probe housing with sample water limit contact	→ 1-126	DGMa301T000
2 m	Control line LiYY 2 x 0.25 mm ² Ø 4 mm (e.g. sensor)	→ 1-121	725122

Benefits

- Precise, self-regulating disinfection by a fully automated measuring and control station
- Flow-proportional control can be safeguarded by proportionate variable-dependent control to combat peaks of attrition
- Reliable, safe operation thanks to alarm signalling in the event of limit value transgression and lowering of sample water flow
- The control is monitored by transmission of the measured value and control variable via the PROFIBUS®-DP to the control panel

Waterworks with measurement of chlorine dioxide

Tasks and applications

The chlorine dioxide concentration in the outlet of a water works is to be monitored. Metering is in the first place performed with the volume proportional to the water flow. A MID with a 4 – 20 mA output signal is used.

If the proportionality is insufficient, then up to 20% of the control variable is made available by the controller in an additive manner (a calibration of the chlorine dioxide sensor by means of a DPD 1 comparative measurement is required at regular intervals). The DACa/DACb controller pulse frequency is used to control the ProMinent Bello Zon® chlorine dioxide generation system.

Components of the measuring/control station

Quantity		See page	Order no.
1	2-channel controller for chlorine dioxide diaLog DACb with data logger	→ 2-3	DACa00610000010010EN
1	Chlorine dioxide sensor CDE 2-mA-0.5 ppm	→ 1-74	792930
2 m	Control line LiYY 2 x 0.25 mm ² Ø 4 mm (e.g. sensor)	→ 1-121	725122
1	DGMa in-line probe housing with sample water limit contact	→ 1-126	DGMa301T000
2 m	Control line LiYY 2 x 0.25 mm ² Ø 4 mm (e.g. sensor)	→ 1-121	725122

Benefits

- Simple operation, controller with plain text operator guidance
- Recording of measured data
- Primarily, chlorine dioxide metering proportional to flow. Where this is not possible additive measured-value dependent control
- All products are matched





2.1 Controller DULCOMETER® diaLog DACb

Legionella prevention in public buildings

Tasks and applications

The chlorine dioxide and the chlorite concentration are to be monitored and recorded in the fresh water distribution system of a public building for the prevention of legionella. Chlorite is a disinfection by-product of chlorine dioxide that arises if germs have been killed. The chlorite concentration is limited using a limit value of 0.2 mg/l.

Components of the measuring/control station

Quantity		See page	Order no.
1	2-channel controller for pH and chlorine diaLog DACb with data logger	→ 2-3	DACa00613000010010EN
1	Chlorine dioxide sensor CDE 2-mA-0.5 ppm	→ 1-74	792930
5 m	Control line LiYY 2 x 0.25 mm ² Ø 4 mm (e.g. sensor)	→ 1-121	725122
1	Chlorite sensor CLT 1-mA-0.5 ppm	→ 1-78	1021596
5 m	Control line LiYY 2 x 0.25 mm ² Ø 4 mm (e.g. sensor)	→ 1-121	725122
1	DGMa in-line probe housing with sample water limit contact	→ 1-126	DGMa302T000
5 m	Control line LiYY 2 x 0.25 mm ² Ø 4 mm (e.g. sensor)	→ 1-121	725122

Benefits

- Simple operation, controller with plain text operator guidance
- Recording of all measured data
- Upon exceeding of the chlorite limit value, a limit value relay switches the chlorine dioxide metering off or to a basic load.
- All products are matched

Oxidation of well water with hydrogen peroxide

Tasks and applications

The water drawn from a deep well is to be oxidised using hydrogen peroxide. The addition of hydrogen peroxide is to be measured. Metering is dependent on the measured value.

If with a control variable of 60% the setpoint is reached after 1 hour, then metering should enter the basic load settings and an alarm should be set (a calibration of the hydrogen peroxide sensor using a comparative measurement is required at regular intervals).

Components of the measuring/control station

Quantity		See page	Order no.
1	2-channel controller for hydrogen peroxide diaLog DACb with data logger	→ 2-3	DACa00610000010010EN
1	Hydrogen peroxide sensor PER 1-mA-50 ppm	→ 1-86	1030511
2 m	Control line LiYY 2 x 0.25 mm ² Ø 4 mm (e.g. sensor)	→ 1-121	725122
1	DGMa in-line probe housing with sample water limit contact	→ 1-126	DGMa301T000
2 m	Control line LiYY 2 x 0.25 mm ² Ø 4 mm (e.g. sensor)	→ 1-121	725122

Benefits

- Hygienic trouble-free well water
- Simple operation, controller with plain text operator guidance
- Recording of measured data
- If the setpoint has not been reached within 1 hour, the dosing monitor signals via the alarm relay and sets control to an adjustable basic load
- All products are matched

2.1 Controller DULCOMETER® diaLog DACb

2.1.7 Application Examples, Waste Water Monitoring

Neutralisation of the waste water of an industrial plant (non-steady receipt of water)

Tasks and applications

Turbid waste water with a significantly fluctuating pH value and intermittent occurrence is to be neutralised in batch operation. The waste water is pumped into an interim tank and is neutralised using acid and alkali. The pH value should be measured and regulated in a stirred batch storage tank. The pH sensor should be fitted at a typical position on the tank using an immersion fitting. Once it has been neutralised the water is pumped onwards, and the pH value should be controlled again in this pipe.

The DACb controller data logger automatically records the pH values and temperatures of both pH measuring points. In parallel, a digital input is used to record the end position switch of the storage tank outlet. In this way, it can be precisely determined how high the pH value was at the time of draining. Any limit value transgressions that may have occurred are also recorded in the data logger. If a limit value transgression occurs, the shut-off valve closes automatically. A neutral zone is additionally defined in the controller. If the pH value comes within this neutral zone, no control takes place. There may be solids in the waste water.

Components of the pH measuring/control station in the collection tank

Quantity		See page	Order no.
1	2-channel controller for pH and ORP diaLog DACb with data logger and protective RC circuit	→ 2-3	DACa00613000011010EN
1	Cable combination coaxial 5 m-SN6, shield connection	→ 1-119	1024107
1	DULCOTEST® pH sensor PHER 112 SE	→ 1-16	1001586
1	Temperature sensor Pt 100 SE	→ 1-46	305063
1	Cable combination of control line 5 m SN6, open end (Pt 100, Pt 1000)	→ 1-120	1003208
1	Immersion fitting with 3 sensor slots IPHa 3-PP	→ 1-129	1008602
1	Cable combination coaxial 5 m - SN6 - pre-assembled	→ 1-129	1008633

Components of the measuring/control station in the outlet

Quantity		See page	Order no.
1	DULCOTEST® pH sensor PHER 112 SE	→ 1-16	1001586
1	Cable combination coaxial 5 m-SN6, shield connection	→ 1-119	1024107
1	Retractable process assembly WA-PH 1	→ 1-134	1020631

Note: the use of other sensors is also possible depending on the quality of the waste water (see Selection Guide for pH Sensors DULCOTEST®→ 1-1)

With seriously contaminated waste water with solid matter content

Quantity	Name	See page	Order no.
1	pH sensor PHEX 112 SE	→ 1-17	305096

With clear waste water

Quantity	Name	See page	Order no.
1	pH sensor PHEP 112 SE	→ 1-13	150041

Benefits

- Simple operation, controller with plain text operator guidance in 24 languages
- Recording of all measured data and the opened or closed status of the shut-off valve
- pH limit value monitoring of drainage water
- pH control and final checking in a controller
- All products are selected to operate correctly with each other



2.1 Controller DULCOMETER® diaLog DACb

Neutralisation of the waste water of an industrial plant (continuous receipt of water)

Tasks and applications

In an industrial plant, waste water arises in a continuous manner (continuous production), and can be acidic or alkaline. The water runs through a manifold. The flow volume is measured using a flow meter because the flow varies within wide limits. There is a pH sensor with a pH sliding retractable assembly in the pipework with which the pH value is adjusted. Further along the pipework the pH value is used once again as a final check.

The flow signal of the flow meter is evaluated as a multiplicative interference variable in the DACb controller, i.e. this flow signal = disturbance variable is used to evaluate the controller control variable (control of the metering pumps) in a flow dependent manner. In the event of a similar control deviation (deviation of the actual from the setpoint), for example, with a reduced flow less acid or alkali is necessary than with an increased flow. Provision of this information makes it easier for the controller to adhere to the setpoint. In the absence of this flow information, a PID controller alone could not perform such a task or could only perform it with great difficulty. A neutral zone is additionally defined in the controller. If the pH value comes within this neutral zone, no control takes place.

There may be solids in the waste water.

The DACb controller data logger automatically records the pH values and temperatures of both pH measuring points. Any limit value transgressions that may have occurred are also recorded in the data logger.

Components of the pH measuring/control station in the collection tank

Quantity		See page	Order no.
1	2-channel controller for 2 x pH and temperature diaLog DACb with data logger	→ 2-3	DACa00614000011010EN
1	DULCOTEST® pH sensor PHER 112 SE	→ 1-16	1001586
1	Cable combination coaxial 5 m-SN6, shield connection	→ 1-119	1024107
1	Retractable process assembly WA-PH 1	→ 1-134	1020631

Components of the measuring/control station in the outlet

Quantity		See page	Order no.
1	DULCOTEST® pH sensor PHER 112 SE	→ 1-16	1001586
1	Cable combination coaxial 5 m-SN6, shield connection	→ 1-119	1024107
1	Retractable process assembly WA-PH 1	→ 1-134	1020631

Note: the use of other sensors is also possible depending on the quality of the waste water (see Selection Guide for pH Sensors DULCOTEST® → 1-1)

With seriously contaminated waste water with solid matter content

Quantity	Name	See page	Order no.
1	pH sensor PHEX 112 SE	→ 1-17	305096

With clear waste water

Quantity	Name	See page	Order no.
1	pH sensor PHEP 112 SE	→ 1-13	150041

Benefits

- Simple operation, controller with plain text operator guidance in 24 languages
- Processing of the flow signal as a disturbance variable
- Recording of all measured data and the opened or closed status of the shut-off valve
- pH limit value monitoring for the waste water
- pH control and final checking in a controller
- All products are selected to operate correctly with each other



2.1 Controller DULCOMETER® diaLog DACb

2.1.8 Application Examples in the Food Industry

Bottler disinfection in the beverage industry

Tasks and applications

Continuous disinfection of the filler with disinfection solution means this sensitive part of the bottling process is reliably sterilised. Continuous spraying with disinfectant solution means high hygiene requirements are fulfilled.

The disinfectant solution comprises water with additional chlorine dioxide. The concentration of the chlorine dioxide is measured and set to the desired value using the DACb controller. From time to time the chlorine dioxide concentration must be increased.

An alternative parameter set can be activated in the DACb via a switch input. In this way, a switchover, regularly required, can be carried out smoothly without the need for continual adaptation of the setpoint in the controller menu.

The measured data is to be recorded.

Components of the measuring/control station

Quantity		See page	Order no.
1	2-channel controller for chlorine dioxide diaLog DACb with data logger	→ 2-3	DACa00610000010010EN
1	Chlorine dioxide sensor CDR 1-mA-2 ppm	→ 1-76	1033393
5 m	Control line LiYY 2 x 0.25 mm ² Ø 4 mm (e.g. sensor)	→ 1-121	725122
1	DGMa in-line probe housing with sample water limit contact	→ 1-126	DGMa301T000
5 m	Control line LiYY 2 x 0.25 mm ² Ø 4 mm (e.g. sensor)	→ 1-121	725122

Benefits

- Simple operation, controller with plain text operator guidance in 24 languages
- Recording of all measured data
- Switchover of control parameters via an external potential-free contact
- All products are selected to operate correctly with each other

Irrigation water disinfection for useful plants

Tasks and applications

The irrigation water from e.g. salad seedlings is drawn from a well. The water could be contaminated with germs which could harm the salad seedlings. To prevent this, the irrigation water is disinfected using chlorine dioxide. The irrigation water requirement varies. Consequently, the irrigation water volume flow is measured. The irrigation water volume flow is used as an additive disturbance variable to control the adding of chlorine dioxide dependent on the required chlorine dioxide concentration and the irrigation water flow.

All measured data are to be recorded. The irrigation water may contain suspended matter.

Components of the measuring/control station

Quantity		See page	Order no.
1	2-channel controller for chlorine dioxide with additive interference variable processing diaLog DACb with data logger	→ 2-3	DACa00612000010010EN
1	Chlorine dioxide sensor CDR 1-mA-2 ppm	→ 1-76	1033393
5 m	Control line LiYY 2 x 0.25 mm ² Ø 4 mm (e.g. sensor)	→ 1-121	725122
1	DGMa in-line probe housing with sample water limit contact	→ 1-126	DGMa301T000
5 m	Control line LiYY 2 x 0.25 mm ² Ø 4 mm (e.g. sensor)	→ 1-121	725122

Benefits

- Simple operation, controller with plain text operator guidance in 24 languages
- Processing of the irrigation water flow signal as an interference variable
- Recording of all measured data
- Switchover of control parameters via an external potential-free contact
- All products are selected to operate correctly with each other





2.1 Controller DULCOMETER® diaLog DACb

2.1.9 Odour Reduction Application Examples (Clarification Plants)

Exhaust air scrubbers, clarification plants or fragrance production

Tasks and applications

The odorous components of the exhaust air from a clarification plant are to be scrubbed out using an exhaust air scrubber and oxidised using hydrogen peroxide. Here the hydrogen peroxide concentration is to be regulated to maintain 100 mg/l. As the exhaust air is acidic, the pH value is to be regulated to maintain 7.2. The measured values are to be recorded. The scrubbing water temperature can vary widely in the range 5 - 35 °C. Beta® 4b metering pumps are to be pulse frequency controlled.

Components of the measuring/control station

Quantity		See page	Order no.
1	2-channel controller for pH and chlorine diaLog DACb with data logger	→ 2-3	DACa00613000010010EN
1	pH sensor PHES 112 SE	→ 1-11	150702
1	Sensor connection cable, coaxial 2 m, SN 6 pre-assembled	→ 1-119	1005672
1	H ₂ O ₂ sensor PEROX-H2.10 P	→ 1-87	792976
1	PEROX transducer V2, measuring range switchable up to 20/200/2,000 mg/l	→ 1-87	1034100
5 m	Control line LiYY 2 x 0.25 mm ² Ø 4 mm (e.g. sensor)	→ 1-121	725122
1	Temperature sensor Pt 100 SE	→ 1-46	305063
1	Cable combination of control line 5 m SN6, open end (Pt 100, Pt 1000)	→ 1-120	1003208
1	Reference electrode REFP-SE	→ 1-46	1018458
1	DLG III A with PVC hose connection	→ 1-125	914955
1	Polishing paste (90 g tube)	→ 1-46	559810
1	Magnetic stirrer 100-240 V		790915
1	Magnetic stirring PTFE (magnetic stir bar) 15 x 6	–	790917
1	Photometer DT3B	→ 2-94	1039317

Benefits

- Simple operation, controller with plain text operator guidance in 24 languages
- Recording of all measured data
- Simultaneous measurement and control of the pH value and the hydrogen peroxide concentration
- All products are selected to operate correctly with each other

2.2 Controller DULCOMETER® D1Cb/D1Cc

2.2.1 Controller DULCOMETER® D1Cb/D1Cc

The water analysis workhorse



The controller DULCOMETER® D1Cb/D1Cc can be used for control tasks in potable water treatment, waste water treatment and many other areas. Safe, convenient and clear, thanks to the large illuminated graphic display, plain text operating menu and pH sensor monitoring.

The D1Cb/D1Cc controller is a 1-channel P/PID controller for the measured variables pH, ORP, chlorine, chlorine dioxide, chlorite, ozone, bromine, peracetic acid, hydrogen peroxide, fluoride, dissolved oxygen and conductivity via mA. The sensors for pH and ORP can be directly connected via coaxial cable or using the 4-20 mA sensor input. The controller can bidirectionally control the measured variables, monitor limit values and transmit the measured value via an mA output, e.g. to a PLC Programmable Logic Controller. The mA output can optionally also be configured as an interference variable output. The controller has two pulse frequency outputs to control two metering pumps (raise and lower). Two output relays can optionally be used as limit value relays or to control motor-driven pumps or solenoid valves. An alarm relay signals the occurrence of a fault. A digital input is used to switch off the control or to process a sample water limit contact by remote control. The impact of temperature on the measurements can be provided by temperature measurement or by manual input. Menu-driven operation is possible in 20 languages.

Your benefits

- Flexibility through free selection of variables from all measured variables
- Safety through sensor monitoring of pH for glass breakage and line breakage
- Flexibly upgradable, thanks to subsequent activation option of functions by means of an activation code
- Various installation options: wall-mounted or installation in a control cabinet



Technical Details

- Measured variables: pH, ORP, chlorine, chlorine dioxide, chlorite, bromine, conductivity, peracetic acid, hydrogen peroxide, ozone, dissolved oxygen and fluoride
- Method of installation, degree of protection: D1Cb wall mounting IP 65, D1Cc control panel mounting IP 54, 1/4 DIN
- Measurement: 1 measuring channel, temperature compensation for pH
- Control: PID controller, bidirectional controller (e.g. with pH acid and alkali)
- Control inputs: 1 digital control input

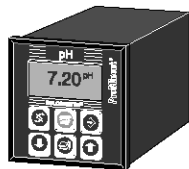

pk_5_002
D1Cb (top), D1Cc (bottom)

Field of application

- Measurement and control of water parameters in industrial and process water treatment plants
- Waste water neutralisation
- Measurement of the pH value and the disinfection parameters in potable water treatment and in the food and beverage industry
- Measurement and control of the hygiene parameters in swimming pools

Technical Data

Measuring range

Type of connection mV:

pH 0.00 ... 14.00
ORP - 1,000 ... +1,000 mV

Type of connection mA:

Chlorine: 0.00...0.500/2.00/5.00/10.0/20.0/50.0/100.0 ppm
Chlorine dioxide: 0.00...0.500/2.00/10.0/20.0 ppm
Chlorite: 0.02...0.50/0.1...2 ppm
Bromine: 0.02...2.0/0.1...10.0 ppm
Ozone: 0.00...2.00 ppm
Hydrogen peroxide, PER1 sensor : 2.0...200.0/20...2,000 ppm
Peracetic acid: 1...20/10...200/100...2,000 mg/l
Dissolved oxygen: 0.1...10/0.1...20 ppm
pH: 0.00...14.00
ORP: 0...+1,000 mV
Conductivity: 0...20/200/1,000 mS/cm, via mA converter
Temperature: 0...100 °C via mA converter

Resolution

pH: 0.01 pH
ORP: 1 mV
Amperometric (e. g. chlorine): 0.001/0.01 ppm, 0.01 vol.%

Accuracy

0.5% of the upper measuring range value

Measurement input

SN6 (input resistance > 0.5 x 10¹² Ω)



2.2 Controller DULCOMETER® D1Cb/D1Cc

Correction variable	Temperature via Pt 100/Pt 1000
Correction range temp.	0 ... 100 °C
Control characteristic	P/PID control
Control	2-way control
Signal current output	1 x 0/4-20 mA galvanically isolated max. load 450 Ω Adjustable range and allocation (measured variable, correction variable, controlled variable)
Control outputs	2 pulse frequency outputs for metering pump actuation 2 relays (limit value or pulse length)
Alarm relay	250 V ~ 3 A, 700 VA changeover contact
Electrical connection	90 – 253 V, 50/60 Hz, 15 VA
Ambient temperature	-5 ... 50 °C
Enclosure rating	Wall mounting: IP 65 Control panel version: IP 64
Dimensions	Wall mounting: 198 x 200 x 76 mm (WxHxD) Control panel version: 96 x 96 x 145 mm (WxHxD) (D1Cc)
Weight	0.8 kg

- Flexibly upgradable thanks to subsequent activation option for functions by means of activation code (see D1Ub/D1Uc upgrade identity code)
- Equipped for the most important basic requirements in water treatment
- Illuminated graphic display
- Operator guidance through clear text menu available in 20 languages in the controller
- Automatic buffer detection for pH calibration

D1Ub Identity Code Ordering System, Subsequent Function Upgrade for D1Cb see page → 2-23

A complete measurement station comes with:

- Measuring transducer/controller D1Cb/D1Cc (see Identity code)
- Fitting: DGMa..., DLG III ..., immersed fitting
- pH sensor (corresponding to Identity code)
- ORP sensor (corresponding to Identity code)
- Chlorine, chlorine dioxide, chlorite, bromine, dissolved oxygen sensor
- Transducer for pH or ORP (corresponding to Identity code)
- Sensor cable

Accessories for Controller DULCOMETER® D1Cb/D1Cc

	Order no.
Cable combination, coaxial, Ø 5 mm 0.8 m - SN6 - pre-assembled *	1024105
Cable combination, coaxial, Ø 5 mm 2 m - SN6 - pre-assembled *	1024106
Cable combination, coaxial, Ø 5 mm 5 m - SN6 - pre-assembled *	1024107
SN6 coaxial connector, retrofit, D1Cb, DACa	1036885
Protective RC circuit, retrofit kit for D1Cb	1034238
Spare parts kits D1Cc (frame, support brackets)	790130

* For measured variable connection = 5



2.2 Controller DULCOMETER® D1Cb/D1Cc

2.2.2 Identity Code Ordering System DULCOMETER® D1Cb, Wall Mounting

D1Cb	Installation	W	Wall mounting (IP 65)
	Version	00	With ProMinent logo
	Power supply	6	90...253 V, 48/63 Hz (wide-range power supply)
	Approvals	01	CE approval
	Hardware add-on I	0	None
	Hardware add-on II	0	None
		1	RC protection for power relays
	External connection	0	None
	Software defaults	U	Software default setting (all of the following selection options are automatically set to the default setting)
		V	Software pre-set (the following selection options must be evaluated)
	Measured variable presetting	0	Universal (choice upon commissioning)
		A	Peracetic acid
		B	Bromine
		C	Chlorine
		D	Chlorine dioxide
		F	Fluoride
		H	Hydrogen peroxide (PER1)
		I	Chlorite
		P	pH
		R	ORP
		S	0/4...20 mA Standard signal, general
		T	Temperature via mA transducer
		X	Dissolved oxygen
		Z	Ozone
		L	Conductivity via mA transducer
	Connection of the measured variable (presetting)	1	mA terminal can be switched to mV, all measured variables selectable
		2	SN6 plug for P or R or standard signal 0/4-20mA, all measured variables selectable
		5	mV terminal can be switched to mA, all measured variables can be selected
	Correction variable	0	None
		2	Temperature Pt 100/1000 via terminal (for pH and conductivity)
		4	Manual temperature entry (for pH and conductivity)
	Control input	0	None
		1	Pause control
	Signal output	0	None
		1	1 Analogue signal output 0/4...20 mA
	Relay control	G	Alarm and 2 limit value relays or 2 timer relays
		M	Alarm and 2 solenoid valve relays or 2 timer relays
	Pump control	0	None
		2	2 pumps via pulse frequency
	Control characteristic	0	None
		1	P-control
		2	PID control
	Language	00	no default
		DE	German
		EN	English
		ES	Spanish
		SV	Swedish
		PT	Portuguese
		CN	Chinese
		FR	French
		CZ	Czech
		JP	Japanese
		KR	Korean
		NO	Norwegian
		NL	Dutch
		PL	Polish
		RU	Russian
		TH	Thai
		HU	Hungarian
		IT	Italian
		DK	Danish
		FI	Finish
		GR	Greek



2.2 Controller DULCOMETER® D1Cb/D1Cc

2.2.3 Identity Code Ordering System DULCOMETER® D1Cc, Control Panel Mounting

D1Cc	Type of mounting
	D Control panel installation (IP 54)
	Design
	00 With ProMinent logo
	Operating voltage
	6 90...253 V, 48/63 Hz (wide voltage power supply)
	Certification
	01 CE approval
	Hardware extension I
	0 None
	Hardware extension II
	0 None
	External connection
	0 None
	Software default settings
	U Software basic setting (all of the following selection options are automatically set to the basic setting)
	V Software pre-set (the following selection options must be evaluated)
	Measured variable default setting
	0 Universal (choice upon commissioning)
	A Peracetic acid
	B Bromine
	C Chlorine
	D Chlorine dioxide
	F Fluoride
	H Hydrogen peroxide (PER1)
	I Chlorite
	P pH
	R ORP
	S 0/4...20 mA standard signal, general
	T Temperature via mA transducer
	X Dissolved oxygen
	Z Ozone
	L Conductivity via mA transducer
	Measured variable connection (default setting)
	1 mA terminal can be switched to mV, all measured variables can be selected
	5 mV terminal can be switched to mA, all measured variables can be selected
	Correction variable
	0 None
	2 Temperature Pt 100/1000 via terminal (for pH and conductivity)
	4 Manual temperature input (for pH and conductivity)
	Control input
	0 None
	1 Pause control
	Signal output
	0 None
	1 1 analog signal output 0/4...20 mA
	Power activation
	G Alarm and 2 limit value relays or 2 timer relays
	M Alarm and 2 solenoid valve relays or 2 timer relays
	Pump activation
	0 None
	2 2 pumps via pulse frequency
	Control characteristic
	0 None
	1 Proportional control
	2 PID control
	Language
	00 no default setting
	DE German
	EN English
	ES Spanish
	SV Swedish
	PT Portuguese
	CN Chinese
	FR French
	CZ Czech
	JP Japanese
	KR Korean
	NO Norwegian
	NL Dutch
	PL Polish
	RU Russian
	TH Thai
	HU Hungarian
	IT Italian
	DK Danish
	FI Finnish
	GR Greek

If software default setting **U** = software default setting is selected, the measured variables pH or ORP can be selected during commissioning. The menu language is automatically requested.

The connection of the measured variable is 5 = mV input for pH/ORP via shield clamp.

With all other options, the default settings (first option) are selected.

The controller with software with default settings can also be ordered with an order number.

	Order no.
Controller in basic setting D1CbW00601000U01000G0000	1036423



2.2 Controller DULCOMETER® D1Cb/D1Cc

Subsequent activation of functions is possible at any time using an activation key.

This activation key can only be used with the controller with the specified serial number. The activation code can be provided by phone, fax or e-mail and can be simply entered into the control keyboard. The new function is then available and need only be enabled and parametrised.

The following information is essential to obtain the activation code:

- Serial number of the controller (refer to nameplate or operator menu under "General Settings and Information")
- Current identity code of the controller (refer to operator menu under "General Settings and Information")
- Required identity code



2.2 Controller DULCOMETER® D1Cb/D1Cc

2.2.4 D1Ub Identity Code Ordering System, Subsequent Function Upgrade for D1Cb

D1Ub	Software defaults
	Software pre-set
	Default - measured variable
0	Universal (choice of measured variable upon commissioning)
	Connection of measured variable
1	Standard signal 0/4-20 mA, all measured variables and mV input for pH/ORP (standard)
	Correction variable
0	None
2	Temperature Pt100/Pt1000 via terminal (for pH and conductivity)
4	Manual temperature entry (for pH and conductivity)
	Control input
0	None
1	Pause control
	Signal output
0	None
1	1 analogue signal output 0/4-20 mA
	Power control
G	Alarm and 2 limit value relays or 2 timer relays
M	Alarm and 2 solenoid valve relays or 2 timer relays
	Pump control
0	None
2	2 pumps via pulse frequency
	Control modes
0	None
1	P control
2	PID control
	Language
00	no default

2.2.5 D1Uc Identity Code Ordering System, Subsequent Function Upgrade for D1Cc

D1Uc	Software defaults
	Software preset
	Default - measured variable
0	Universal (choice of measured variable upon commissioning)
	Connection of measured variable
1	Standard signal 0/4-20 mA, all measured variables and mV input for pH/ORP (standard)
	Correction variable
0	None
2	Temperature Pt100/Pt1000 via terminal (for pH and conductivity)
4	Manual temperature input (for pH and conductivity)
	Control input
0	None
1	Pause control
	Signal output
0	None
1	1 Analogue signal output 0/4-20 mA
	Power control
G	Alarm and 2 limit value relays or 2 timer relays
M	Alarm and 2 solenoid valve relays or 2 timer relays
	Pump control
0	None
2	2 pumps via pulse frequency
	Control modes
0	None
1	Proportional control
2	PID control
	Language
00	no default setting



2.2 Controller DULCOMETER® D1Cb/D1Cc

2.2.6 D1Cb and D1Cc Application and Ordering Examples

The application examples contain typical combinations of components for measuring stations in applications in the areas of swimming pool, drinking water, waste water and the food industry.

Components of a complete measuring and control system

- 1 Measuring and control device e.g. DACa
- 2a Measuring line e.g. coaxial cable for pH and ORP sensors, Pt 100/Pt 1000
- 2b Measuring line 2-core for amperometric sensors with mA signal and transducer
- 3 Transducer 4 ... 20 mA (for two wire system), DMTa or pH V1
- 4 Sensor, e.g. pH single-rod sensor
- 5 Fitting e.g. in-line probe housing type DGMA
- 6 Stopcock sample water line
- 7 Sampling tap
- 8 Buffer solutions (pH/ORP)
- 9 Signal cable (metering pump control)
- 10 Actuator e.g. Beta® metering pump

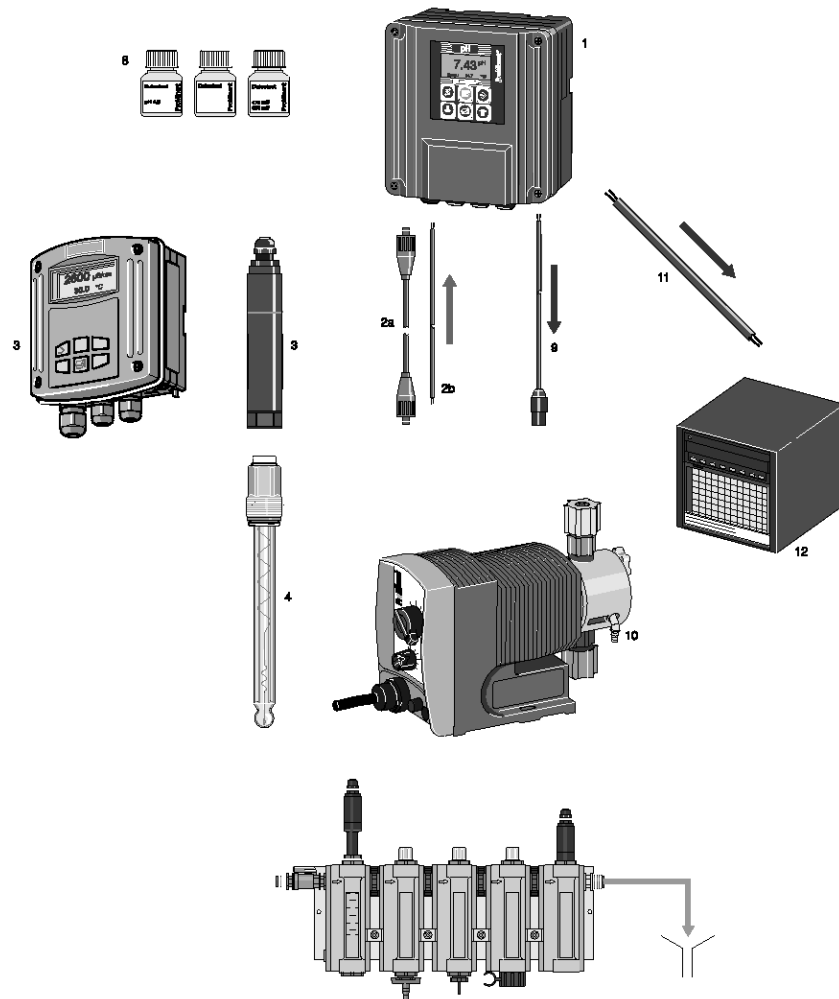

AP_MSR_0006_SW3

Examples for:

- 1 Treatment of swimming pool water and decorative wells/fountains
- 2 Potable water monitoring
- 3 Treatment and monitoring of waste water (pH neutralisation)
- 4 Applications in the food industry



2.2 Controller DULCOMETER® D1Cb/D1Cc

2.2.7 Application Examples, Treatment of Swimming Pool Water

Private swimming pool with measurement and metering of acid and chlorine based on the ORP value

Tasks and applications

The pool water of a private outdoor swimming pool, used for only a short time every year, is to be treated. Sulphuric acid is used to correct the pH and sodium-calcium hypochlorite is used as a disinfectant. The disinfectant is to be regulated on the basis of the ORP value (a comparative calibration with a DPD 1 measurement should be carried out at regular intervals, likewise calibration of the pH sensor).

Type DF2a peristaltic pumps are to be controlled. The sample water flow is to be monitored and upon failure, the controller should stop.

Components of the measuring/control station

Quantity		See page	Order no.
1	1 channel controller D1Cb, pH	→ 2-18	D1CBW00601010VP5010M21EN
1	pH sensor PHES 112 SE	→ 1-11	150702
1	Cable combination coaxial 2 m-SN6 Ø 5 mm, pre-assembled	→ 2-70	1024106
1	1 channel controller D1Cb, ORP	→ 2-18	D1CBW00601010VR5010M21EN
1	ORP sensor RHES-Pt-SE	→ 1-33	150703
1	Sensor connection cable, coaxial 2 m, SN 6 pre-assembled	→ 1-119	1005672
1	In-line probe housing DGMa with sample water scale and limit switch	→ 1-126	DGMa 320T000
2 m	Control line LiYY 2 x 0.25 mm ² Ø 4 mm (e.g. sensor)	→ 1-121	725122

Benefits

- Simple operation, controller with plain text operator guidance in 20 languages
- Automatically correct pH value and correct disinfectant concentration
- All products are selected to operate correctly with each other

Private swimming pool with measurement and metering of acid and bromine

Tasks and applications

The pool water of a private outdoor swimming pool, used for only a short time every year, is to be treated. Sulphuric acid is used to correct the pH and bromine (BCDMH) is used as a disinfectant, that is dissolved and dosed via a bromine sluice. The disinfectant is to be regulated on the basis of a bromine measurement (a comparative calibration using a DPD 1 measuring unit should be carried out at regular intervals, likewise calibration of the pH sensor). The measured values are to be recorded. A DF2a peristaltic pump for pH correction and the solenoid valve of a bromine sluice are to be controlled. The sample water flow is to be monitored and upon failure, the controller should stop.

Components of the measuring/control station

Quantity		See page	Order no.
1	1 channel controller D1Cb, pH	→ 2-18	D1CBW00601010VP5010M21EN
1	pH sensor PHES 112 SE	→ 1-11	150702
1	Sensor connection cable, coaxial 2 m, SN 6 pre-assembled	→ 1-119	1005672
1	1 channel controller D1Cb, bromine	→ 2-18	D1CBW00601010VB1010M21EN
1	Bromine sensor BCR 1-mA-10 ppm	→ 1-70	1041698
2 m	Control line LiYY 2 x 0.25 mm ² Ø 4 mm 2 m (e.g.: flow sensor)	→ 1-121	725122
1	In-line probe housing DGMa with sample water scale and limit switch	→ 1-126	DGMa311T000
2 m	Control line LiYY 2 x 0.25 mm ² Ø 4 mm (e.g. sensor)	→ 1-121	725122

Benefits

- Simple operation, controller with plain text, operator guidance in 20 languages, display of measured data
- Automatically correct pH value and correct disinfectant concentration
- All products are selected to operate correctly with each other

2.2 Controller DULCOMETER® D1Cb/D1Cc

Private swimming pool with measurement of free chlorine and pH value

Tasks and applications

The pool water of a frequently-used private indoor swimming pool is to be treated. Sulphuric acid is used to correct the pH and sodium-calcium hypochlorite is used as a disinfectant. The disinfectant is to be regulated on the basis of the chlorine concentration (a comparative calibration with a DPD 1 measurement should be carried out at regular intervals, likewise calibration of the pH sensor). Beta® 4b metering pumps are to be controlled.

Components of the measuring/control station

Quantity		See page	Order no.
1	1 channel controller D1Cb, pH	→ 2-18	D1CBW00601010VP5010M21EN
1	pH sensor PHES 112 SE	→ 1-11	150702
1	Sensor connection cable, coaxial 2 m, SN 6 pre-assembled	→ 1-119	1005672
1	1 channel controller D1Cb, chlorine	→ 2-18	D1CBW00601010VC5010M21EN
1	Chlorine sensor CLE 3-mA 2 ppm	→ 1-51	792920
2 m	Control line LiYY 2 x 0.25 mm ² Ø 4 mm 2 m (e.g.: flow sensor)	→ 1-121	725122
1	In-line probe housing DGMA with sample water scale and limit switch	→ 1-126	DGMA311T000
2 m	Control line LiYY 2 x 0.25 mm ² Ø 4 mm (e.g. sensor)	→ 1-121	725122

Benefits

- Simple operation, controller with plain text operator guidance
- Automatically correct pH value and direct measurement and control of chlorine concentration
- All products are matched

Oxidation of well water with hydrogen peroxide

Tasks and applications

The water of a decorative well or fountain is to be disinfected/oxidised using hydrogen peroxide. The addition of hydrogen peroxide is to be measured. Metering is dependent on the measured value.

If with a control variable of 60% the setpoint is reached after 1 hour, then metering should enter the basic load settings and an alarm should be set (a calibration of the hydrogen peroxide sensor using a comparative measurement is required at regular intervals).

Components of the measuring/control station

Quantity		See page	Order no.
1	1 channel controller D1Cb, bromine	→ 2-18	D1CBW00601010VH1010M21EN
1	Hydrogen peroxide sensor PER 1-mA-50 ppm	→ 1-86	1030511
2 m	Control line LiYY 2 x 0.25 mm ² Ø 4 mm (e.g. sensor)	→ 1-121	725122
1	In-line probe housing DGMA with sample water scale and limit switch	→ 1-126	DGMA311T000
2 m	Control line LiYY 2 x 0.25 mm ² Ø 4 mm (e.g. sensor)	→ 1-121	725122

Benefits

- Simple operation, controller with plain text operator guidance
- If the setpoint has not been reached within 1 hour, the dosing monitor signals via the alarm relay and sets control to an adjustable basic load
- All products are matched





2.2 Controller DULCOMETER® D1Cb/D1Cc

2.2.8 Application Examples, Potable Water Monitoring

Waterworks with control measurement of chlorine

Tasks and applications

The chlorine concentration in the outlet of a water works is to be monitored. Metering is performed with the volume proportional to the water flow. A magnetic flow meter with a 4-20 mA output signal directly controls a metering pump.

If the setpoint is not reached for at least 5 minutes, then a limit value relay should switch and signal via a signal generator that the stroke length of the metering pump must be increased. Conversely, monitoring should also be performed to determine if too much chlorine has been dosed (calibration of the chlorine sensor should be performed at regular intervals by means of a DPD 1 comparative measurement).

Components of the measuring/control station

Quantity		See page	Order no.
1	1 channel controller D1Cb, chlorine	→ 2-18	D1CBW00601010VD1010G21EN
1	Chlorine sensor CLE 3-mA-0.5 ppm	→ 1-51	792927
2 m	Control line LiYY 2 x 0.25 mm ² Ø 4 mm (e.g. sensor)	→ 1-121	725122
1	DGMa in-line probe housing with sample water limit contact	→ 1-126	DGMa301T000
2 m	Control line LiYY 2 x 0.25 mm ² Ø 4 mm (e.g. sensor)	→ 1-121	725122

Benefits

- Simple operation, controller with plain text operator guidance
- Signalling via a limit value relay if the setpoint has been reached after 5 minutes.
- All products are matched

Legionella prevention in public buildings

Tasks and applications

The chlorine dioxide and the chlorite concentration are to be monitored and recorded in the fresh water distribution system of a public building for the prevention of Legionella. Chlorite is a disinfection by-product of chlorine dioxide that arises if germs have been killed. The chlorite concentration is limited using a limit value of 0.2 mg/l.

Components of the measuring/control station

Quantity		See page	Order no.
1	1 channel controller D1Cb, chlorine dioxide	→ 2-18	D1CBW00601010VD1010M21EN
1	Chlorine dioxide sensor CDE 2-mA-0.5 ppm	→ 1-74	792930
1 m	Control line LiYY 2 x 0.25 mm ² Ø 4 mm 2 m (e.g.: flow sensor)	→ 1-121	725122
1	1 channel controller D1Cb, chlorite	→ 2-18	D1CBW00601010VI1010M21EN
1	Chlorite sensor CLT 1-mA-0.5 ppm	→ 1-78	1021596
1 m	Control line LiYY 2 x 0.25 mm ² Ø 4 mm 2 m (e.g.: flow sensor)	→ 1-121	725122
1	DGMa in-line probe housing with sample water limit contact	→ 1-126	DGMa302T000
2 m	Control line LiYY 2 x 0.25 mm ² Ø 4 mm (e.g. sensor)	→ 1-121	725122

Benefits

- Simple operation, controller with plain text operator guidance
- Upon exceeding of the chlorite limit value, a limit value relay switches the chlorine dioxide off or to a basic load.
- All products are matched

2.2 Controller DULCOMETER® D1Cb/D1Cc

Oxidation of well water with hydrogen peroxide

Tasks and applications

The water drawn from a deep well is to be oxidised using hydrogen peroxide. The addition of hydrogen peroxide is to be measured. Metering is dependent on the measured value.

If with a control variable of 60% the setpoint is reached after 1 hour, then metering should enter the basic load settings and an alarm should be set (a calibration of the hydrogen peroxide sensor using a comparative measurement is required at regular intervals).

Components of the measuring/control station

Quantity		See page	Order no.
1	1 channel controller D1Cb, hydrogen peroxide	→ 2-18	D1CBW00601010VH1010G21EN
1	Hydrogen peroxide sensor PER 1-mA-50 ppm	→ 1-86	1030511
2 m	Control line LiYY 2 x 0.25 mm ² Ø 4 mm (e.g. sensor)	→ 1-121	725122
1	DGMa in-line probe housing with sample water limit contact	→ 1-126	DGMa301T000
2 m	Control line LiYY 2 x 0.25 mm ² Ø 4 mm (e.g. sensor)	→ 1-121	725122

Benefits

- Simple operation, controller with plain text operator guidance
- If the setpoint has not been reached within 1 hour, the dosing monitor signals via the alarm relay and sets control to an adjustable basic load
- All products are matched





2.2 Controller DULCOMETER® D1Cb/D1Cc

2.2.9 Application Examples, Waste Water Monitoring

Neutralisation of the waste water of an industrial plant

Tasks and applications

In an industrial plant, waste water arises in an intermittent manner (batch production), and can be acidic or alkaline. The water is collected in a storage tank. There is a stirrer in the storage tank, a pH immersion fitting with wet holding cup, based on which the pH value is adjusted. The discharge connecting piece, which can be closed off using a shut-off valve with a limit switch, of a storage tank contains a pH sensor with a pH changeover device, which is used for the final check.

If a limit value transgression occurs, the shut-off valve closes automatically. Additionally, a neutral zone is defined in the controller. If the pH value comes within this neutral zone, no control takes place. There may be solids in the waste water.

Components of the pH measuring/control station in the collection tank

Quantity		See page	Order no.
1	1 channel controller D1Cb, pH	→ 2-18	D1CBW00601010VP5010M21EN
1	DULCOTEST® pH sensor PHER 112 SE	→ 1-16	1001586
1	Cable combination coaxial 5 m-SN6, shield connection	→ 1-119	1024107
1	Temperature sensor Pt 100 SE	→ 1-46	305063
1	Cable combination of control line 5 m SN6, open end (Pt 100, Pt 1000)	→ 1-120	1003208
1	Immersion fitting with 3 sensor slots IPHa 3-PP	→ 1-129	1008602
1	Cable combination coaxial 5 m - SN6 - pre-assembled	→ 1-129	1008633

Components of the measuring/control station in the outlet

Quantity		See page	Order no.
1	1 channel controller D1Cb, pH	→ 2-18	D1CBW00601010VP5010M21EN
1	DULCOTEST® pH sensor PHER 112 SE	→ 1-16	1001586
1	Cable combination coaxial 5 m-SN6, shield connection	→ 1-119	1024107
1	Retractable process assembly WA-PH 1	→ 1-134	1020631

Note: The use of other sensors is also possible depending on the quality of the waste water (see Selection Guide for pH Sensors DULCOTEST® → 1-1)

With seriously contaminated waste water with solid matter content

Quantity	Name	See page	Order no.
1	pH sensor PHEX 112 SE	→ 1-17	305096

With clear waste water

Quantity	Name	See page	Order no.
1	pH sensor PHEP 112 SE	→ 1-13	150041

Benefits

- The waste water pH value is within the specified limit values
- Simple operation, controller with plain text operator guidance in 20 languages
- pH limit value monitoring of drainage water
- All products are selected to operate correctly with each other

2.2 Controller DULCOMETER® D1Cb/D1Cc

2.2.10 Application Examples in the Food Industry

Bottler disinfection in the beverage industry

Tasks and applications

Continuous disinfection of the filler with disinfection solution means this sensitive part of the bottling process is reliably sterilised. Continuous spraying with disinfectant solution means high hygiene requirements are fulfilled.

The disinfectant solution comprises water with additional chlorine dioxide. The concentration of the chlorine dioxide is measured and set to the desired value using the D1Cb controller.

Components of the measuring/control station

Quantity		See page	Order no.
1	1 channel controller D1Cb, chlorine	→ 2-18	D1CBW00601010VD1010G21EN
1	Chlorine dioxide sensor CDR 1-mA-2 ppm	→ 1-76	1033393
5 m	Control line LiYY 2 x 0.25 mm ² Ø 4 mm (e.g. sensor)	→ 1-121	725122
1	DGMa in-line probe housing with sample water limit contact	→ 1-126	DGMa301T000
5 m	Control line LiYY 2 x 0.25 mm ² Ø 4 mm (e.g. sensor)	→ 1-121	725122

Benefits

- Hygienic trouble-free bottling
- Simple operation, controller with plain text operator guidance in 22 languages
- All products are matched

Irrigation water disinfection for useful plants

Tasks and applications

The irrigation water from e.g. salad seedlings is drawn from a well. The water could be contaminated with germs which could harm the salad seedlings. To prevent this, the irrigation water is disinfected using chlorine dioxide. The irrigation water requirement is always constant.

The irrigation water may contain suspended matter.

Components of the measuring/control station

Quantity		See page	Order no.
1	1 channel controller D1Cb, chlorine	→ 2-18	D1CBW00601010VD1010G21EN
1	Chlorine dioxide sensor CDR 1-mA-2 ppm	→ 1-76	1033393
5 m	Control line LiYY 2 x 0.25 mm ² Ø 4 mm (e.g. sensor)	→ 1-121	725122
1	DGMa in-line probe housing with sample water limit contact	→ 1-126	DGMa301T000
5 m	Control line LiYY 2 x 0.25 mm ² Ø 4 mm (e.g. sensor)	→ 1-121	725122

Benefits

- Irrigation water does not harm the seedlings
- Simple operation, controller with plain text operator guidance in 20 languages
- Switchover of control parameters via an external potential-free contact
- All products are selected to operate correctly with each other





2.3 Controller DULCOMETER® Compact

2.3.1 Controller DULCOMETER® Compact



Compact yet fully equipped - the basic water analysis unit

As a controller in water analysis, the DULCOMETER® Compact is the correct controller for control tasks that require only a 1 way control.

The DULCOMETER® Compact controller is a one-channel PID controller for the measured variables pH, ORP, chlorine and inductive conductivity. It can monodirectionally control the measured variable, monitor limit values and transmit the measured value via an mA output, e.g. to a PLC. The mA output can optionally also be configured as a controlled variable output. The controller has one pulse frequency output to control one metering pump. One output relay can optionally be used as an alarm or limit value or to control motor-driven metering pumps or solenoid valves. A digital input is used to switch off the control or to process a sample water limit contact by remote control. The impact of temperature on the measurements can be provided by temperature measurement or by manual input. Menu-driven operation is language-independent.

Your benefits

- Flexibility in the choice of measured variable with pH and ORP
- Always the optimum measured value resolution by auto-ranging with conductivity measurement
- Depending on the requirement, various display options for conductivity, such as: Conductivity, TDS (Total Dissolved Solids), salinity and specific resistance
- Safety through sensor monitoring of pH for glass breakage and line breakage
- Various installation options: wall-mounted, installation on an upright or in a control cabinet



P_DM_0025_SW1

Technical Details

- Measured variables: pH, ORP, chlorine, conductive and inductive conductivity
- Method of installation, degree of protection: Combination housing (wall mounting, control panel mounting, pillar assembly) IP 67, control panel IP 54
- Measurement: 1 measuring channel, temperature compensation for conductivity and pH
- Control: PID controller, monodirectional controller (e.g. with pH acid or alkali)
- Control inputs: 1 digital control input

Field of application

- Measurement and control of water parameters in industrial and process water treatment plants
- Permeate monitoring in reverse osmosis systems
- Measurement and control of the hygiene parameters in swimming pools

Technical Data

Measuring range	pH: 0.00 ... 14 ORP: -1000 ... +1000 mV Chlorine: 0.05 ... 5 ppm, intermittent metering up to 10 ppm, max. 12 h Conductive conductivity: 0.5 µS/cm ... 20 mS/cm (auto-ranging) Inductive conductivity with ICT 1: 200 µS/cm ... 1000 mS/cm (auto-ranging) Inductive conductivity with ICT 2: 20 µS/cm ... 2000 mS/cm (auto-ranging)
Resolution	pH: 0.01 pH ORP: 1 mV Chlorine: 0.01 ppm Conductivity: 0.1 µS/cm (depends on the measuring range)
Accuracy	0.5% of the upper range value
Temperature compensation range	0 ... 120 °C, chlorine 1 ... 45 °C
Control	Monodirectional PID control with selectable control direction
Inputs	Sensor input for the relevant measured variable Temperature sensor input: pH: Pt 1000, chlorine and conductivity: Pt 100/ Pt 1000 1 digital input as a remote control input for the functions pause control / sample water fault

2.3 Controller DULCOMETER® Compact

Outputs	1 pulse frequency output for the control of metering pumps 1 active 0/4...20 mA output configurable as a measured or control variable, max. load: 400 Ω 1 output relay used as a changeover contact, can be configured as an alarm, limit value or pulse width-modulated control output for motor-driven metering pumps
Cell constant, conductive conductivity	0.05 ... 12.0 cm ⁻¹
Voltage supply	100-240 V ±10%, 50/60 Hz, 5 W
Permissible operating temperature	-10 ... +60 °C
Enclosure rating	IP 67, based on NEMA4X
Dimensions	135 x 125 x 75 mm (H x W x D)
Weight	0.5 kg

2.3.2 Identity Code Ordering System DULCOMETER® Compact, Wall Mounting IP 67

DCCa	Type of mounting	
W	Wall/pipe mounting IP 67	
S	With fitting kit for control panel mounting IP 54	
	Design	
00	With ProMinent® logo	
	Operating voltage	
6	90 ... 253 V, 48/63 Hz	
	Measured variable	
C0	Free chlorine	
PR	pH/ORP (switchable)	
L3	Conductive conductivity (unit designation: COND_C)	
L6	Inductive conductivity (unit designation: COND_I)	
	Hardware extension	
0	None	
	Certifications	
01	CE (Standard)	
	Certificates	
0	None	
	Documentation language	
DE	german	
EN	english	
ES	spanish	
IT	italian	
FR	french	
FI	finnish	
BG	bulgarian	
CN	chinese	
CZ	czech	
GR	greek	
HU	hungarian	
JP	japanese	
KR	korean	
LT	lithuanian	
LV	latvian	
NL	dutch	
PL	polish	
PT	portuguese	
RO	romanian	
RU	russian	
SE	swedish	
SK	slovakian	
SI	slovenian	
SV	Swedish	
TH	thai	

Accessories

	Order no.
Cable combination, coaxial, Ø 5 mm 0.8 m - SN6 - pre-assembled *	1024105
Cable combination, coaxial, Ø 5 mm 2 m - SN6 - pre-assembled *	1024106
Cable combination, coaxial, Ø 5 mm 5 m - SN6 - pre-assembled *	1024107
Assembly set for installation in control cabinet	1037273
Chlorine sensor CLB 2-µA-5 ppm	1038902
Chlorine sensor CLB 3-µA-5 ppm	1041696



2.3 Controller DULCOMETER® Compact

2.3.3 Application and Ordering Examples for the DULCOMETER® Compact

The application examples contain typical combinations of components for measuring stations in applications in the areas of swimming pool, drinking water and waste water.

Components of a complete measuring and control system

- 1 Treatment of swimming pool water and decorative wells/fountains
- 2 Potable water monitoring
- 3 Treatment and monitoring of waste water (pH neutralisation)



2.3 Controller DULCOMETER® Compact

2.3.4 Application Examples, Treatment of Swimming Pool Water

Private swimming pool with measurement and metering of acid and chlorine based on the ORP value

Tasks and applications

The pool water of a private outdoor swimming pool, used for only a short time every year, is to be treated. Sulphuric acid is used to correct the pH and sodium-calcium hypochlorite is used as a disinfectant. The disinfectant is to be regulated on the basis of the ORP value (a comparative check with a DPD 1 measurement should be carried out at regular intervals, likewise calibration of the pH sensor).

Type DF2a peristaltic pumps are to be controlled. The sample water flow is to be monitored and upon failure, the controller should stop.

Components of the measuring/control station

Quantity		See page	Order no.
1	Compact controller for pH	→ 2-31	DCCaW006PR0010EN
1	pH sensor PHES 112 SE	→ 1-11	150702
1	Cable combination coaxial 2 m-SN6 Ø 5 mm, pre-assembled	→ 2-70	1024106
1	Compact controller for ORP	→ 2-31	DCCaW006PR0010EN
1	ORP sensor RHES-Pt-SE	→ 1-33	150703
1	Sensor connection cable, coaxial 2 m, SN 6 pre-assembled	→ 1-119	1005672
1	In-line probe housing DGMa with sample water scale and limit switch	→ 1-126	DGMa 320T000
4 m	Control line LiYY 2 x 0.25 mm ² Ø 4 mm (e.g. sensor)	→ 1-121	725122

Benefits

- Operation is simple and independent of the operating language
- Automatically correct pH value and correct concentration of disinfectant
- All products are matched

Private swimming pool with measurement of free chlorine and pH value

Tasks and applications

The pool water of a frequently-used private indoor swimming pool is to be treated. Sulphuric acid is used to correct the pH and sodium-calcium hypochlorite is used as a disinfectant. The disinfectant is to be regulated on the basis of the chlorine concentration (a comparative calibration with a DPD 1 measurement should be carried out at regular intervals, likewise calibration of the pH sensor). Beta® 4b metering pumps are to be controlled.

Components of the measuring/control station

Quantity		See page	Order no.
1	Compact controller for pH	→ 2-31	DCCaW006PR0010EN
1	pH sensor PHES 112 SE	→ 1-11	150702
1	Sensor connection cable, coaxial 2 m, SN 6 pre-assembled	→ 1-119	1005672
1	Compact controller for chlorine	→ 2-31	DCCaW006C00010EN
1	CLB 2-µA-5 ppm	→ 1-59	1038902
1	In-line probe housing DGMa with sample water scale and limit switch	→ 1-126	DGMa 320T000
4 m	Control line LiYY 2 x 0.25 mm ² Ø 4 mm (e.g. sensor)	→ 1-121	725122

Benefits

- Operation is simple and independent of the operating language
- Automatically correct pH value and direct measurement and control of chlorine concentration
- All products are matched





2.3 Controller DULCOMETER® Compact

2.3.5 Application Examples, Potable Water Monitoring

Waterworks with control measurement of chlorine and pH

Tasks and applications

The chlorine concentration in the outlet of a water works is to be monitored. Metering is performed with the volume proportional to the water flow. A magnetically induced flow meter with a 4-20 mA output signal directly controls a metering pump.

If the setpoint is not reached for at least 5 minutes, then a limit value relay should switch and signal via a signal generator that the stroke length of the metering pump must be increased. Conversely, monitoring should also be performed to determine if too much chlorine has been dosed (calibration of the chlorine sensor should be performed at regular intervals by means of a DPD 1 comparative measurement).

Components of the chlorine measuring/control station

Quantity		See page	Order no.
1	Compact controller for chlorine	→ 2-31	DCCaW006C00010EN
1	CLB 2-µA-5 ppm	→ 1-59	1038902
1	DGMa in-line probe housing with sample water limit contact	→ 1-126	DGMa 310T000
2 m	Control line LiYY 2 x 0.25 mm ² Ø 4 mm (e.g. sensor)	→ 1-121	725122

Components of the pH measuring/control station

Quantity		See page	Order no.
1	Compact controller for pH	→ 2-31	DCCaW006PR0010EN
1	DULCOTEST® pH-Sensor PHEP-112-SE	→ 1-13	150041
1	Sensor connection cable, coaxial 2 m, SN 6 pre-assembled	→ 1-119	1005672
1	DGMa in-line probe housing with sample water limit contact	→ 1-126	DGMa 310T000
2 m	Control line LiYY 2 x 0.25 mm ² Ø 4 mm (e.g. sensor)	→ 1-121	725122

Benefits

- Operation is simple and independent of the operating language
- Signalling via a limit value relay if the setpoint has been reached after 5 minutes.
- All products are matched

Waterworks with control measurement of conductivity

Tasks and applications

The conductive conductivity in the outlet of a water works is to be monitored. The measured value is to be transmitted to a PLC via a 4-20 mA analogue signal.

Components of the measuring/control station

Quantity		See page	Order no.
1	Compact controller for conductive conductivity	→ 2-31	DCCaW006L30010EN
1	Conductivity sensor measuring range 20 mS/cm, type LFTK 1	→ 1-101	1002822
1	Screened sensor cable LF, 5 m	→ 1-120	1046026
1	DGMa in-line probe housing with sample water limit contact	→ 1-126	DGMa 310T000
2 m	Control line LiYY 2 x 0.25 mm ² Ø 4 mm (e.g. sensor)	→ 1-121	725122

Benefits

- Operation is simple and independent of the operating language
- Signalling via a limit value relay if the setpoint has been reached after 5 minutes.
- All products are matched

2.3 Controller DULCOMETER® Compact

2.3.6 Application Examples, Waste Water Monitoring

Neutralisation of the waste water of an industrial plant

Tasks and applications

In an industrial plant, waste water arises in an intermittent manner (batch production), the water is always acidic (or always alkaline). The water is collected in a storage tank. There is a stirrer in the storage tank, a pH immersion fitting with wet holding cup, based on which the pH value is adjusted. The storage tank discharge connecting piece contains a pH sensor with a pH changeover device, which is used for the final check.

The control is one-way, i.e. acidic or alkaline. There may be solids in the waste water. The measured values are transferred via the 4-20 mA analogue signal.

Components of the pH measuring/control station in the collection tank

Quantity		See page	Order no.
1	Compact controller for pH	→ 2-31	DCCaW006PR0010EN
1	DULCOTEST® pH sensor PHER 112 SE	→ 1-16	1001586
1	Cable combination coaxial 5 m-SN6, shield connection	→ 1-119	1024107
1	Pt 1000 Temperature sensor	→ 1-46	1002856
1	Cable combination of control line 5 m SN6, open end (Pt 100, Pt 1000)	→ 1-120	1003208
1	Immersion fitting with 3 sensor slots IPHa 3-PP	→ 1-129	1008602

Components of the measuring/control station in the outlet

Quantity		See page	Order no.
1	Compact controller for pH	→ 2-31	DCCaW006PR0010EN
1	DULCOTEST® pH sensor PHER 112 SE	→ 1-16	1001586
1	Cable combination coaxial 5 m-SN6, shield connection	→ 1-119	1024107
1	Retractable process assembly WA-PH 1	→ 1-134	1020631

Note: The use of other sensors is also possible depending on the quality of the waste water (see Selection Guide for pH Sensors DULCOTEST® → 1-1)

For seriously contaminated waste water with solid matter content

Quantity	Name	See page	Order no.
1	pH sensor PHEX 112 SE	→ 1-17	305096

For clear waste water

Quantity	Name	See page	Order no.
1	pH sensor PHEP 112 SE	→ 1-13	150041

Benefits

- Operation is simple and independent of the operating language
- pH limit value monitoring for the waste water
- All products are matched



2.4 Multi-Channel Multi-Parameter Measuring and Control System DULCOMARIN® II

2.4.1

Controller DULCOMARIN® II

Transparency in water analysis in the Dialog controller for up to 16 x 10 measuring points.

Controller DULCOMARIN® II for water analysis: Green technology with energy and chemical saving function. Control of circulating pumps and filter backwash is possible.

The DULCOMARIN® II measuring and control system manages your entire swimming pool and your hot tub: from water treatment to filter control, pool cover, attractions, water heating, solar control, pool and external lighting. System information and messages are clearly and graphically visualised on the coloured display. At the same time, the information can also be transmitted via the internet to a tablet PC or smartphone. Coupling to a building bus is simply possible via KNX, PROFIBUS®-DP, Modbus RTU or OPC. Based on the modern bus technology DULCO®-NET, the system is capable of growing to meet requirements and can be extended at any time. It can be used in high-end private pools, school swimming pools, hotel swimming pools or in public themed baths. Depending on requirements, a potable water treatment system or legionella prevention system can also be integrated. The integrated SoftPLC enables almost all customer requirements to be met. The DISINFECTION Controller design can be used for general water treatment tasks.

Your benefits

- Visualisation made simple: with the embedded web server and a standard web browser
- Simple connection to your PC or PC network or the internet via a LAN interface
- Operation via Apple® iPod, iPad (WLAN access point necessary)
- Control of up to 16 sub-systems, each with 10 measuring parameters, in potable water systems or filter circuits in swimming pools or with general water treatment tasks
- Customer-specific adjustments are possible: A SoftPLC conforming to IEC 61131 also enables customer-specific process control to be integrated in addition to integral processing.
- View current and historical measured data directly on the controller: the integral data logger with screen plotter permits this
- Simply transmit measured data to a PC as standard: SD card and card reader for PC always included
- Simple wiring and subsequent expandability thanks to DULCO®NET bus system
- Intelligent sensors: save sensor data and always be in the optimum measuring range with auto-ranging
- Intelligent metering pumps: find information on operating parameters, such as: Chemical level status and pump capacity in the metering range of 0.74 l/h to 1,030 l/h
- Coupling to a PLC via a PROFIBUS®-DP and Modbus RTU



pk_5_045



Technical Details

- Measured variables: pH, ORP, free chlorine, total chlorine, combined chlorine, bromine, chlorine dioxide, chlorite anion and temperature
- Accuracy: 0.5% of the upper range value
- Control characteristic: P/PI/PID control
- Digital inputs: 5 potential-free inputs
- Signal current output: 4 x 0/4-20 mA
- Interfaces: LAN, SD expansion slot

Field of application

- Measurement and control of the hygiene parameters in swimming pools
- Monitoring of the water parameters in potable waterworks
- Monitoring of the chlorine dioxide concentration in systems for legionella control and prevention, for example in schools, hotels or hospitals

The applications are defined in the identity code

Every potable water system or every filtration circuit has a proprietary on-site calibration option for all measured variables.

What is the Eco!Mode operating mode?

Eco!Mode permits lowering of the circulation capacity when the DIN hygiene parameters pH, ORP, free chlorine and combined chlorine are within the permitted limits.

A circulating pump with frequency converter with analogue input is needed for this.

The reduction can be activated via a remote control, dependent on the DIN hygiene parameters being observed, the time and appropriate activation. A combination of criteria is also possible. If the DIN hygiene parameters are no longer adhered to, then the circulation capacity is again raised to the nominal power.

Lowering pump capacity saves energy and, in so doing, reduces CO₂ emissions.

In addition, upon reaching an adjustable ORP potential, e.g. 780 mV, which signals effective disinfection of the water, chlorine metering is reduced either gradually or in one step. If the DIN hygiene parameters are no longer adhered to, then chlorine metering is again increased to the normal setpoint.



2.4 Multi-Channel Multi-Parameter Measuring and Control System DULCOMARIN® II

What is a web server?

A web server is a software application executed by the DULCOMARIN® II.

The web server delivers web pages with information about measurements, control, sensor calibration and control configuration to a PC with a web browser (e.g. Microsoft® Internet Explorer).

The web server enables simple and straightforward visualisation of the DULCOMARIN® II, without special visualisation software being required on the PC. The web server is independent of the PC's operating system.

The DULCOMARIN® II is connected to a PC via a LAN/Ethernet interface. The connection can be made directly, via a network or via the internet. The cables needed for direct connection to a PC or network connection are included in the option.

Standard commercially available network components can be used as accessories for cables, routers and WLAN access points etc.

The same information can be accessed via the web server as is available on the DULCOMARIN® II itself, for instance changing setpoints for all control variables, switching off the different controllers and entering names for the pools/systems. The exceptions are the control settings and bus configuration that can only be entered directly on the controller.

What is OPC?

OPC stands for Openness, Productivity, Collaboration (formerly OLE for Process Control) and is used to describe a uniform software interface independent of specific manufacturers. OPC Data Access (OPC DA) is based on Windows COM (Component Object Model) and DCOM (Distributed Component Object Model) technology. OPC XML, in contrast, is based on the internet standards XML, SOAP and HTTP.

OPC is used wherever sensors, controllers and controls supplied by different manufacturers are used to create a common, flexible network. Without OPC, two devices would require precise knowledge about the communication options of the other device to be able to exchange data and extensions and exchanges would be correspondingly difficult. With OPC it is sufficient to write an OPC-compliant driver precisely once for each device and ideally this is provided by the manufacturer. An OPC driver can be integrated without extensive adaptation into any large control and monitoring systems.

ProMinent supplies an OPC server/driver, such as this, for the multi-channel measuring and control system DULCOMARIN® II.

The examples shown in the following are suitable for applications in potable water treatment and in swimming pool technology.

Technical Data

Measuring range	pH -1...15 ORP: -1,200 ... +1,200 mV Chlorine, free 0.01...10 ppm/100 ppm Chlorine, total 0.01...10 ppm Chlorine, combined 0.01... 2.00 ppm Bromine: 0.01...10 ppm Chlorine dioxide: 0.01...10 ppm Chlorite anion: 0.10...2 ppm
Temperature	-20 ... 150 °C Pt 100 or Pt 1000
Resolution	0.01 pH / 1 mV / 0.01 ppm / 0.1 °C
Accuracy	0.5% of the final value of the measuring range (at 25 °C)
Measurement input	pH and ORP via terminal mV Chlorine via CANopen bus
Control characteristic	P/PI/PID control, intelligent control
Control	Acid and/or alkali and chlorine (2 control circuits), temperature
Digital inputs	5 potential-free inputs (sample water, pause, 3 pump failures, 2nd parameter set)
Signal current output	4 x 0/4-20 mA max. load 600 Ω range adjustable. Important: An isolating amplifier, e.g. part no. 1033536, is required for connecting to devices that are not electrically isolated.





2.4 Multi-Channel Multi-Parameter Measuring and Control System DULCOMARIN® II

Control outputs	3 reed contacts for acid, alkali or flocculants and chlorine (pulse frequency to control metering pumps) 3 relays (pulse length) contact type changeover to control solenoid valves or peristaltic pumps
Alarm relay	250 V ~3 A, 700 VA contact type, changeover
Interfaces	LAN, SD-expansion slot
Electrical connection	100...240 V~, 50/60 Hz
Permissible ambient temperature	-5...45 °C
Storage temperature	-10...70 °C
Enclosure rating	IP 65
Climate	Permissible relative humidity: 95% non-condensing DIN IEC 60068-2-30
Dimensions H x W x D	227 x 342 x 78 mm

Compliance of all devices with CANopen specifications:

On the hardware side, all devices comply with the harmonised CAN specification 2.0 (ISO99-1, ISO99-2). This includes the CAN protocol (ISO 11898-1) and details on the physical layer in compliance with ISO 11898-2 (high speed CAN up to 1 Mbit/sec) and ISO 11898-3 (low speed CAN up to 125 kBit/sec). The unit complies with the CAN-Open specification CiA-DS401 that forms the basis of the European standard EN50325-4 and also complies with the controller device profile CiA-404.

2.4 Multi-Channel Multi-Parameter Measuring and Control System DULCOMARIN® II

2.4.2 Controller DULCOMARIN® II

The DULCOMARIN® II multi-channel measuring and control system is suitable for 1 to 16 filtration circuits or potable water systems. The following bus modules are available for the control:

M module (measurement and control):

- Measurement and control of the pH value
- Measurement and display (optional control) of the ORP
- Measurement and display of the temperature of the sample water
- Sample water monitoring
- Measurement of free chlorine
- Measurement of combined chlorine (optional, calculated from total chlorine and free chlorine)

Chlorine sensors:

- Measurement of free chlorine and temperature
- Measurement of total available chlorine and temperature
- Measurement of combined chlorine as differential chlorine measurement

A module (control of metering pumps, analogue outputs):

- 3 frequency outputs to control metering pumps for pH correction, disinfection and flocculant metering
- 3 contact inputs to process pump alarm relays or tank fill level monitoring
- 4 freely programmable analogue outputs 0/4...20 mA for pH, ORP, free chlorine, combined chlorine or temperature

P module (controlling of peristaltic pumps, power supply of bus modules):

- Power relay pulse length control for pH value (e.g. control of the peristaltic pump)
- Power relay pulse length control of disinfectant (e.g. control of the chlorine electrolysis plant)
- Power relay limit value output to minimise combined chlorine
- Alarm relay
- Power supply of bus modules

N module (power supply of bus modules):

- Power supply of bus modules with no further function

R module (control of the chlorine gas metering units):

- Control of a chlorine gas metering unit and processing of a position feedback potentiometer (0...10 kΩ) (only possible as external module)

Metering pumps with CANopen interface of type Beta®, delta®, Sigma/ 1, Sigma/ 2, and Sigma/ 3

- Direct connection to the bus
- When using Beta/4aCANopen metering pumps, the A module is not required (provided no current outputs are required).

I module (current input module)

- 2 active/passive current inputs (e.g. for the connection of 2-wire transmitters)
- 1 passive current input (e.g. for the connection of a magnetic-inductive flow meter)
- 2 digital inputs for sample water alarm and pause control
- 1 channel with controller function





2.4 Multi-Channel Multi-Parameter Measuring and Control System DULCOMARIN® II

F module (functional module)

The F module consolidates functions and also extends these functions

The following functions can be provided by the F module (you can find details on this in the individual application examples in the assembly and operating instructions):

- Control of circulation operation (depending on the weekday and the time of day)
- Automatic backwashing (depending on the weekday and the time of day)
- Discharge of first filtrate
- Lowering of the water level during idle operation
- Circulation flow control (Flow Control)
- IO module for SoftPLC
- Water level control
- Sample water valve
- Heating function
- Gutter cleaning function
- Attractions
- Flow control
- Control variables

PROFIBUS®-DP V1 gateway

Modbus RTU gateway

KNX gateway

SMS, email alarm signalling via mobile phone GPRS/EDGE – LAN router with web server visualisation

2.4 Multi-Channel Multi-Parameter Measuring and Control System DULCOMARIN® II

Configuration example: 1-pool system

The specific example of a measuring and control system for pH, ORP, free chlorine and temperature for a filter circuit consists of the following components (without metering technology):

A Engineering room

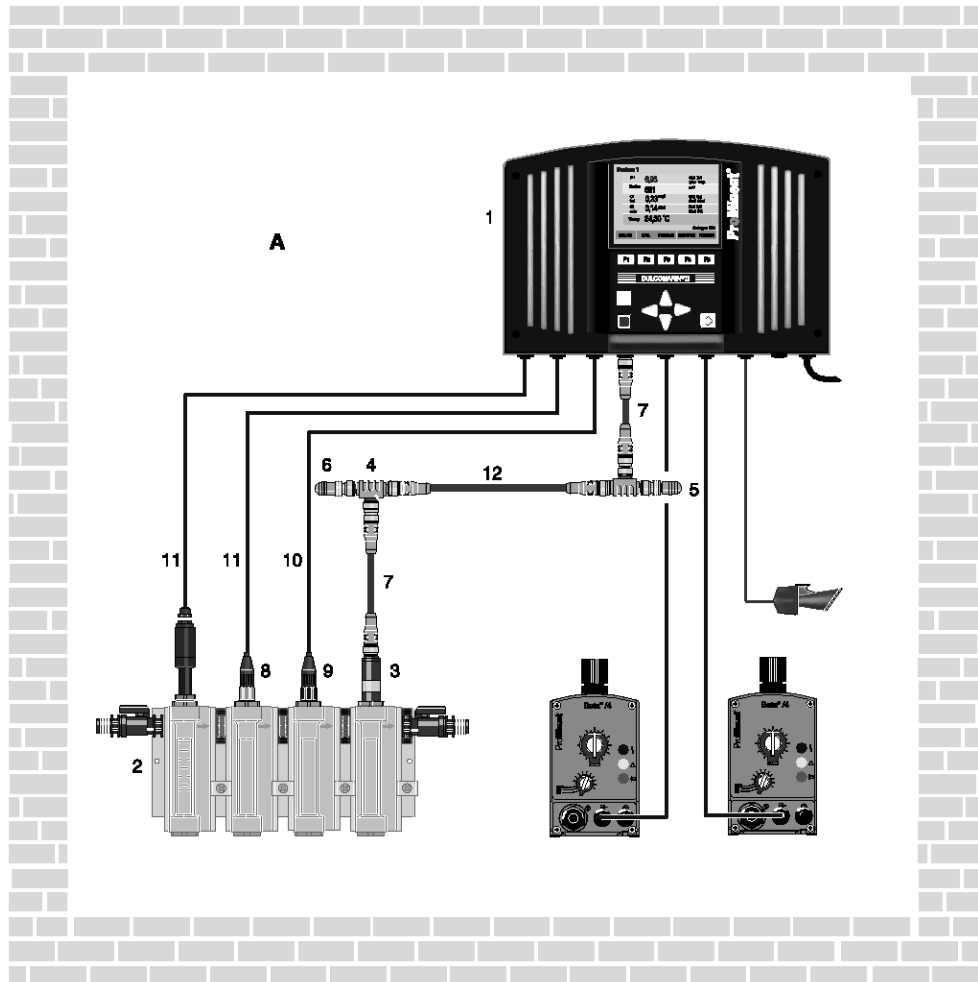

pk_5_020

Item	Quantity	Name	Order no.
1	1	DULCOMARIN® II central unit with measuring and control modules DXCa W 0 0 1 M A P S EN 01	-
2	1	DULCOTEST® in-line probe housing DGMa 3 2 1 T 0 0 0	-
3	1	Chlorine sensor CLE 3-CAN-10 ppm	1023425
4	3	T-distributor M12 5 pol. CAN	Included in delivery
5	1	Termination resistance M12 connector	Included in delivery
6	1	Termination resistance M12 plug	Included in delivery
7	3	Connection cable - CAN M12 5 way 0.5 m	Included in delivery
8	1	pH sensor PHES 112 SE	150702
9	1	ORP sensor RHES-Pt-SE	150703
10	2	Cable combination coaxial Ø 5 mm 2 m - SN6 - pre-assembled	1024106
11	2 m	Two-wire measuring line 2 x 0.25 mm ² Ø 4 mm	725122
12	-	Connecting cable - CAN, sold by the metre	1022160





2.4 Multi-Channel Multi-Parameter Measuring and Control System DULCOMARIN® II

Example 2

The specific example of a measuring and control system for pH, ORP, free and combined chlorine and temperature for a filter circuit consists of the following components (without metering technology):

A Engineering room

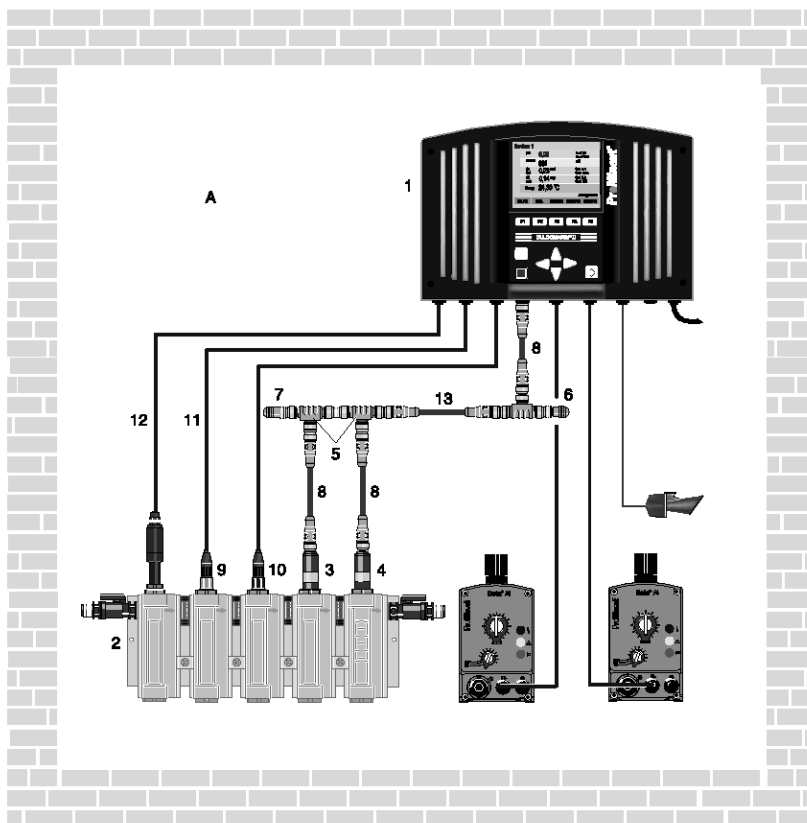

pk_5_020_1

Item	Quantity	Name	Order no.
1	1	DULCOMARIN® II central unit with measurement and actuation modules DXCa W 0 0 1 M A P S EN 01	-
2	1	DULCOTEST® in-line probe housing DGMa 3 2 2 T 0 0 0	-
3	1	Chlorine sensor CTE 1-CAN-10 ppm	1023427
4	1	Chlorine sensor CLE 3.1-CAN-10 ppm	1023426
5	3	T-distributors M12 5 pole CAN	Included in delivery
6	1	Load resistor M12-coupler	Included in delivery
7	1	Load resistor M12-plug	Included in delivery
8	3	Connecting cable - CAN M12 5 pole 0.5 m	Included in delivery
9	1	pH sensor PHES 112 SE	150702
10	1	ORP sensor RHES-Pt-SE	150703
11	2	Cable combination coaxial Ø 5 mm 2 m - SN6 - pre-assembled	1024106
12	2 m	Two-wire measuring line 2 x 0.25 mm ² Ø 4 mm	725122
13	1	CAN Connection cable	As required

2.4 Multi-Channel Multi-Parameter Measuring and Control System DULCOMARIN® II

2.4.3 Identity Code Ordering System DULCOMARIN® II

DULCOMARIN®II DXC serie

DXCa	Installation	
	W	Wall mounting (IP 65)
	S	Control cabinet (IP 54)
	Version	
	0	With operating elements
	D	with operating elements, for use in potable water/disinfection applications
	Communication interfaces	
	0	None
	5	Embedded web server, LAN including 5 m LAN patch cable 1:1, LAN coupling, 5 m crossover cable ¹⁾
	6	OPC server + embedded web server, LAN including 5 m LAN patch cable 1:1, LAN coupling, 5 m crossover cable ¹⁾
	Option (the corresponding communications modules are required, see accessories)	
	0	None
	1	Videographic recorder with data logger including SD card and USB card reader for PC
	2	SoftPLC function (communication option 5 or 6 needed)
	3	KNX function (communication option 5 or 6 needed)
	4	Alarm signalling via text, e-mail (communication option 5 or 6 needed)
	5	SoftPLC function + KNX function + alarm signalling via text, e-mail (communication option 5 or 6 needed)
	6	SoftPLC function + alarm signalling via text, e-mail (communication option 5 or 6 needed)
	7	SoftPLC function + KNX function (communication option 5 or 6 needed)
	8	KNX function + alarm signalling via text, e-mail (communication option 5 or 6 needed)
	Module 1	
	M	M module, measuring module for pH, ORP, temperature
	A	A module, control module: 3 pump and 4 analogue outputs
	I	I module, current input module, 3 mA, 2 digital inputs
	Module 2	
	0	Not used
	A	A module, control module: 3 pump and 4 analogue outputs
	M	M module, measuring module pH, ORP, temperature
	I	I module, current input module, 3 mA, 2 digital inputs
	F	F module, module for filter and attraction control
	Module 3	
	P	P module, mains power module, 1 alarm relay, 3 solenoid valve relays
	N	N module, mains power module without relay
	1	F module occupies module position 3
	Application	
	S	Swimming pool
	D	Potable water/disinfection
	Language default	
	00	no operation
	DE	German
	EN	English
	ES	Spanish
	FR	French
	IT	Italian
	PL	Polish
	NL	Dutch
	CZ	Czech
	Approvals	
	01	CE mark

The identity code describes the **DULCOMARIN® II** controller.

- ¹⁾ The supplied cable is for connection to a hub, switch, router or an intranet.
 For direct connection of the DULCOMARIN® II to a PC/MAC, the supplied LAN coupling and category 5 cross-over cable are required.
 The maximum LAN cable length is approximately 100 m.
 To operate the web server on a PC we recommend Microsoft® Internet Explorer 5 or higher as the browser.
 The scope of supply of the DXCa includes:
 1 T-coupler, 1 CAN connection cable
 1 terminating resistance coupling and
 1 terminating resistance plug,
 1 SD card, 1 card reader suitable for PCs.

Important note when ordering multi-channel measuring and control systems for potable water and pool water applications:

Potable water applications: In the identity code, a "D" for "Potable water/disinfection" must be selected under "Version" and "Application". The description "System" will appear in the controller menu for the different potable water lines.



2.4 Multi-Channel Multi-Parameter Measuring and Control System DULCOMARIN® II

Swimming pool water applications: In the identity code, a "0" for "with operating elements" must be selected under "Version" and then an "S" for "Swimming pool" under "Application". The description "Tank" will appear in the controller menu for the different filter circuits.

All adjustment options and the use of the different modules are identical with both applications.



2.4 Multi-Channel Multi-Parameter Measuring and Control System DULCOMARIN® II

2.4.4

Multi-Channel Multi-Parameter Measuring and Control System DULCOMARIN® II

The multi-channel multi-parameter measuring and control system DULCOMARIN® II DULCO® Net can, in its top-of-the-range optional version, control 16 potable water systems/filtration circuits, i.e. the necessary external modules for 16 tanks can be connected to and operated by the central unit. The following options are available

Measurement and control of:

Up to 16 times:

- pH value
- ORP potential
- Free chlorine
- Combined chlorine (calculated)
- Temperature of the sample water

Also in potable water applications (using the I module):

- Flow (as disturbance variable for pH and chlorine control)
- UV intensity
- Conductivity
- Chlorine dioxide
- Chlorite
- Ammonia
- Fluoride
- Pt100/Pt1000 resistance thermometer via a transducer

Other inputs and outputs:

Up to 16 times:

- 3 frequency outputs for control of metering pumps for pH-correction, disinfectant and flocculent metering
- 3 contact inputs for processing of pump fault signal relays or container level monitoring
- 4 freely programmable analogue outputs 0/4 ... 20 mA (for pH, ORP, free chlorine, combined chlorine or temperature)
- 3 output relays pulse length control of the pH value, the disinfectant and minimisation of the combined chlorine (e.g. control of a peristaltic pump and chlorine electrolysis system and UV system)
- Control of a chlorine gas metering device
- 3 Beta®/4 CANopen metering pumps
- Up to 2 F modules per filter circuit are possible

The CAN bus with CANopen protocol is used as a data transfer medium between the various bus modules. This extremely interference-proof technology was developed by Bosch and is well known from its use in automotive applications. The maximum length of the bus backbone is 400 metres.

A T-coupler is used for connection of one of each bus module (M module, A module, P module, N module, Beta® 4 CANopen metering pumps and CAN chlorine sensors), which connects the devices to the bus backbone via a branching cable.

T-coupler and branching cable are part of the scope of supply of the modules.

All bus modules are supplied via the CAN bus with 24 V operating voltage (with the exception of Beta®/4 CANopen metering pumps, P modules, N modules. These require a separate mains voltage supply).

For this reason, depending on the size of the installation (number of filtration circuits to be controlled), additional P or N modules are required that feed the operating voltage for the bus modules into the bus. The central unit always contains a power supply (N or P module).

How many additional N or P modules do you require?

Number of filtration circuits	Additional N or P modules	Number of filtration circuits	Additional N or P modules
1	–	9	4
2	–	10	5
3	1	11	5
4	2	12	6
5	2	13	6
6	3	14	7
7	3	15	7
8	4	16	8



2.4 Multi-Channel Multi-Parameter Measuring and Control System DULCOMARIN® II

The DULCOMARIN® II can be easily extended by the connection of bus modules.

Which components can a DULCOMARIN® II system comprise?

A DULCOMARIN® II DULCO® Net system comprises:

- DXCa central unit with operating elements

and a customised combination of the following components:

- M module, DXMaM (measuring and control)
- A module, DXMaA (control of metering pumps, analogue outputs)
- P module (module in the DXCa housing for power supply to the modules and alarm relays, output relays for control of, for example, peristaltic pumps)
- N module, DXMaN (power supply to external modules with no other function)
- R module, DXMaR (control of chlorine gas metering devices with response signal processing)
- I module (processing of sensor signals via 0/4...20 mA)
- F module (filter and attraction control)

The maximum bus backbone length is approximately 400 m!



2.4 Multi-Channel Multi-Parameter Measuring and Control System DULCOMARIN® II

2.4.5 Central Unit

- A Stub cable
- B Main BUS cable
- C Stub cable

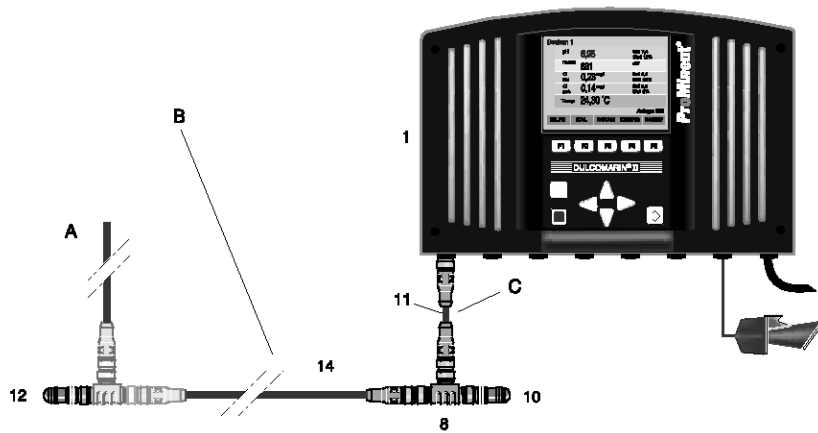

pk_5_041_2

The central unit can be installed anywhere, for example in the control room. It serves as an I/O unit (view measuring data, parameterise and configure individual modules). It includes the following functions: standard screen recorder/data logger function, interfaces*, embedded Web server* and power supply. As an option, the central unit can also include an M and an A module if the central unit is also located in the control room. The central unit is connected to other units via the main bus train.

For this connection, the T-distributor and the CAN connecting cable 0.5 m included in the scope of delivery are used.

The main bus train must be fitted with termination resistors at either end.

These components are included in the scope of delivery.

The central unit in the above example consists of the following components:

Item	Quantity	Name	Order no.
1	1	DULCOMARIN® II central unit DXCa W 0 0 1 0 0 P S EN 01	-
8	1	T-distributor M12 5 pol. CAN	Included in delivery
11	1	Connection cable - CAN M12 5 way 0.5 m	Included in delivery
14	1	CAN Connection cable	As required
10	1	Termination resistance M12 connector	Included in delivery
12	1	Termination resistance M12 plug	Included in delivery

* optional



2.4 Multi-Channel Multi-Parameter Measuring and Control System DULCOMARIN® II

2.4.6 Combination Module

- A Stub cable
- B Main BUS cable

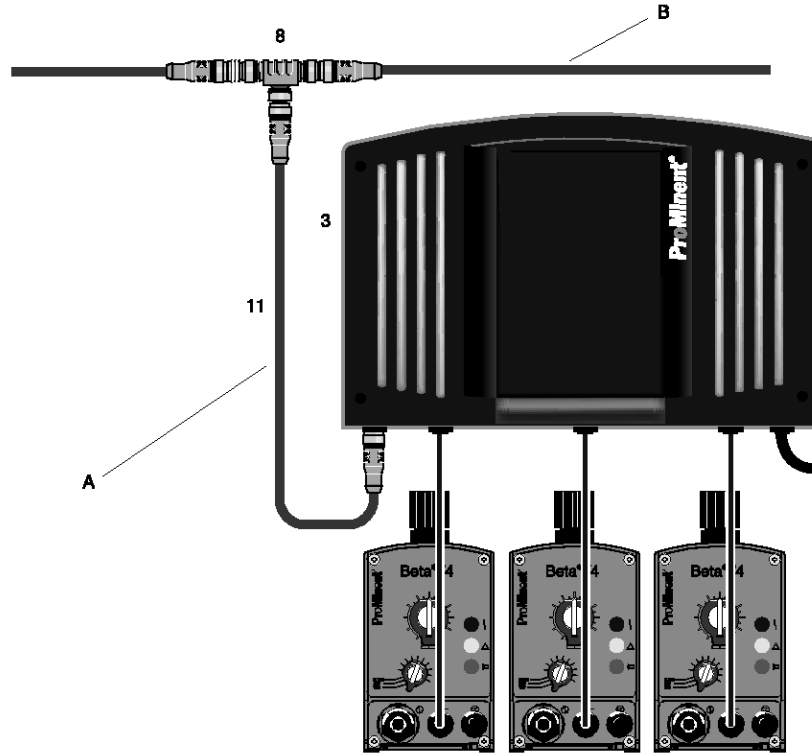

pk_5_044

Combination of M, A, I-module and F, P, N module

Up to three different modules can be accommodated by the combination module (DXCa without control elements). The function of the combination module results from the function of the individual modules (see above description). The modules in the combination module are operated via the DXCa central unit.

The module is connected to other bus modules via the main bus line.

See the table below for the various equipment options.

Module position 1	Module position 2	Module position 3
M, A, I module	M, A, I module	P, N module
M, A, I module	F module	Occupied by the F module

The combination in the above example consists of the following components (without chemical fluid handling):

Item	Quantity	Name	Order no.
3	1	Control module DXCa W 2 0 0 0 A P S 00 01	-
8	1	T-distributor M12 5 pol. CAN	Included in delivery
11	1	Connection cable - CAN M12 5 way 0.5 m	Included in delivery



2.4 Multi-Channel Multi-Parameter Measuring and Control System DULCOMARIN® II

2.4.7 Functional Module (F Module)

- A Stub line
B Bus main string

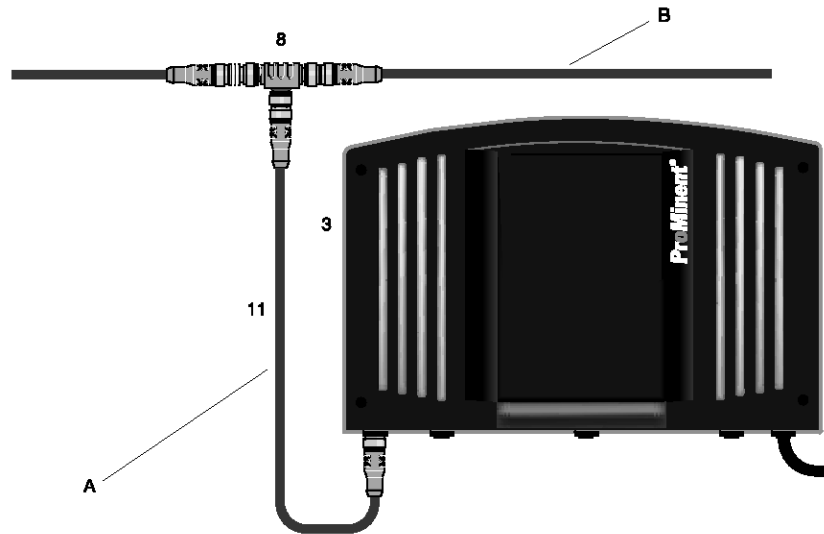

P_DC_0009_SW

The F module combines functions that were until now available in the A and P module combination and also extends these functions. It includes the supply voltage (90 – 253 VAC) for the controller. The F module is selected for the 2nd module position and also occupies the 3rd module position. The following functions can be provided by the F module (you can find details for this in the individual application examples in the assembly and operating instructions). The F module also acts as an input/output module for the SoftPLC.

Hydraulic functions:

- Control of circulation operation (depending on the weekday and the time of day)
- Automatic backwashing
- Route first filtrate through the internal circuit (electrical backflow shut-off valve)
- Lowering of the water level during idle operation
- Circulation flow control
- Water level control
- Sample water valve
- Heating function
 - Heating control heat exchanger
 - Solar heating
- Gutter cleaning function

Attractions:

- Open/Close cover
- Counterflow system/JetStream
- Flood/Neck shower
- Massage nozzle
- Underwater light

Monitoring:

- Flow control
 - Current circulation flow recording
 - Fresh water top-up recording
 - Cover
 - Massage pump active
 - 1, 2 or 4-stage level functions
- Control variables for:
 - Disinfection
 - pH (+/-)
 - Flocculation
 - UV system
 - Backwashing emergency-off, if water alarm emitted





2.4 Multi-Channel Multi-Parameter Measuring and Control System DULCOMARIN® II

2.4.8 Identity Code Ordering System Multi-Channel Multi-Parameter Measuring and Control System DULCOMARIN® II (Central Unit and Combination Module)

DXCa		Installation	
W		W	Wall mounting (IP 65)
S		S	Control cabinet (IP 54)
		Version	
0		0	With operating elements
2		2	Without operating elements
D		D	With operating elements, for use in potable water/disinfection applications
		Communication interfaces	
0		0	None
5		5	Embedded web server, LAN including 5 m LAN patch cable 1:1, LAN coupling, 5 m crossover cable
6		6	OPC server + embedded web server, LAN including 5 m LAN patch cable 1:1, LAN coupling, 5 m crossover cable
		Option (the corresponding communications modules are required, see accessories)	
0		0	none
1		1	Videographic recorder with data logger including SD card and USB card reader for PC
2		2	SoftPLC function (communication option 5 or 6 needed)
3		3	KNX function (communication option 5 or 6 needed)
4		4	Alarm signalling via text, e-mail (communication option 5 or 6 needed)
5		5	SoftPLC function + KNX function + alarm signalling via text, e-mail (communication option 5 or 6 needed)
6		6	SoftPLC function + alarm signalling via text, e-mail (communication option 5 or 6 needed)
7		7	SoftPLC function + KNX function (communication option 5 or 6 needed)
8		8	KNX function + alarm signalling via text, e-mail (communication option 5 or 6 needed)
		Module 1	
0		0	Not used
M		M	M module, measuring module: pH, ORP, temperature
A		A	A module, control module: 3 pump and 4 analogue outputs
I		I	I module, current input module, 3 mA inputs, 2 digital inputs
		Module 2	
0		0	Not used
A		A	A module, control module: 3 pump and 4 analogue outputs
M		M	M module, measuring module: pH, ORP, temperature
I		I	I module, current input module, 3 mA inputs, 2 digital inputs
F		F	F module, module for filter and attraction control
		Module 3	
P		P	P module, mains power module, 1 alarm relay, 3 solenoid valve relays
N		N	N module, mains power module unit without relay
1		1	F module occupies module position 3
		Application	
S		S	Swimming pool
D		D	Potable water/disinfection
		Language default	
DE		DE	German
EN		EN	English
ES		ES	Spanish
FR		FR	French
IT		IT	Italian
PL		PL	Polish
NL		NL	Dutch
CZ		CZ	Czech
		Approvals	
01		01	CE mark

Please note the following!

Upgrade modules for existing systems require a software update for the existing system. A Software Update Kit is needed to avoid any possible incompatibility between the different modules.

The update kit is free of charge and one is also needed when ordering more than one upgrade module. The kit includes an SD memory card with the current software for the DULCOMARIN® II and a description about how to perform the software update.

	Order no.
Update kit/DXC and modules	1031284

The Identity code describes the complete **DULCOMARIN®II DULCO®-Net** central unit.

The peripheral components mentioned in the above item list, however, are not included. If modules are assigned to the central unit, the following applies:

Module 1 preferably assigned as M module

Module 2 preferably assigned as A module

Module 3 must always be assigned as P module or N module.

2.4 Multi-Channel Multi-Parameter Measuring and Control System DULCOMARIN® II

Important note when ordering multi-channel measuring and control systems for potable water and pool water applications:

Potable water applications: In the identity code, a "D" for "Potable water/disinfection" must be selected under "Version" and "Application". The description "System" will appear in the controller menu for the different potable water lines.

Swimming pool water applications: In the identity code, a "0" for "with operating elements" must be selected under "Version" and then an "S" for "Swimming pool" under "Application". The description "Tank" will appear in the controller menu for the different filter circuits.

All adjustment options and the use of the different modules are identical with both applications.



2.4 Multi-Channel Multi-Parameter Measuring and Control System DULCOMARIN® II

2.4.9 Measuring Module (M module)

- A Stub cable
B Main BUS cable

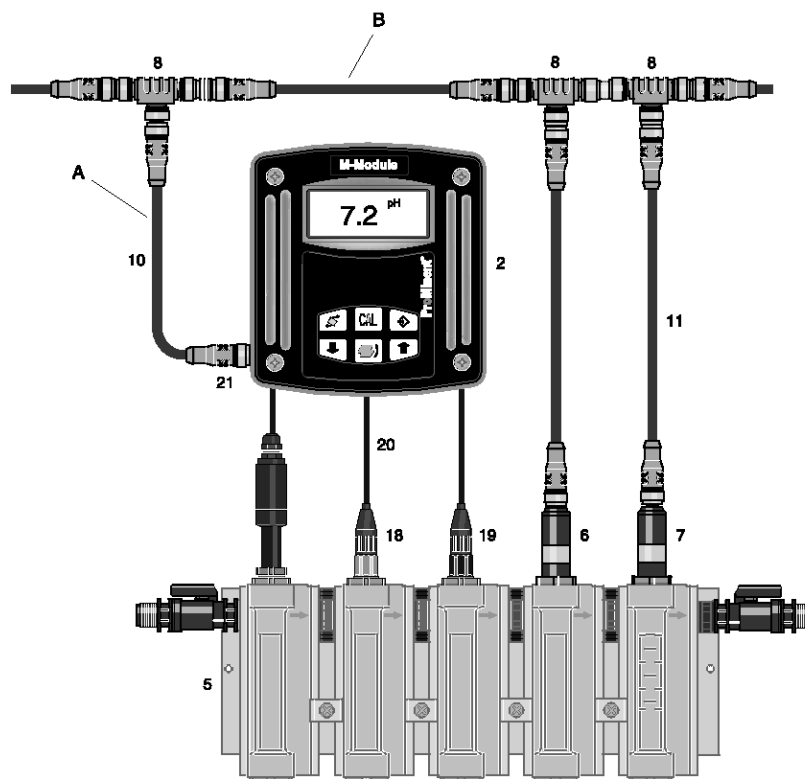

pk_5_042

The M module with its illuminated graphic display and keypad displays the measured values and allows all sensors for the corresponding filter circuit to be calibrated on site.

The following measurements can be taken:

- pH value
- ORP potential
- Free chlorine and
- Total available chlorine (optional or combined chlorine is calculated) and
- Sample water temperature using the temperature probe in the chlorine sensor or optionally using a separate Pt100/Pt1000 resistance thermometer

The M module has 3 digital inputs for:

- Sample water monitoring
- Controlling breaks in filter backwashing
- Parameter changeover for Eco!Mode

The M module is connected to the other bus modules via the main bus cable, using the T-distributor supplied and the 0.5 m CAN connection cable.

The M module in the above example consists of the following components:

Item	Quantity	Name	Order no.
2	1	M module DXMa M W 0 S EN 01	DXMa M W 0 S EN 01
5	1	In-line probe housing DGMa 3 2 2 T 0 0 0	DGMa 3 2 2 T 0 0 0
6	1	Chlorine sensor CTE 1-CAN-10 ppm	1023427
7	1	Chlorine sensor CLE 3.1-CAN-10 ppm	1023426
8	3	T-distributor M12 5 pole CAN	Included in delivery
10	1	Connection cable - CAN M12 5-pole 0.5 m	Included in delivery
11	2	Connection cable - CAN M12 5-pole 0.5 m	Included in delivery
18	1	pH sensor PHES 112 SE	150702
19	1	ORP sensor RHES-Pt-SE	150703
20	2	Cable combination coaxial Ø 5 mm 2 m - SN6 - pre-assembled	1024106
21	2 m	Two-wire measuring line 2 x 0.25 mm ² Ø 4 mm	725122



2.4 Multi-Channel Multi-Parameter Measuring and Control System DULCOMARIN® II

2.4.10 Current Input Module (I module)

- A Stub cable
- B Main BUS cable

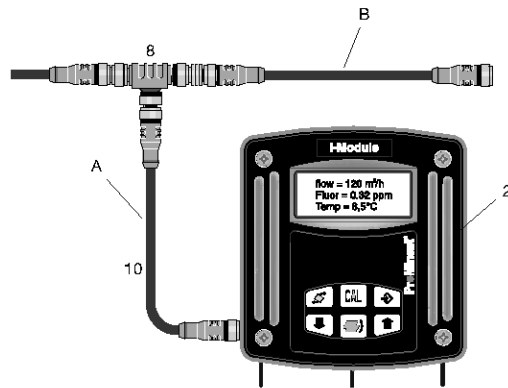

AP_DC_0011_SW

This I module with its illuminated graphic display and keypad is a current input module capable of processing 3 standard signals from sensors and two digital signals.

It can be used together with the multi-channel controller DULCOMARIN® II in potable water and swimming pool applications. All measured variables are available in the screen plotter and web and OPC® server.

Two analogue inputs are provided as 2-wire inputs and one as passive input. All channels have pre-selected measured variables. However the identifier and units can also be edited. Channel 1 acts as an interference variable channel for channel 2. Channel 3 acts as the temperature compensation channel for channel 2 when the measured variable is fluoride. Channel 2 has a control function.

The inputs can process the following values as 0/4... 20 mA standard signals:

- Turbidity
- Flow (can also be used as the disturbance variable)
- UV intensity
- Conductivity (via DMTa transmitter)
- Chlorine dioxide
- Chlorite
- Ammonia
- Fluoride
- Pt100 resistance thermometer via a transducer
- Dissolved oxygen
- Hydrogen peroxide
- Editable designation and unit for all 3 channels

The I module has 2 digital inputs for:

- Sample water monitoring and
- Pause control

The flow information can be used as a disturbance variable for the control of chlorine, pH correction and chlorine dioxide.

The I module is connected to other bus modules via the main bus cable using the T-distributor and 0.5 m CAN connection cable supplied as part of the delivery.

The I module in the above example consists of the following components:

Item	Quantity	Name	Order no.
2	1	I module DXMa I W 0 D EN 01	–
8	1	T-distributor M12 5P CAN	Included in delivery
10	1	Connecting cable - CAN, M12, 5P, 0.5 m	Included in delivery



2.4 Multi-Channel Multi-Parameter Measuring and Control System DULCOMARIN® II

2.4.11 Control Module (A module)

- A Stub cable
- B Main BUS cable

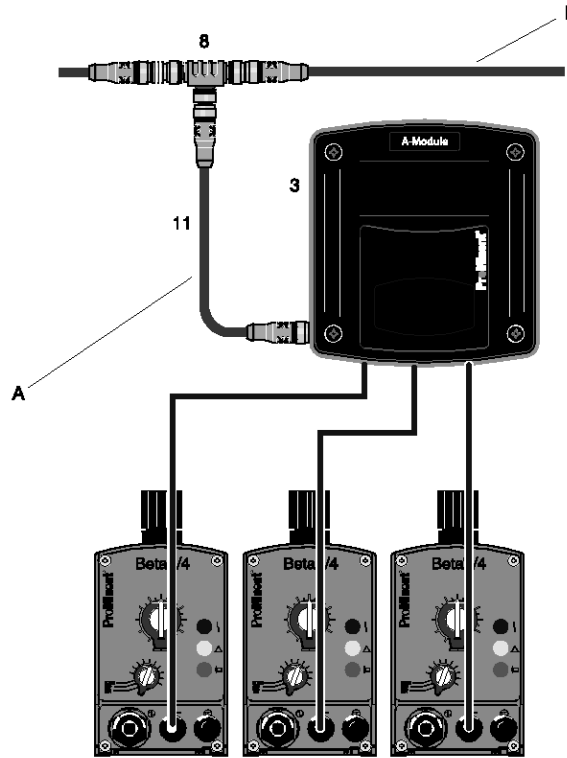

pk_5_043

The A module permits the control of up to three metering pumps via pulse frequency. Possible metering combinations are:

- pH lowering and disinfectant and flocculant or
- pH raising and disinfectant and flocculant or
- pH lowering and pH raising and disinfectant

It includes 3 digital inputs to evaluate the alarm relay of metering pumps, 4 freely programmable standard signal outputs 0/4...20 mA to document measured values, or as control outputs.

The T-distributor and 0.5 m CAN connecting cable included in the scope of delivery are used for this connection.

Note: No A modules are required if Beta®/4CANopen metering pumps are used!

The A module in the above example consists of the following components (without metering technology):

Item	Quantity	Name	Order no.
3	1	A module DXMa A W 2 0 00 01	–
8	1	T-distributor M12 5 pol. CAN	Included in delivery
11	1	Connection cable - CAN M12 5 way 0.5 m	Included in delivery

The A module is connected to other units via the main bus train.

An isolating amplifier, e.g. order no. 1033536 is required for connection to units which are not electrically isolated (e.g. PLC)!



2.4 Multi-Channel Multi-Parameter Measuring and Control System DULCOMARIN® II

2.4.12 Power Supply Module (N module)

- A Stub cable
- B Main BUS cable

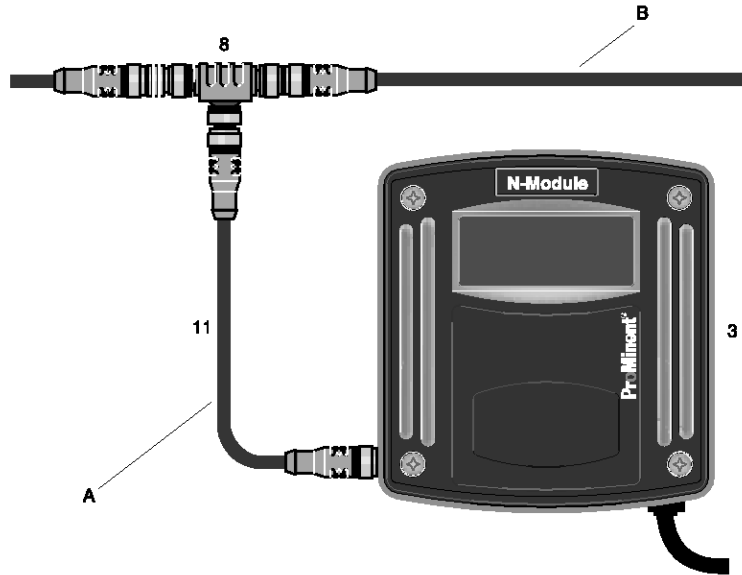

pk_5_043_C_power

The N module (power supply) is used to supply the bus modules with power and has no further function.

The number of N modules required can be seen from the table below. If P modules are used in a system, the number of N modules is reduced accordingly. The central unit always includes a power supply unit (N or P module)

How many additional N or P modules do you require?

Number of filtration circuits	Additional N or P modules	Number of filtration circuits	Additional N or P modules
1	-	9	4
2	-	10	5
3	1	11	5
4	2	12	6
5	2	13	6
6	3	14	7
7	3	15	7
8	4	16	8

The N module requires a power supply for operation and is connected to the other bus modules via the main bus train. The T-distributor and 0.5 m CAN connecting cable included in the scope of delivery are used for this connection.

The N module in the above example consists of the following components:

Item	Quantity	Name	Order no.
3	1	N module DXMa N W 2 0 00 01	-
8	1	T-distributor M12 5 pol. CAN	Included in delivery
11	1	Connection cable - CAN M12 5 way 0.5 m	Included in delivery

Our Sales department would be glad to assist with any questions you may have.



2.4 Multi-Channel Multi-Parameter Measuring and Control System DULCOMARIN® II

2.4.13 Control Module for Chlorine Gas Metering Devices (R module)

- A Stub cable
- B Main BUS cable

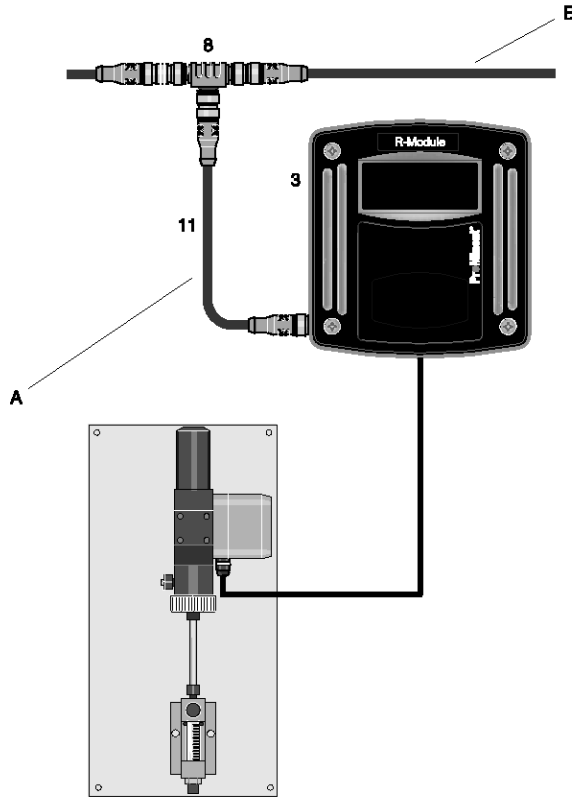

pk_5_043_C

The R module permits the control of chlorine gas metering units equipped with a position feedback potentiometer.

It includes 2 power relays for opening and closing and an input for a position feedback potentiometer 1 ... 10 kΩ

The R module is connected to other units via the main bus train.

The T-distributor and 0.5 m CAN connecting cable included in the scope of delivery are used for this connection.

The R module in the above example consists of the following components (without the chlorine gas metering device):

Item	Quantity	Name	Order no.
3	1	R module DXMa R W 2 0 00 01	-
8	1	T-distributor M12 5 pol. CAN	Included in delivery
11	1	Connection cable - CAN M12 5 way 0.5 m	Included in delivery

Our Sales department would be glad to assist with any questions you may have.



2.4 Multi-Channel Multi-Parameter Measuring and Control System DULCOMARIN® II

2.4.14 Limit Value and Alarm Module (G module)

- A Stub cable
- B Bus main cable

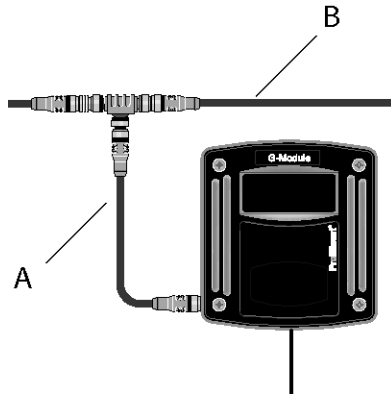

P_DM_0024_SW3

The G-module is a limit value and alarm emitting module with 2 potential-free changeover relays to signal alarm states. Each of the two relays has ten different setting options to monitor measured values for minimum and maximum values and, should the values exceed or fall below these limits, this then triggers the relay. Both relays have the same setting options, thereby enabling signals for pre-warnings or shutdowns to be generated by the use of different delay periods.

The G module is connected to the other units via the main bus cable using the T-distributor and 0.5 m CAN connection cable supplied.

The G module in the above example consists of the following components:

Item	Quantity	Name	Order no.
3	1	G module DXMa G W 2 0 00 01	–
8	1	T-distributor M12 5 pol. CAN	Included in delivery
11	1	Connection cable - CAN M12 5 way 0.5 m	Included in delivery

Our Sales department would be glad to assist with any questions you may have.



2.4 Multi-Channel Multi-Parameter Measuring and Control System DULCOMARIN® II

2.4.15 Identity Code Ordering System for CANopen Modules

Modules for the DULCOMARIN® II, DXM serie

DXMa	Module
M	M module, measuring module: pH, ORP, temperature
A	A module, control module: 3 pump and 4 analogue outputs
R	R module, control module: chlorine gas metering unit with feedback ^{1), 2)}
N	N module, mains power module without relay ^{1), 2)}
P	P module, mains power module with relay, only mounting type "0" ^{1), 2)}
I	I module, current input module, 3 mA inputs, 2 digital inputs
Installation	
0	No housing, only P module (IP 00)
W	Wall mounting (IP 65)
E	Retrofit module (installation module for DXCa, IP 20)
Version	
0	With controls (only M module, mounting type W) ¹
2	Without controls
3	Without controls (only mounting type "E")
Application	
0	Standard
S	Swimming pool (only M-module)
D	Potable water/disinfection (only I module)
Language default	
00	No controls ²⁾
DE	German
EN	English
ES	Spanish
FR	French
Approvals	
00	No approval, only P-module without housing
01	CE mark

Please note the following:

Upgrade modules for existing systems require a software update for the existing system. A Software Update Kit is needed to avoid any possible incompatibility between the different modules.

The update kit is free of charge and one is also needed when ordering more than one upgrade module. The kit includes an SD memory card with the current software for the DULCOMARIN® II and a description about how to perform the software update.

	Order no.
Update kit/DXC and modules	1031284



2.4 Multi-Channel Multi-Parameter Measuring and Control System DULCOMARIN® II

2.4.16 Spare Parts and Upgrade Sets

Internal spare parts and upgrade sets for the DULCOMARIN® II cannot be ordered using the part number printed on the modules!

Modules have to be fully replaced (the exception to this is the N module).

The electrical unit for the central unit can only be replaced by a complete processor spare part.

Please use only the following identity codes when ordering:

Replacement central units

- Replacement central unit: DXCAC001000#DE01 (without communication interface, # = please state "S" for applications in swimming pools and "D" for applications relating to potable water).
- Replacement central unit: DXCAC051000#DE01 (with web server, # = please state "S" for applications in swimming pools and "D" for applications relating to potable water).
- Replacement central unit: DXCAC061000#DE01 (with OPC and web server, # = please state "S" for applications in swimming pools and "D" for applications relating to potable water).

External modules (replacement or upgrade modules):

- M module: DXMa M W 0 S EN 01 (with display)
- A module: DXMa AW2 0 00 01 (without display)
- N module: DXMa N W 2 0 00 01 (without display)
- R module: DXMa R W2 0 00 01 (without display)
- G module: DXMa G W2 0 00 01 (without display)
- P module: DXCa W 2 00 00 PS 00 01 (without display in large DXC housing)
- I module: DXMa I W 0 D D E 01 (with display)
- I module: DXMa I W 2 D 0 0 0 1 (without display)

Internal modules (replacement or upgrade modules):

- M module: DXMa M E3S 00 01
- A module: DXMa A E30 00 01
- P module: DXMa P03 00 00
- I module: DXMa I E 3 D 00 01
- N module: Order no. 732485, electrical set DXMaN 24 V/1A

2.4.17 Retrofit Kits for DULCOMARIN® II DXC

The DULCOMARIN® II can be upgraded in-situ with the web server and OPC server functions. The upgrade is implemented by entry of an activation key. The activation key can be entered either manually via the keyboard into the DULCOMARIN® II or via an SD card. The SD card is supplied.

The following information is needed to determine the device-specific activation codes:

- 1 Serial number and software version of the DULCOMARIN® II. This can be found under F1 HELP.
- 2 Current identity code. This can be found under F1 HELP.
- 3 Required upgrade.

	Order no.
DXC retrofit kit on web server, including LAN cable and instructions	1029466
DXC retrofit kit on web server + OPC server, including LAN cable and instructions	1029465
DXC retrofit kit on web server + OPC server, including instructions and OPC CD-ROM	1029467
DXC retrofit kit SoftPLC**	1049734
DXC retrofit kit KNX**	1049735
DXC retrofit kit SMS_EMAIL*	1049736
DXC retrofit kit SoftPLC, KNX, TEXT_EMAIL**	1049737
DXC retrofit kit SoftPLC, TEXT_EMAIL**	1049738
DXC retrofit kit SoftPLC, KNX**	1049739
DXC retrofit kit KNX, TEXT_EMAIL**	1049740

* Order the gateways/routers separately. Communication option 5 or 6 is always needed.

** Available from software version 3030 or higher.



2.4 Multi-Channel Multi-Parameter Measuring and Control System DULCOMARIN® II

2.4.18 Diaphragm Metering Pumps with CANopen Bus Interface

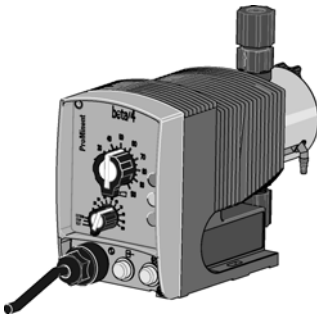

P_BE_0002_SW
Beta®

- CANopen bus interface for DULCOMARIN® II
- Pump capacity 0.2-1,030 l/h
- Stroke length continuously adjustable between 0 - 100% (recommended 30 - 100%)
- Transmission of the stroke length setting from the DULCOMARIN® II
- Material designs PP, clear acrylic/PVC
- Patented coarse/fine bleed valve for PP and clear acrylic/PVC
- Self-bleeding dosing head design in PP and clear acrylic/PVC
- Connector for 2-stage level switch
- Design for low voltage 12-24 V DC, 24 V AC
- 4 LED display for operation, warning and error messages
- Alarm in the event of stroke length changes of $> \pm 10\%$
- Transmission of level alarm without alarm relay via the bus

Diaphragm metering pumps are contained in Volume 1 on the following pages: Solenoid Driven Metering Pump Beta® → 1-7, Solenoid Driven Metering Pump delta® → 1-21.

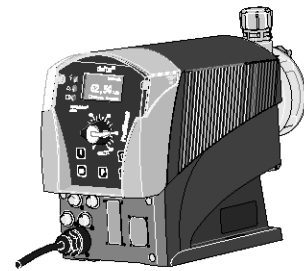

P_DE_0002_SW
delta®

Process metering pumps are contained in Volume 3 on the following pages: Motor Driven Metering Pump Sigma/ 1 (Basic Type) → 1-9, Motor Driven Metering Pump Sigma/ 2 (Basic Type) → 1-29, Motor Driven Metering Pump Sigma/ 3 (Basic Type) → 1-49

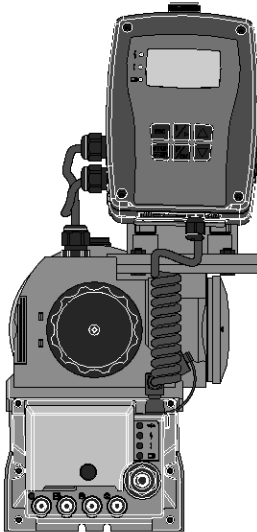

P_SI_0129_SW
Sigma/ 1 control type



2.4 Multi-Channel Multi-Parameter Measuring and Control System DULCOMARIN® II

2.4.19

Solenoid Driven Metering Pumps Beta®

- CANopen bus interface for DULCOMARIN® II
- Feed rate range of 0.74 - 32 l/h, 16 - 2 bar
- Stroke length continuously adjustable between 0 - 100% (recommended 30 - 100%)
- Transmission of the stroke length setting from the DULCOMARIN® II
- Material versions PP, clear acrylic/PVC
- Patented coarse / fine bleed valve for PP and clear acrylic/PVC
- Self-bleeding dosing head version in PP and clear acrylic/PVC
- Connection for 2-stage level switch
- Version for low voltage 12-24 V DC, 24 V AC
- 4 LED display for operation, warning and error messages

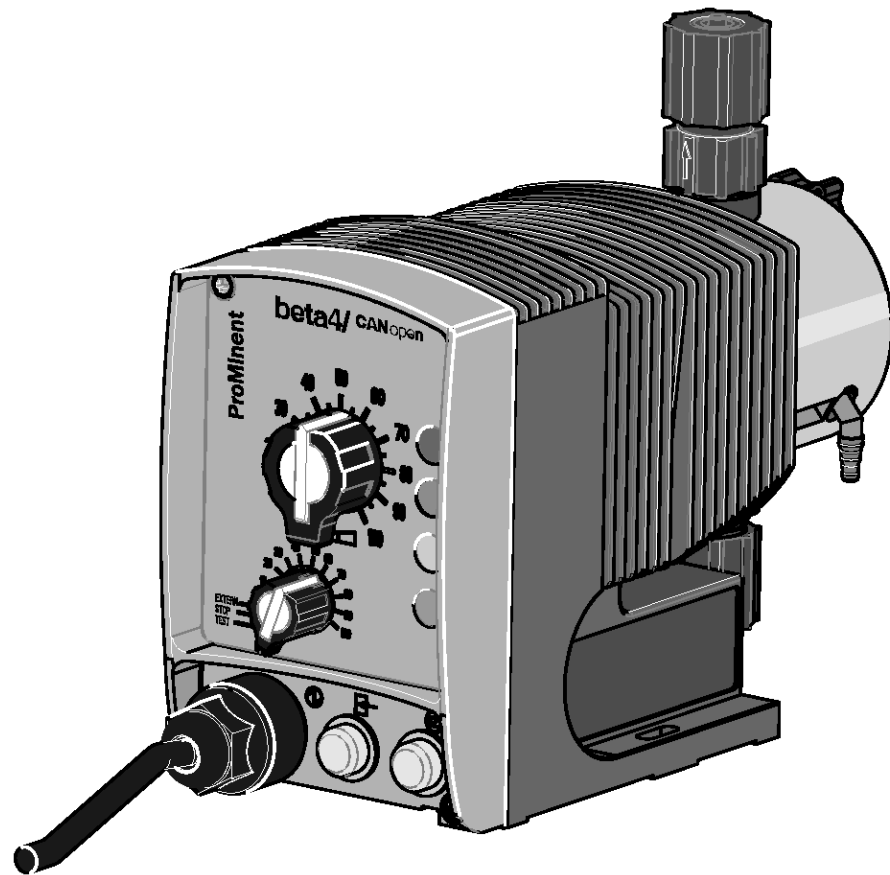

pk_1_004_2



2.4 Multi-Channel Multi-Parameter Measuring and Control System DULCOMARIN® II

Technical Data

Pump type	Delivery rate at max. back pressure			Delivery rate at medium back pressure			Stroke rate Strokes/min	Connection size o Ø x i Ø mm	Suction lift mWC	Shipping weight PP, NP, PV, TT kg
	bar	l/h	ml/stroke	bar	l/h	ml/stroke				
Beta®										
BT4a 1000***	10	0.74	0.07	5.0	0.82	0.08	180	6 x 4	6.0**	2.9
BT4a 1601***	16	1.10	0.10	8.0	1.40	0.13	180	6 x 4	6.0**	2.9
BT4a 1602***	16	2.10	0.19	8.0	2.50	0.24	180	6 x 4	6.0**	2.9
BT4a 1005***	10	4.40	0.41	5.0	5.00	0.46	180	8 x 5****	6.0**	3.1
BT4a 0708***	7	7.10	0.66	3.5	8.40	0.78	180	8 x 5	6.0**	3.1
BT4a 0413	4	12.30	1.14	2.0	14.20	1.31	180	8 x 5	3.0**	3.1
BT4a 0220	2	19.00	1.76	1.0	20.90	1.94	180	12 x 9	2.0**	3.3
Beta® metering pumps with self-bleeding dosing head*										
BT4a 1601	16	0.59	0.06	8.0	0.78	0.07	180	6 x 4	1.8**	2.9
BT4a 1602	16	1.40	0.13	8.0	1.70	0.16	180	6 x 4	2.1**	2.9
BT4a 1005	10	3.60	0.33	5.0	4.00	0.37	180	8 x 5	2.7**	3.1
BT4a 0708	7	6.60	0.61	3.5	7.50	0.69	180	8 x 5	2.0**	3.1
BT4a 0413	4	10.80	1.00	2.0	12.60	1.17	180	8 x 5	2.0**	3.1
BT4a 0220	2	16.20	1.50	1.0	18.00	1.67	180	12 x 9	2.0**	3.3

* The given performance data constitutes assured minimum values, calculated using medium water at room temperature. The bypass connection with a self-bleeding dosing head is 6x4 mm.

** Suction lift with a filled dosing head and filled suction line, for a self-bleeding dosing head with air in the suction line.

*** For special applications, e.g. in the swimming pool sector, pressure-reduced pump types are available in the pressure ratings 4, 7 and 10 bar. More detailed information is available upon request.

**** For stainless steel version 6 mm connector width.

Materials in Contact With the Medium

	Dosing head	Suction/discharge connector	Seals	Valve balls
PPE	Polypropylene	Polypropylene	EPDM	ceramic
PPB	Polypropylene	Polypropylene	FKM	ceramic
NPE	Clear acrylic	PVC	EPDM	ceramic
NPB	Clear acrylic	PVC	FKM	ceramic

Only the self-bleeding version in PP and NPE material versions with a valve spring made of Hastelloy C and a valve insert in PVDF. Metering diaphragm with a PTFE coating.

FKM = Fluorine Rubber

Repeatability of metering $\pm 2\%$ when used according to the operating instructions.

Permissible ambient temperature -10 °C to +45 °C

Mean power consumption Type 1000-0220 17 W
Degree of protection: IP 65, insulation class F

Scope of supply: Metering pump with mains cable (2 m) and plug, connector kit for hose/pipe connection as per table, connecting cable CAN M12 5 pole. 1 m, T-coupler M12 5-pole CAN.

2.4 Multi-Channel Multi-Parameter Measuring and Control System DULCOMARIN® II

Beta® product range, Version a

BT5a	Type	Capacity	
		bar	l/h
	1605	16	4.10
	1008	10	6.80
	0713	7	11.00
	0420	4	17.10
	0232	2	32.00
BT4a			
	1000	10	0.74
	1601	16	1.10
	1602	16	2.10
	1005	10	4.40
	0708	7	7.10
	0413	4	12.30
	0220	2	19.00
Liquid end/valve material			
	PP	Polypropylene/polypropylene	
	NP	Clear acrylic/PVC	
	PV	PVDF/PVDF	
	TT	PTFE/PTFE	
	SS	Stainless steel 1.4404/1.4404	
Seal/diaphragm material			
	E	EPDM/PTFE coated, only for PP and NP	
	B	FKM-B/PTFE coated, only for PP and NP	
	T	PTFE/PTFE coated, only for PV, TT and SS	
	S	Diaphragm with additional FKM coating for media containing silicate, FKM-B seals for PP and NP, PTFE for TT, PV and SS	
Liquid end version			
	0	Without bleed, without valve spring only for TT, SS and type 0232 NP, PP and PC	
	1	Without bleed, with valve spring only for TT, SS and type 0232 NP, PP and PC	
	2	With bleed, without valve spring only for PP, PVT, NP not for type 0232	
	3	With bleed, with valve spring only for PP, PVT, NP not for type 0232	
	4	Version for higher-viscosity media only for PVT, type 1005, 1605, 0708, 1008, 0413, 0713, 0220, 0420	
	9	Self-bleeding only for PP/NP, not for types 1000 and 0232	
Hydraulic connections			
	0	Standard connection according to technical data	
	5	Connector for 12/6 tube, discharge side only	
	9	Connector for 10/4 tube, discharge side only	
Version			
	0	With ProMinent® logo	
Power supply			
	A	200 – 230 V ± 10%, 50/60 Hz	
	B	100 – 115 V ± 10%, 50/60 Hz	
	U	100-230 V ± 10%, 50/60 Hz	
	M	12 – 24 V DC ± 10%, only type 1000-0220 \only with 2 m connecting cable open end	
	N	24 V DC ± 10%, only type 1605-0232 \only with 2 m connecting cable open end	
	P	24 V AC ± 10% all types	
Cable and plug			
	A	2 m Europe	
	B	2 m Swiss	
	C	2 m Australia	
	D	2 m USA	
	1	2 m open end	
Relay			
	0	No relay	
	1	Fault indicating relay NC, (change-over relay)	
	3	Fault indicating relay NO, (change-over relay)	
	4	As 1 + pacing relay, (each 1xON)	
	5	As 3 + pacing relay, (each 1xON)	
Accessories			
	0	No accessories	
	1	With foot and injection valve, 2 m PVC suction line, 5 m PE metering line	
Control type			
	0	No lock	
	1	With lock: manual operation blocked when external cable plugged in	
Control Variants			
	D	With CANopen interface for DULCOMARIN® II	
Options on request			
	0 0	No option	



2.4 Multi-Channel Multi-Parameter Measuring and Control System DULCOMARIN® II

2.4.20 Multi-Channel Measuring and Control System DULCOMARIN® II, Module Combinations

Number and type of modules required for a given number of pools

Number of filtration circuits	Central unit DXCa	P module	M module	A module*	Additional N or P module (power supply unit)	Free chlorine sensor	Total chlorine sensor (optional)
1	1	1	1	1	-	1	1
2	1	1	2	2	-	2	2
3	1	1	3	3	1	3	3
4	1	1	4	4	2	4	4
5	1	1	5	5	2	5	5
6	1	1	6	6	3	6	6
7	1	1	7	7	3	7	7
8	1	1	8	8	4	8	8
9	1	1	9	9	4	9	9
10	1	1	10	10	5	10	10
11	1	1	11	11	5	11	11
12	1	1	12	12	6	12	12
13	1	1	13	13	6	13	13
14	1	1	14	14	7	14	14
15	1	1	15	15	7	15	15
16	1	1	16	16	8	16	16

* No A module if metering pumps with CANopen are used.
 The above modules include all CAN bus connecting elements (T-distributor and spur line).
 The T-distributors can also be directly coupled.
 For distributed systems, the CAN cable must be ordered by the metre with the by-the-metre connecting kit.

	Order no.
CAN bulk cable connection kit*	1026589
Connecting cable - CAN, sold by the metre*	1022160

* The CAN by-the-metre connecting kit consists of a CAN coupling M12 5P and a CAN connector M12 5P and a wiring diagram.
 The by-the-metre connecting cable can be configured into a cable of individual length using the CAN by-the-metre connecting kit.
 One CAN by-the-metre connecting kit is required for each cable to be configured.
 The connecting cables CAN M12 5P 0.5 m (pump 1 m) supplied with the sensors and modules should be used for the spur lines.

If you have any questions, please contact our sales department.

Caution:

The maximum main bus length (not including stubs) should be at most 400 m.



2.4 Multi-Channel Multi-Parameter Measuring and Control System DULCOMARIN® II

2.4.21 Configuration Example 1

- A Pool attendant's room
- B Engineering room pool 1
- C Engineering room pool 2

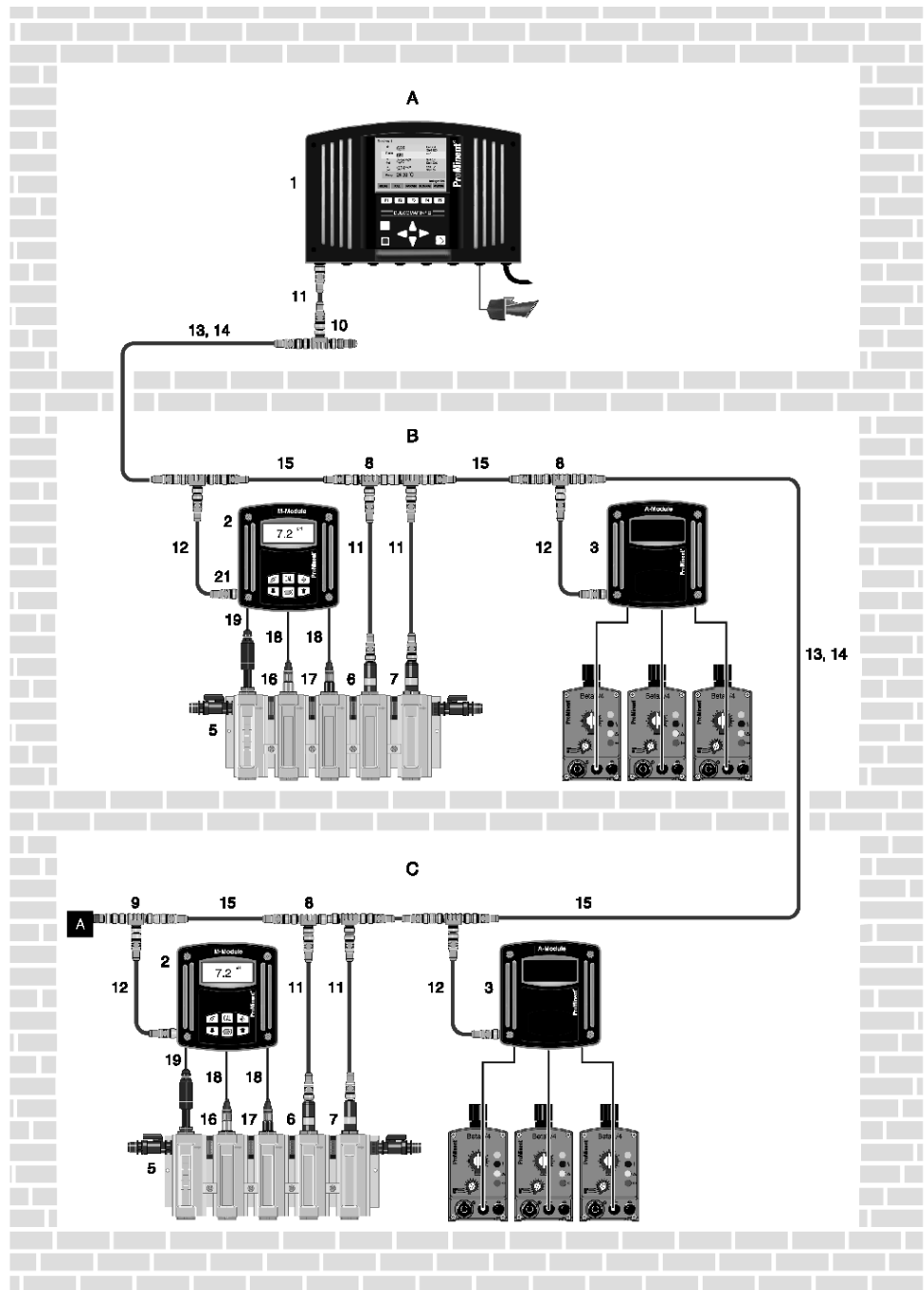

pk_5_022_1

Attention:

It is very important that you adhere precisely to the principle of the design shown above because otherwise correct function is not guaranteed!



2.4 Multi-Channel Multi-Parameter Measuring and Control System DULCOMARIN® II

Measuring and control system for two potable water systems/filtration circuits consisting of the following components:

Item	Quantity	Name	Order no.
1	1	DULCOMARIN® II central unit DXCa W 0 0 1 0 0 P S EN 01	-
2	2	M module DXMa M W 0 S EN 01	-
3	2	A module DXMa A W 2 0 00 01	-
5	2	DULCOTEST® in-line probe housing DGMa 3 2 2 T 0 0 0	-
6	2	Chlorine sensor CTE 1-CAN-10 ppm	1023427
7	2	Chlorine sensor CLE 3.1-CAN-10 ppm	1023426
8	9	T-distributor M12 5-pole CAN	Included in delivery
9	1	Termination resistance M12 coupling	Included in delivery
10	1	Termination resistance M12 plug	Included in delivery
11	5	Connection cable - CAN M12 5-way 0.5 m	Included in delivery
12	5	Connection cable - CAN M12 5-way 0.3 m	Included in delivery
13	-	Connecting cable - CAN, sold by the metre	1022160
14	-	CAN bulk cable connection kit	1026589
15	-	CAN M12 5-pole connection cable - length as required	-
16	2	pH sensor PHES 112 SE	150702
17	2	ORP sensor RHES-Pt-SE	150703
18	4	Cable combination coaxial Ø 5 mm 2 m - SN6 - pre-assembled	1024106
19	4 m	Two-wire measuring line 2 x 0.25 mm ² Ø 4 mm	725122

* The CAN by-the-metre connecting kit consists of a CAN coupling M12 5P and a CAN connector M12 5P and a wiring diagram.

The by-the-metre connecting cable can be configured into a cable of individual length using the CAN by-the-metre connecting kit.

One CAN by-the-metre connecting kit is required for each cable to be configured.

The connecting cables CAN M12 5P 0.5 m (pump 1 m) supplied with the sensors and modules should be used for the spur lines.

Caution:

The maximum main bus length (not including spur lines) should be at most 400 m.



2.4 Multi-Channel Multi-Parameter Measuring and Control System DULCOMARIN® II

2.4.22

Configuration Example: 2-Pool System

Two M modules in a central unit, use of metering pumps with CANopen bus.

- A Engineering room
- B Pool 1
- C Pool 2

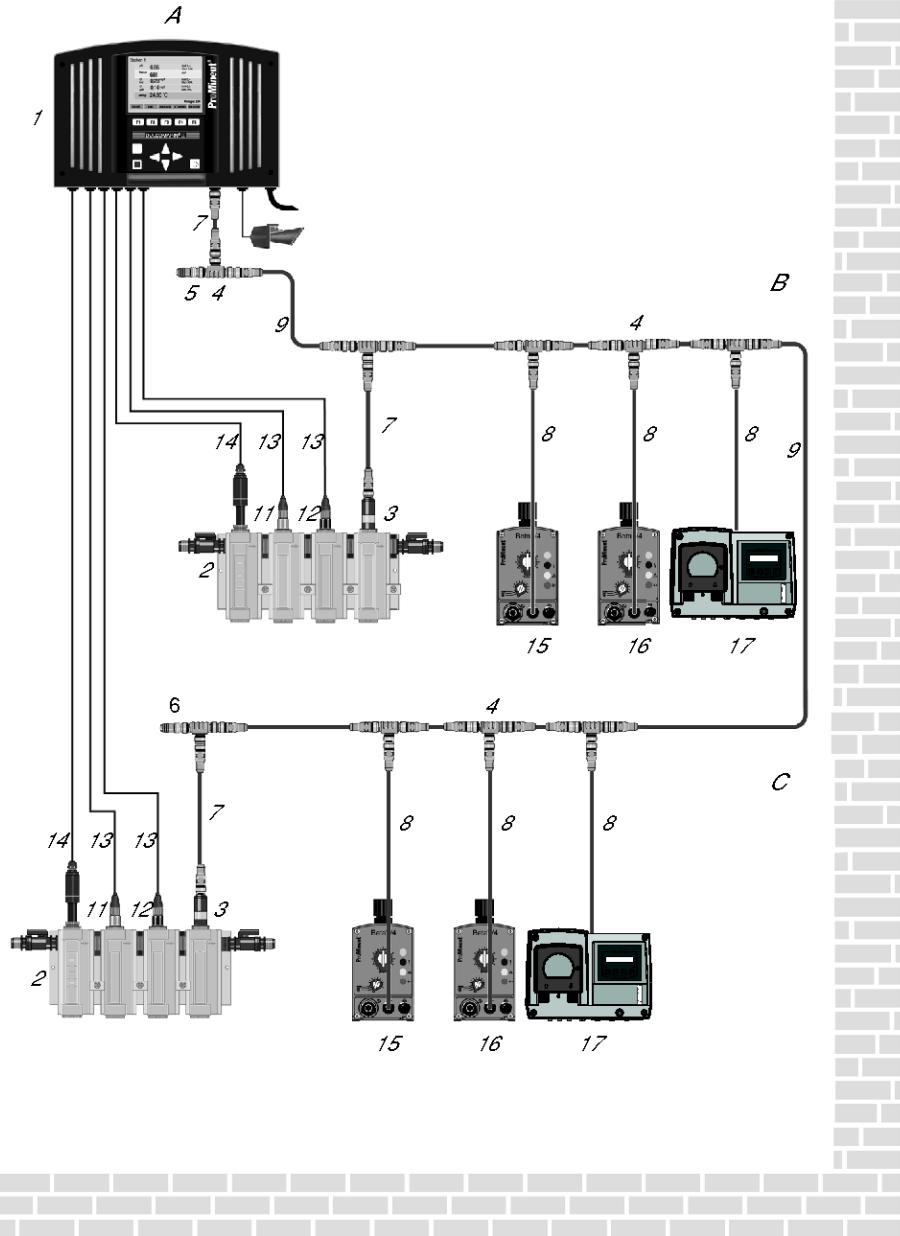

pk_5_022_neu

Attention:

It is very important that you adhere precisely to the principle of the design shown above because otherwise correct function is not guaranteed!





2.4 Multi-Channel Multi-Parameter Measuring and Control System DULCOMARIN® II

Measuring and control system for two filter circuits consisting of the following components:

Item	Quantity	Name	Order no.
1	1	DULCOMARIN®II central unit DXCa W 0 0 1 M M P S EN 01	–
2	2	DULCOTEST® in-line probe housing DGMa 3 2 2 T 0 0 0	–
3	2	Chlorine sensor CLE 3-CAN-10 ppm	1023425
4	9	T-distributor M12 5 pole CAN	Included in delivery
5	1	Termination resistor M12 connector	Included in delivery
6	1	Termination resistor M12 plug	Included in delivery
7	5	Connection cable - CAN M12 5-pole 0.5 m	Included in delivery
8	6	Connection cable - CAN M12 5-pole 0.3 m	Included in delivery
9	–	Connecting cable - CAN M12 5-pin. 10 m*	1046383
11	2	pH sensor PHES 112 SE	150702
12	2	ORP sensor RHES-Pt-SE	150703
13	4	Cable combination coaxial Ø 5 mm 2 m - SN6 - pre-assembled	1024106
14	4 m	Two-wire measuring line 2 x 0.25 mm ² Ø 4 mm	725122
15	2	Beta®/ 4 CANopen for pH correction BT4A0402PVT290UA000D00**	–
16	2	Beta®/ 4 CANopen for disinfectant BT4A0402PVT290UA000D00**	–
17	2	DF4a CAN for flocculant DF4aFW004015P9UA00001D10	–

* Up to 3 can be coupled from the connecting cable CAN M 12 5-pin 10 m.

** Suggested configuration

Caution:

Do not allow the maximum main bus length (without branch cables) to exceed 400 m.

2.4 Multi-Channel Multi-Parameter Measuring and Control System DULCOMARIN® II

2.4.23

Accessories for the DULCOMARIN® II Measuring and Control System

	Order no.
CLE 3-CAN-10 ppm	1023425
CLE 3.1-CAN-10 ppm	1023426
CTE 1-CAN-10 ppm	1023427
BRE 3-CAN-10 ppm	1029660
T-distributor M12 5 pole CAN	1022155
Termination resistor M12 coupling	1022154
Termination resistor M12 plug	1022592
Connecting cable - CAN M12 5 pole 0.3 m	1024568
Connecting cable - CAN M12 5-pole 0.5 m	1022137
Connecting cable - CAN M12 5-pole 1 m	1022139
Connecting cable - CAN M12 5-pole 2 m	1022140
Connecting cable - CAN M12 5-pole 5 m	1022141
Connecting cable - CAN M12 5-pin. 10 m*	1046383
Connecting cable - CAN M12 5-pole 25 m	1055588
Connecting cable - CAN M12 5-pole 50 m	1055589
Connecting cable - CAN, sold by the metre	1022160
CAN bulk cable connection kit	1026589
PHES 112 SE	150702
RHES-Pt-SE	150703
Cable combination coaxial Ø 5 mm 0.8 m - SN6 - pre-assembled	1024105
Cable combination Coaxial Ø 5 mm 2 m - SN6 - pre-assembled	1024106
Cable combination coaxial Ø 5 mm 5 m - SN6 - pre-assembled	1024107
Two-wire measuring line 2 x 0.25 mm ² Ø 4 mm	725122
Connecting cable LAN M12 - RJ45 5.0 m	1026715
Cross-over patch cable 2x RJ45 connector 5 m	1027859
LAN coupling 2x RJ45 socket 1:1	1027860
USB 2.0 SD card reader	732981
SD memory card/DXC measuring data archiving	1027470
Isolating amplifier 4-channel for mA outputs of the A module	1033536

* Up to 3 cables, each 10 m, can be coupled

The CAN bulk cable connection kit comprises a 5-pin M12 CAN coupling and a 5-pin M12 CAN plug and a wiring diagram.

The CAN bulk cable connection kit can be used to configure the connecting cable to form a cable of any required length.

One CAN bulk cable connection kit is required for each cable to be assembled.

The 0.5 m (1 m pump) 5-pin M 12 CAN connecting cables supplied with the sensors and modules have to be used as branch cables.

Caution:

Do not allow the maximum main bus length (excluding branch cables) to exceed 400 m!



2.4 Multi-Channel Multi-Parameter Measuring and Control System DULCOMARIN® II

PROFIBUS®-DP V1 Gateway

The CANopen – PROFIBUS®-DP V1 gateway is an interface based on CANopen, which connects the DULCOMARIN® II swimming pool controller or disinfection controller to a PROFIBUS® DP network. Here the DULCOMARIN® II is configured as the slave and the PLC is the master. Data traffic can be cyclic or acyclic. The measured values are transmitted cyclically. Setpoints can be changed, the system can be set to pause control and Eco!Mode operation can be activated in acyclic traffic. The corresponding GSD file can be downloaded from the ProMinent website and is also contained on the enclosed data medium.

The module is intended for installation in a control cabinet (top hat rail) and is connected to the CAN bus in the same way as other modules. The controller DULCOMARIN® II must have software version 3022 or higher. No specific identity code is needed.

Note: A separate 24 V DC voltage supply is required.

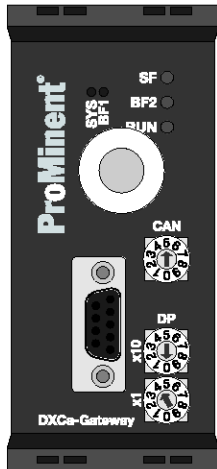

P_MSRZ_0014_SW

Voltage supply	24 V DC
Typical power consumption approx.	500 mA
Max. number of measured values	116
Weight	250 g
Dimensions L x W x H (mm)	117.2 x 45 x 113.5 mm
RoHS (Restriction of Hazardous Substances)	Yes
CE conformity	Yes
Enclosure rating	IP 20

Order no.

CANopen - PROFIBUS®-DP V1 gateway complete

1044462

Modbus RTU Gateway

The CANopen - Modbus RTU gateway is an interface based on CANopen, which connects the DULCOMARIN® II swimming pool controller or disinfection controller to a Modbus RTU network. Here the DULCOMARIN® II is configured as the slave and the PLC is the master. Data traffic can be cyclic or acyclic. The measured values are transmitted cyclically. Setpoints can be changed, the system can be set to pause control and Eco!Mode operation can be activated in acyclic traffic. The corresponding description table can be found in the operating instructions. These be downloaded from the ProMinent website and are also contained on the enclosed data medium.

The module is intended for installation in a control cabinet (top hat rail) and is connected to the CAN bus in the same way as other modules. No specific identity code is needed.

Note: A separate 24 V DC voltage supply is required.

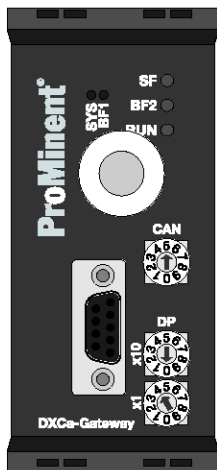

P_MSRZ_0014_SW

Voltage supply	24 V DC
Typical power consumption approx.	500 mA
Max. number of measured values	116
Weight	250 g
Dimensions L x W x H (mm)	117.2 x 45 x 113.5 mm
RoHS (Restriction of Hazardous Substances)	Yes
CE conformity	Yes
Enclosure rating	IP 20

Order no.

Gateway CANopen - Modbus RTU

1047247



2.4 Multi-Channel Multi-Parameter Measuring and Control System DULCOMARIN® II

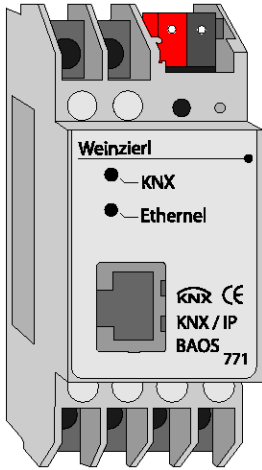

P_MSRZ_0017_SW1

Ethernet KNX Gateway

The Ethernet – KNX gateway is an Ethernet-based interface that connects the DULCOMARIN® II swimming pool controller or disinfection controller to a KNX building control system. The measured values and status messages from one system can be transmitted. No feedback effect from the KNX network is possible.

The module is intended for installation in a control cabinet (top hat rail) and is connected to the LAN/ Ethernet connector of the DXCa. The DXCa needs to have communication option 5 = web server or 8 = web server + OPC server for this.

Note: A separate 24 V DC power supply is required.

Voltage supply	12 – 24 V DC
Typical power consumption approx.	500 mA
Max. number of measured values (max. 2-pool system)	20
Weight	100 g
Dimensions L x W x H (mm)	117.2 x 60 x 113.5 mm
RoHS (Restriction of Hazardous Substances)	Yes
CE conformity	Yes
Enclosure rating	IP 20

Order no.

Gateway Ethernet-KNX

1047326

ER75i Mobile Phone Router (GSM/GPRS/EDGE)



P_MSRZ_0018_SW1

You can connect to your disinfection controller DULCOMARIN® II using the mobile communications router ER75i irrespective of distance. Mobile Ethernet makes it possible to use the available infrastructure for location-independent Ethernet communication. In addition to GSM and GPRS, EDGE technology can also be used for data transfer. Stable and permanent connections are monitored and maintained through continuous control. An integrated DHCP server makes possible simple installation and fast Internet access. The ideal device for alarm signalling, remote maintenance and remote service.

Note: The mobile communications router ER75i is specially configured for the disinfection controller DULCOMARIN® II. The controller must have at least communication interface option 5, "Embedded web server". The mobile communications router is not included in this DXCa option.

Important for operation of the mobile communications router:

- The products do not include a mobile communications data contract, which has to be concluded separately with a mobile communications provider.
- Please check in advance the network coverage of your mobile communications provider.
- Make sure that the installation can be installed in a place whether the received signal has sufficient strength and there is also a power supply.

Scope of delivery: Router, CD, patch cable, magnetic foot aerial, plug-in power pack

GPRS/EDGE (class 10) mobile phone router for industrial applications (max. download 236 Kbit/s, max. upload 118.4 Kbit/s)

Single web-interface, DHCP, DynDNS, VRRP, NTP, dial-in router control via SMS

Data volume / roaming control via SMS

Status Information via SNMP and SMS

LED status display

Frequency bands: 850/900/1800/1900 MHz

Interfaces: Ethernet 10/100

External GSM aerial: FME - 50 Ω

Power supply: 10 ... 30 V DC

Working temperature range: -30 °C ... +60 °C

Dimensions: 30 x 90 x 102 mm, plastic housing, also for wall mounting

Weight: 190 g (without aerial and plug-in power pack)

Degree of protection: IP 44, for use in dry rooms or offices

Order no.

GSM/GPRS/EDGE mobile phone router ER75i

1047329

2.4 Multi-Channel Multi-Parameter Measuring and Control System DULCOMARIN® II



P_MSRZ_0019_SW1

UR5i Mobile Phone Router (UMTS/HSPA+)

You can connect to your disinfection controller DULCOMARIN® II using the mobile communications router UR5i via UMTS/HSPA+ irrespective of the distance. Mobile Ethernet makes it possible to use the available infrastructure for location-independent Ethernet communication. UMTS/HSPA+ technology can be used for data transfer. Stable and permanent connections are monitored and maintained through continuous control. An integrated DHCP server makes possible simple installation and fast Internet access. The ideal device for alarm signalling, remote maintenance and remote service. With WLAN access. The WLAN access has no bridge function for connection of another WLAN network.

Note: The mobile communications router is specially configured for the disinfection controller DULCOMARIN® II. The controller must have at least option 4, "Alarm signalling via SMS / email", or higher. The mobile communications router is not included in this DXCa option.

Important for operation of the mobile communications router:

- The products do not include a mobile communications data contract, which has to be concluded separately with a mobile communications provider.
- Please check in advance the network coverage of your mobile communications provider.
- Make sure that the installation can be installed in a place whether the received signal has sufficient strength and there is also a power supply.

Scope of delivery: Router, CD, patch cable, magnetic foot aerial, plug-in power pack. Degree of protection: IP 44, for use in dry rooms or offices.

UMTS/HSPA+ Tri-Band (max. download 14.4 Mbit/s, max. upload 5.7 Mbit/s)

WLAN supported NAT/PAT and X.509

Integrated firewall (SPI)

Single web-interface, DHCP, DynDNS, VRRP, dial-in router control via SMS

Data volume / roaming control via SMS

Status information via SNMP and SMS

Extensive mobile connection statistics options

LED status display

Frequency bands: GSM/GPRS/EDGE: 850/900/1800/1900 MHz
UMTS: 850/900/1900/2100 MHz

External GSM aerial: SMA - 50 Ω

Power supply: 10 ... 30 V DC

Working temperature range: -30 °C ... +60 °C

Dimensions: 50 x 84 x 117 mm, DIN top hat rail 35 mm

Weight: 207 g

Degree of protection: IP 44

Order no.

UMTS/HSPA+ mobile phone router UR5i v2F

1047330



2.5 DULCOMARIN® 3 multi-channel multi-parameter measuring and control system for water treatment

2.5.1 Measuring and control system DULCOMARIN® 3

The DULCOMARIN® 3 will be available from April 2018. The DULCOMARIN® II will continue to be supplied up to this date.

New features and functions – a major step for the DULCOMARIN®. A gigantic step for your pool system.

The measuring and control system DULCOMARIN® 3 is your digital link to the technology of the future. It controls the entire range of swimming pools – from adventure pools to private pools. The system is operated using the large 7" touch display.

The measuring and control system DULCOMARIN® 3 is a reliable system for the treatment of swimming pool water. The new interactive start-up wizard uses questions about system planning to guide you through planning of your complete system. You can transfer the planning outcome and all components into the commissioning menu using drag & drop. This enables quick and easy commissioning of your measuring and control system DULCOMARIN® 3.

The intuitive menu guidance is also supported by videos, and shows step-by-step calibration of the sensors.

It is operated using the system's touch display. You can also operate the DULCOMARIN® 3 remotely via the Internet. So you can connect to your DULCOMARIN® 3 using your smartphone or any other Internet-compatible end device. You can therefore also control other features, lighting, circulating pumps and filter backwash. The system can be extended at any time to meet future requirements.

The circulation capacity of the pumps adapts to the water quality in Eco! operating mode. Chemicals are metered precisely according to demand based on measured values, reducing ongoing energy costs and saving chemicals.

The DULCOMARIN® 3 is the central element of the measuring and control system. All the information relating to the individual pools and associated control circuits is collated here. Every other pool is linked to a DULCOMARIN® 3 module, independently of the distance of the pools. You can calibrate the sensors on site here and also set the parameters.

The DULCOMARIN® 3 is connected to a building management system via OPC and KNX. PROFIBUS® DP and Modbus RTU are available for connection to a PLC Programmable Logic Controller. Every DULCOMARIN® 3 module can be equipped with Wi-Fi for operation by tablet or smartphone.

Your benefits

- Energy- and cost-efficient control of your swimming pool
- The DULCOMARIN® 3 can be accessed from every internet-compatible device
- Simple calibration of the sensors with video support
- Fast product selection and configuration of your system via web browser
- Status messages and alarm by e-mail
- View and assess the time-based course of the measured values of all pools on the built-in screen writer
- Simple, unrestricted LAN connection – like in your home network
- Subsequent extendibility due to the LAN-based bus system
- Intelligent chlorine sensors: save the sensor data and are always in the optimum measuring range with auto-ranging
- Intelligent metering pumps: provide information on operating parameters, such as chemical level statuses and pump capacity, within the range of 0.7 l/h to 1,000 l/h
- Coupling to a PLC Programmable Logic Controller via PROFIBUS® DP and Modbus RTU
- View historical measured data directly on the controller: enabled by the integral screen writer with data logger via USB

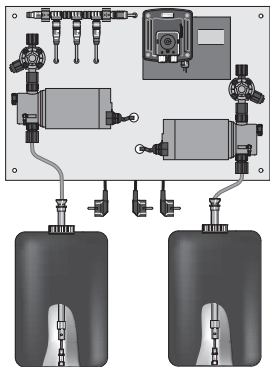
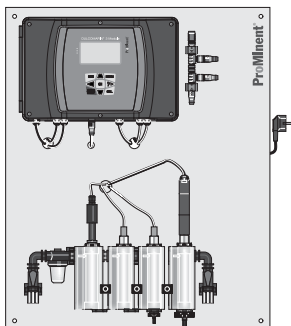

P_DD_0049_SW



2.5 DULCOMARIN® 3 multi-channel multi-parameter measuring and control system for water treatment

NEW

Technical Details

- Measured variables: pH, ORP, free chlorine, total chlorine, combined chlorine, bromine, chlorine dioxide, ozone and temperature
- Precision: 0.5% of the measuring range limit value
- Control characteristic: P/PI/PID control
- Digital inputs: 8 potential-free control inputs e.g. for measured water errors, pause, control, parameter switch-over
- Modular ports: 4 to accommodate 2-channel I/O modules in each, selectable via identity code and retrofittable
- Pump relay (pulse frequency): 4
- Output relay: 3 potential-free changeover contacts, 3 changeover contacts supplied
- Signal current output: via 2-channel I/O modules 2 x 0/4-20 mA or 4 x 0/4-20 mA
- Interfaces: USB, LAN (Ethernet), Wi-Fi (WLAN)
- Supply voltage: 100 – 230 V ± 10 %, 50/60 Hz, optionally 24 V DC

Field of application

- Control and regulation of the entire range of swimming pools
- Water parks
- Public swimming pools
- High-end private pools

The applications are defined in the identity code

Every potable water system or every filtration circuit has a proprietary on-site calibration option for all measured variables.

What is the Eco!Mode operating mode?

Eco!Mode permits the circulation capacity to be lowered when the DIN hygiene parameters pH, ORP, free and combined chlorine are within the permitted limits.

A circulating pump with frequency converter with analogue input is needed for this.

The reduction can be activated via a remote control, dependent on the DIN hygiene parameters being observed, the time and appropriate activation. A combination of criteria is also possible. If the DIN hygiene parameters are no longer adhered to, then the circulation capacity is again raised to the nominal power.

Lowering pump capacity saves energy and, in so doing, reduces CO₂ emissions.

In addition, upon reaching an adjustable ORP potential, e.g. 780 mV, which signals effective disinfection of the water, chlorine metering is reduced either gradually or in one step. If the DIN hygiene parameters are no longer adhered to, then chlorine metering is again increased to the normal setpoint.

What is a web server?

A web server is a software application executed by the DULCOMARIN® 3.

The web server delivers web pages with information about measurements, control, sensor calibration and control configuration to a PC with a web browser (e.g. Microsoft® Internet Explorer).

The web server enables simple and straightforward visualisation of the DULCOMARIN® 3, without special visualisation software being required on the PC. The web server is independent of the PC's operating system.

The DULCOMARIN® 3 is connected to a PC via a LAN/Ethernet interface. The connection can be made directly, via a network or via the internet. The cables needed for direct connection to a PC or network connection are included in the option.

Standard commercially available network components can be used as accessories for cables, routers and WLAN access points etc.

The same information can be accessed via the web server as is available on the DULCOMARIN® 3 itself, for instance changing setpoints for all control variables, switching off the different controllers and entering names for the pools/systems. The exceptions are the control settings and bus configuration that can only be entered directly on the controller.

What is OPC?

OPC stands for Openness, Productivity, Collaboration (formerly OLE for Process Control) and is used to describe a uniform software interface independent of specific manufacturers. OPC Data Access (OPC DA) is based on Windows COM (Component Object Model) and DCOM (Distributed Component Object Model) technology. OPC XML, in contrast, is based on the internet standards XML, SOAP and HTTP.

OPC is used wherever sensors, controllers and controls supplied by different manufacturers are used to create a common, flexible network. Without OPC, two devices would require precise knowledge about the communication options of the other device to be able to exchange data and extensions and exchanges would be correspondingly difficult. With OPC it is sufficient to write an OPC-compliant driver precisely once for each device and ideally this is provided by the manufacturer. An OPC driver can be integrated without



2.5 DULCOMARIN® 3 multi-channel multi-parameter measuring and control system for water treatment

extensive adaptation into any large control and monitoring systems.

ProMinent supplies an OPC server/driver, such as this, for the multi-channel measuring and control system DULCOMARIN® 3.

The examples shown in the following are suitable for applications in potable water treatment and in swimming pool technology.

Compliance of all units with CANopen specifications:

On the hardware side, all units comply with the harmonised CAN specification 2.0 (ISO99 – 1, ISO99 – 2). This includes the CAN protocol (ISO 11898 – 1) and details on the physical layer in compliance with ISO 11898 – 2 (high speed CAN up to 1 Mbit/sec) and ISO 11898 – 3 (low speed CAN up to 125 kBit/sec). The device complies with the CAN-Open specification CIA-DS401 that forms the basis of the European standard EN50325 – 4. It also complies with the controller device profile CiA-404.



2.5 DULCOMARIN® 3 multi-channel multi-parameter measuring and control system for water treatment

2.5.2 Measuring and control system DULCOMARIN® 3

Configuration example: 1-pool system

The specific example of a measuring and control system for pH, ORP, free chlorine and temperature for a filter circuit consists of the following components (without metering technology):

A Plant room

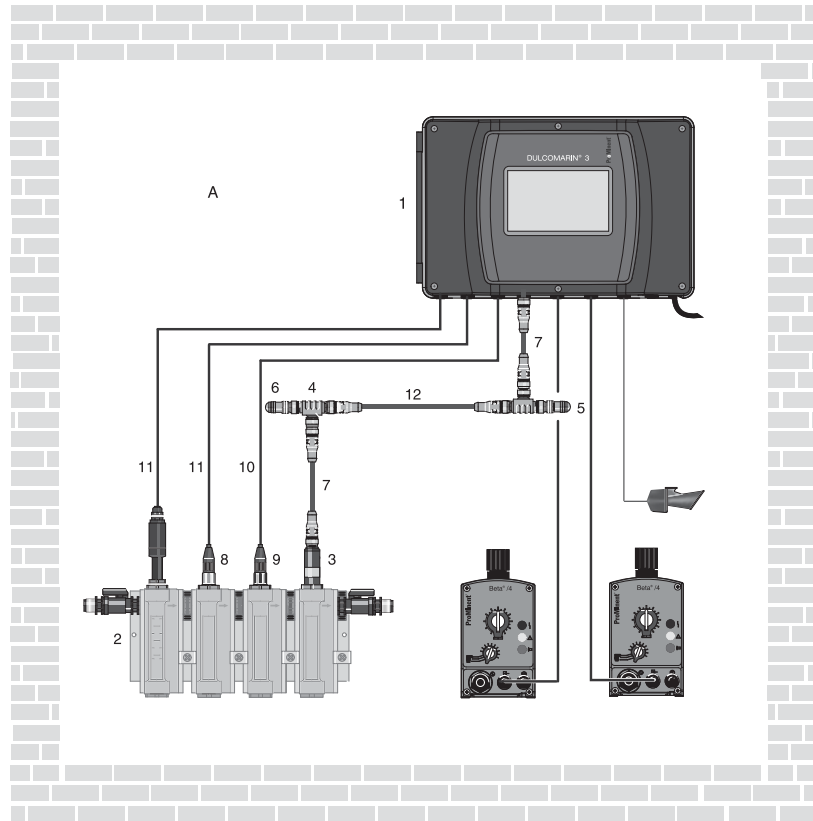

AP_DC_0013_SW

Item	Quantity	Name	Order no.
1	1	DULCOMARIN® II central unit with measuring and control modules DXCa W 0 0 1 M A P S EN 01	DCPAEUWPMA6L001 XXEN01
2	1	DULCOTEST® in-line probe housing DGMa 3 2 1 T 0 0 0	–
3	1	Chlorine sensor CLE 3-CAN-P-10 ppm	1083209
4	3	T-distributor M12 5 pol. CAN	Included in delivery
5	1	Termination resistance M12 connector	Included in delivery
6	1	Termination resistance M12 plug	Included in delivery
7	3	Connection cable - CAN M12 5 way 0.5 m	Included in delivery
8	1	pH sensor PHES 112 SE	150702
9	1	ORP sensor RHES-Pt-SE	150703
10	2	Cable combination, coaxial, Ø 5 mm 2 m - SN6 - pre-assembled	1024106
11	2 m	Two-wire measuring line 2 x 0.25 mm ² Ø 4 mm	725122
12	–	Connecting cable - CAN, sold by the metre	1022160



2.5 DULCOMARIN® 3 multi-channel multi-parameter measuring and control system for water treatment

Example 2

The specific example of a measuring and control system for pH, ORP, free and combined chlorine and temperature for a filter circuit consists of the following components (without metering technology):

A Plant room

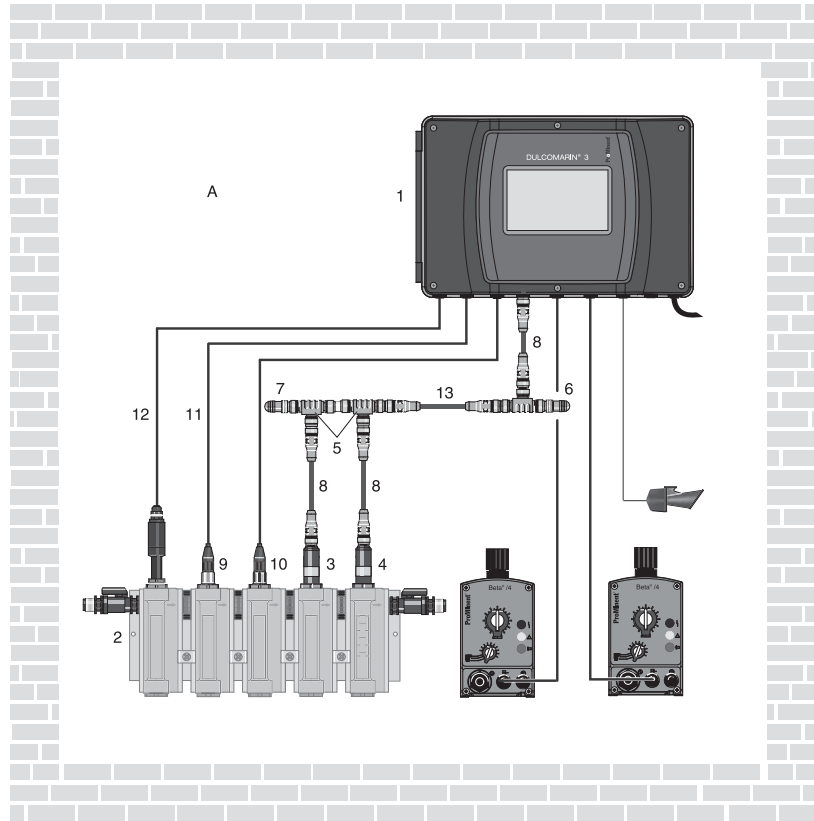

AP_DC_0012_SW

Item	Quantity	Name	Order no.
1	1	DULCOMARIN® II central unit with measurement and actuation modules DXCa W 0 0 1 M A P S EN 01	DCPAEUWPMA6L001 XXEN01
2	1	DULCOTEST® in-line probe housing DGMa 3 2 2 T 0 0 0	-
3	1	Chlorine sensor CTE 1-CAN-P-10 ppm	1083210
4	1	Chlorine sensor CBR 1-CAN-P-10ppm	1083135
5	3	T-distributors M12 5 pole CAN	Included in delivery
6	1	Load resistor M12-coupler	Included in delivery
7	1	Load resistor M12-plug	Included in delivery
8	3	Connecting cable - CAN M12 5 pole 0.5 m	Included in delivery
9	1	pH sensor PHES 112 SE	150702
10	1	ORP sensor RHES-Pt-SE	150703
11	2	Cable combination, coaxial, Ø 5 mm 2 m - SN6 - pre-assembled	1024106
12	2 m	Two-wire measuring line 2 x 0.25 mm ² Ø 4 mm	725122
13	1	CAN Connection cable	As required



2.5 DULCOMARIN® 3 multi-channel multi-parameter measuring and control system for water treatment

2.5.3 Identity code ordering system for DULCOMARIN® 3

DULCOMARIN® 3

DCPa	Regional design	
EU	Europe (Standard)	
	Mounting type	
W	Wall-mounting	
	Design	
PM	ProMinent	
	Function	
O	Without multimaster	
	Application	
A	DULCOMARIN® 3, swimming pool	
E	Disinfection Controller	
	Supply voltage	
4	24 V DC	
6	100... 230 V, 50-60 Hz	
	Communication	
X	none	
L	LAN with web interface (please order LAN cable separately)	
W	WLAN with web interface	
V	LAN and WLAN with web interface (please order LAN cable separately)	
	Module slot 1	
0	No module	
1	Module 2 x mV/temperature (inputs pH/ORP)	
2	Module 2 x mA inputs (inputs mA sensor)	
3	Module 1 x mV/temperature 1 x mA input (pH/ORP, mA sensor)	
4	Module 2 x mA outputs (measured value/control)	
5	Module 2 x conductivity/temperature (conductive)	
	Module slot 2	
0	No module	
1	Module 2 x mV/temperature (inputs pH/ORP)	
2	Module 2 x mA inputs (inputs mA sensor)	
3	Module 1 x mV/temperature 1 x mA input (pH/ORP, mA sensor)	
4	Module 2 x mA outputs (measured value/control)	
5	Module 2 x conductivity/temperature (conductive)	
	Module slot 3	
0	No module	
1	Module 2 x mV/temperature (inputs pH/ORP)	
2	Module 2 x mA inputs (inputs mA sensor)	
3	Module 1 x mV/temperature 1 x mA input (pH/ORP, mA sensor)	
4	Module 2 x mA outputs (measured value/control)	
5	Module 2 x conductivity/temperature (conductive)	
	Expansion level 4 / module slot 4	
0	No module	
1	Module 2 x mV/temperature (inputs pH/ORP)	
2	Module 2 x mA inputs (inputs mA sensor)	
3	Module 1 x mV/temperature 1 x mA input (pH/ORP, mA sensor)	
4	Module 2 x mA outputs (measured value/control)	
5	Module 2 x conductivity/temperature (conductive)	
	Software packages	
XX	None	
01	P1 standard with web, VNC, SMS, email, data logger, etc.	
02	P1 + OPC	
04	P1 + KNX	
06	P1 + OPC + KNX	
	Smart Control	
XX	None	
01	ProMinent Cloud	
02	Diagnosis assistant	
03	Adaptive control	
04	Metering monitoring (weather-dependent)	
05	Cloud + diagnosis + adaptive control + metering monitoring	
	Operating Instructions	
XX	None	
DE	German	
EN	English	
FR	French	
ES	Spanish	
IT	Italian	
BG	Bulgarian	
CN	Chinese	
CZ	Czech	
DK	Danish	
EE	Estonian	
FI	Finnish	
GR	Greek	
HU	Hungarian	
IE	Irish	
JP	Japanese	
KR	Korean	
LT	Lithuanian	
LV	Latvian	
MT	Maltese	
NL	Dutch	
PL	Polish	
PT	Portuguese	
RO	Romanian	
SE	Swedish	
SK	Slovakian	
SL	Slovenian	
RU	Russian	
TH	Thai	
TR	Turkish	
ZZ	Flemish	
	Approvals	
01	-	



2.5 DULCOMARIN® 3 multi-channel multi-parameter measuring and control system for water treatment

2.5.4 Chlorine sensors for DULCOMARIN® II and 3

The technical data for the sensors can be found in the chapters indicated.

Sensor type	Measured variable	Determining combined chlorine	Compatible with contamination	Compatible with chlorine electrolysis	Chapter
CLE 3-CAN-P-10 ppm (order no.: 1083209)	Free chlorine	No	Limited suitability	Yes	1.3.3
CBR 1-CAN-P-10 ppm (order no.: 1083135)	Free chlorine	Yes, with CTE 1-CAN-P-10 ppm, order no. 1083210	Suitable for higher loads, surfactants	No	1.3.3
CLO 1-CAN-P-10 ppm (order no.: 1083134)	Free chlorine	No	Tolerant against biofilm formation with hydrodynamic cleaning	Yes	1.3.3
CTE 1-CAN-P-10 ppm (order no.: 1083210)	Total chlorine	Yes, with CBR 1-CAN-P-10 ppm, order no. 1083135	Suitable for higher loads, surfactants	No	1.3.5
CGE 3-CAN-P-10 ppm (order no. 1083211)	Total available chlorine	No	Suitable for higher loads, surfactants	Yes	1.3.4



2.6 Controller AEGIS II

2.6.1 Controller AEGIS II



Treatment of cooling water in evaporation cooling systems - VDI 2047-compliant

Controller AEGIS II continuously measures and controls the conductivity and biocide concentration to keep pipework and heat exchangers clean.

The AEGIS II records all the necessary measuring parameters for cooling water treatment and controls the functions necessary for smooth operation:

- Measures the electrolytic conductivity – controls bleeding
- Biocide metering – time-dependent or as measurement and control, VDI 2047-compliant (e.g chlorine)
- Corrosion measurement – determines whether enough corrosion inhibitor is being metered
- pH measurement – measures and controls the pH value

Your benefits

- Biocide metering is timer-controlled
- The online measurement and control of the biocide concentration can be continuous if required
- Serial web interface for unit configuration and remote maintenance. WLAN/WiFi as an option
- Bleed lock: blocks bleeding after biocide metering has taken place
- Forced bleeding: performs bleeding before biocide metering
- Operating status displayed by 10 status LEDs

Technical Details

- 8 digital inputs for contact water meter, flow detector and control signals
- 10 status LEDs display the operating status
- 9 flexible relay outputs: for setpoint-dependent flow volume-proportional or time-based control of actuators
- Measured variables: conductivity, pH, ORP, chlorine, bromine, chlorine dioxide and more

Field of application

- Control of bleeding in evaporation cooling systems
- Volume-proportional control or regulation of the metering of corrosion inhibitors, de-foamers and dispersants
- Measurement and control of the inhibitor concentration through the use of a fluorescence sensor
- pH measurement and optional pH control
- Metering of up to 2 biocides based on time or measured values

Technical Data

Measuring range

Connection type mV:

pH: 0.00 ... 14.00
ORP voltage: - 1,500 ... + 1,500 mV

Connector type mA (amperometric measured variables, measuring ranges according to the sensors):

Chlorine
Chlorine dioxide
Bromine

Temperature:

via Pt 100/Pt 1000, measuring range 0 ... 150 °C

Resolution

pH: 0.01
ORP voltage: 1 mV
Temperature: 0.1 °C
Amperometric analysis (chlorine etc.): 0.001/0.01 ppm, 0.01 Vol.%, 0.1 Vol.%

Inputs and outputs

3 plug-in module positions: Plug-in modules for 2-channel modules:
mA outputs, pH/ORP inputs, mA inputs for amperometric sensors and serial sensor inputs
1 input for flow signal
5 output relays acting as changeover contacts, of which 3 are potential-free and 2 are AC/DC
4 pulse frequency outputs
2 serial sensor inputs for CFTS sensors
8 digital status inputs

Accuracy

0.3 % based on the full-scale reading

Measurement input

pH/ORP (input resistance > 0.5 x 10¹² Ω)



P_AE_0002_SW1



2.6 Controller AEGIS II

Temperature compensation	Pt 100/Pt 1000 for pH
Temperature correction range	0 ... 100 °C
Control characteristic	P/PID control
Electrical connection	90 – 253 V, 50/60 Hz, 25 VA, 24 V DC
Field bus connection	Modbus RTU, additional field buses via gateway
Ambient temperature	0 ... 50 °C (for use indoors or with a protective enclosure)
Enclosure rating	Wall-mounted: IP 65
Tests and approvals	CE, MET (corresponding to UL as per IEC 61010)
Housing material	PPE with flame-proof finish
Dimensions H x W x D	220 x 250 x 122 mm
Climate	Permissible relative humidity: 95 %, non-condensing DIN IEC 60068 – 2-30



2.6 Controller AEGIS II

2.6.2 Identity code ordering system for AEGIS II cooling tower control

AGIB		Regional code	
		US	USA
		EU	Europe
		Design	
		00	with ProMinent logo
		Operating voltage	
		6	100 – 240 V, 50/60 Hz
		Communication interface	
		LO	LAN
		LB	LAN+Bluetooth
		WO	LAN + WLAN
		BW	LAN + WLAN + Bluetooth
		L1	LAN without M12 LAN cable
		LC	LAN+Bluetooth without M12 LAN cable
		W1	LAN + WiFi without M12 LAN cable
		WC	LAN + WiFi + Bluetooth without M12 LAN cable
		Application pre-setting	
		T1	One cooling tower
		Serial sensor A	
		00	none
		CT	CTFS sensor for cooling tower
		Serial sensor B	
		00	none
		CT	CTFS sensor for cooling tower
		Extension slot 1 (Input C/D)	
		XX	none
		L3	Conductivity temperature sensor input
		AA	mA/mA sensor input
		H1	mA/mA output
		D1	serial sensor module
		Extension slot 2 (Input E/F)	
		XX	none
		L3	Conductivity temperature sensor input
		AA	mA/mA sensor input
		V2	mV/mV temperature sensor input
		H1	mA/mA output
		D1	serial sensor module
		V1	mV/temperature + mA module
		Extension slot 3 (Input I/J)	
		XX	none
		L3	Conductivity temperature sensor input
		AA	mA/mA sensor input
		V2	mV/mV temperature sensor input
		H1	mA/mA output
		D1	serial sensor module monitoring
		V1	mV/temperature + mA module
		Pump activation (P/V)	
		0	Relay with free adjustment
		P	Supplied (115/230 V), relay (R1+R2)
		V	Pulse frequency (P6 to P9)
		X	Combination of option P+V
		Pre-wired relay outputs	
		0	Only for use outside Europe
		Pre-wired output relay	
		0	Only for use outside Europe
		Inhibitor metering outputs	
		0	Relay with free adjustment
		1	one
		2	two
		Biocide metering outputs	
		0	Relay with free adjustment
		1	one
		2	two
		3	three
		Hardware extension	
		0	none
		Approvals	
		01	CE
		07	MET (USA)
		08	CE + MET (Europe)
		Documentation language	
DE		deutsch	
EN		English	
ES		Spanish	
FR		French	
BG		Bulgarian	
CS		Czech	
DA		Danish	
ET		Estonian	
EL		Greek	
FI		Finnish	
HR		Croatian	
HU		Hungarian	
IT		Italian	
JA		Japanese	
KO		Korean	
LT		Lithuanian	
LV		Latvian	
NL		Dutch	
PL		Polish	
PT		Portuguese	
RO		Romanian	
SK		Slovakian	
SR		Serbian	
SL		Slovenian	
SV		Swedish	
RU		Russian	
TH		Thai	
TR		Turkish	
ZH		Chinese	



2.6 Controller AEGIS II

Retrofit modules for controller AEGIS II for subsequent extension of functions

	Order no.
Module 2x mA output	734143
Module 2x MA input	734126
Module 2x mV/temp input	734131
Module 2x serial sensor	734265
Module 2x cond/temperature	734223
Module: mV/temp mA input	734355

DULCOTEST® sensor for conductivity, type CTFS

Multi-parameter sensor for electrolytic conductivity, temperature and flow control for use in cooling water treatment. Installation in bypass fitting DGMA and in DN 20 pipework. For operation on AEGIS® II cooling tower controller

Your benefits

- 3 measured variables in one sensor: electrolytic conductivity, temperature and flow control
- Auto-ranging within the measuring range for electrolytic conductivity 100...10,000 µS/cm



NEW

Measuring range	0.1...10 mS/cm
Cell constant k	10.00 cm ⁻¹ ±5%
Temperature measurement	Semiconductor temperature sensor
Medium temperature	0 ... 50 °C
Max. pressure	7.0 bar up to 35 °C, (at 25 °C)
Sensors	Graphite, epoxy
Shaft material	PP
Seals	FKM
Thread	see Installation
Fitting length	see Installation
Installation	Einbau ohne beiliegenden drehbaren Adapter: in DGMA, Modul 25 mm: Adapter CTFS/DGMA M25-NPT 3/4" PVDF, Best. Nr. 1080293., Einbau mit beiliegendem drehbaren Adapter in PVC-Leitungen: T-Stück, DN 20/d25, 3/4", Best. Nr. 356455.
Electrical connection	3 m fixed cable, extendible to 50 m, with cable type: 0.5 mm ² or AWG 22.
Enclosure rating	IP 65
Typical applications	Cooling water
Resistance to	Ingredients in the water of the target application, taking into account the compatibility of the material
Measuring and control equipment	AEGIS® II cooling tower controller
Measuring principle, technology	Conductive. Integrated temperature measurement and thermal flow detector

	Order no.
CTFS sensor conductivity/temperature/flow complete	1081727

Please observe the general notes on p. → 1-89 (Overview Table for Conductivity Sensors)

2.7 Controller with Integral Metering Pump

2.7.1 Controller with Integral Metering Pump

You can find the Solenoid-Driven Metering Pump delta® with controller module in Volume 1



pk_1_131_2
delta®



2.8 DULCOMETER® Transmitters

2.8.1

Transmitter DULCOMETER® DMTa

The compact 2-wire transmitter – the link to the PLC and DULCOMETER®.

The transmitter DULCOMETER® DMTa converts the sensor signals for pH, ORP value, chlorine concentration and conductivity into an interference-insensitive 4-20 mA analogue signal. Flexible, safe and always the optimum resolution of measured value.



The 2-wire transmitter DMTa converts the following sensor signals into an interference-insensitive 4-20 mA analogue signal: pH, ORP, temperature, chlorine and conductivity.

It is fed via the 2-wire analogue input of a PLC or via a 2-wire analogue input of a ProMinent controller. The 4-20 mA analogue current proportional to the measured value is transmitted via the same two lines.

The DMTa offers an on-site calibration option of the sensor and galvanic separation between the sensor input and measured value output.

Your benefits

- Flexibility in the choice of measured variable with pH, ORP and temperature
- Excellent operational safety, thanks to sensor monitoring (pH)
- Galvanic isolation between the sensor and supply
- Always the optimum measured value resolution by auto-ranging with conductivity measurement
- Safety through sensor monitoring of pH for glass breakage and line breakage
- Various installation options: wall-mounted, installation on an upright or in a control cabinet

Technical Details

- Measured variables: pH, ORP, chlorine, temperature and conductivity
- Accuracy: 0.5% of the upper range value
- Correction variable: Temperature via Pt 100/Pt 1000 (pH, chlorine, conductivity)
- Communication interface: PROFIBUS®-DP (wall-mounted only)
- Protection class: IP 65 (wall-mounted, pipe installation), IP 54 (installation in a control cabinet)
- Display: Graphic display

Field of application

Measuring technology in water treatment in the following sectors:

- Processes and process technology
- Food and beverage industry
- Chemical industry
- Pharmaceuticals
- Waste water treatment
- Power station technology

Technical Data

Measuring range	pH - 1.00 ... 15.00 - 1200 ... +1200 mV ORP voltage 0.01 ... 50.0 mg/l chlorine -20 ... +150 °C 1 µS/cm ... 200 mS/cm (autoranging), corresponding to cell constant
Cell constant	0.006 ... 12.0/cm for conductivity
Resolution	0.01 pH 1 mV 0.1% from measurement range for chlorine 0.1 °C Conductivity 1/1000 of display value (min. 0.001 µS/cm)
Accuracy	0.5% from measurement range
Measurement input	mV terminal (pH, ORP); input resistance > 5 x 10 ¹¹ Ω Chlorine terminal (DMT chlorine sensors) Pt 100/1000 terminal Conductivity terminal (2 or 4 wire connector)
Correction variable	Temperature via Pt 100/1000 (pH, chlorine, conductivity)
Correction range	Chlorine: 5 ... 45 °C, pH: 0 ... 100 °C, conductivity: 0 ... 100 °C
Current output	4...20 mA
Fault current	23 mA

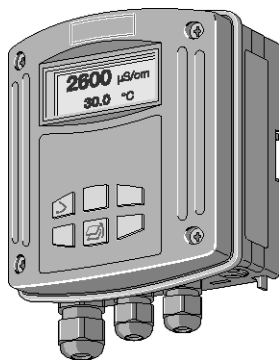

pk_5_001





2.8 DULCOMETER® Transmitters

Feed voltage	2-wire transmitter, 16 ... 35 V DC, nominal 24 V PROFIBUS®-DP version, 16 ... 30 V DC, nominal 24 V
Communication interface	PROFIBUS®-DP (wall-mounted version only)
Permissible ambient temperature	0...55 °C
Climate	Relative humidity up to 95% (non-condensing)
Enclosure rating	IP 65 (wall/pipe mounted) IP 54 (control panel installation)
Display	graphical display
Housing material	PPE
Dimensions H x W x D	135 x 125 x 75 mm
Weight	0.45 kg

A complete measuring station comprises the following:

- DMTa measuring transducer (see Identity code)
- In-line probe fitting: DGMa..., DLG III ..., immersible in-line probe fitting
- Chlorine sensor (dependent on Identity code)
- Assembly set for chlorine sensor
- pH sensor (dependent on Identity code)
- ORP sensor (dependent on Identity code)
- Temperature sensor Pt 100 /Pt 1000 (dependent on Identity code)
- Conductivity sensor
- Sensor cable
- PROFIBUS® DP connection accessories

(for further information: Immersion Fittings see page → 1-128; Sensors for Chlorine see page → 1-49; pH Sensors with SN6 or Vario Pin Plug-In Head see page → 1-10; ORP Sensors with Fixed Cable see page → 1-43; DULCOTEST® Temperature Sensors see page → 1-46; Conductivity Sensors see page → 1-88; Sensor Accessories see page → 1-119; Metering Monitor, Signal Cable see volume 1 page)

2.8 DULCOMETER® Transmitters

2.8.2 Identity Code Ordering System for Transmitter DMTa

DULCOMETER® Transmitters

DMT	Series	
	A	Version
		Installation
		W Wall mounted (also pillar mounted)
		S Control panel installation ¹
		Version
		0 With ProMinent® logo
		Power supply
		9 Current loop 4-20 mA (two wire technology), operating voltage 16...40 V DC, nominal 24 V DC (only if communication point = none)
		5 PROFIBUS® DP, operating voltage 16...30 V DC, nominal 24 V DC (only if communication interface = PROFIBUS® DP)
		Communication interfaces
		0 None
		4 PROFIBUS® DP (assembly type W only)
		Measured variable 1
		P pH
		R ORP
		T Temperature
		C Chlorine
		L Conductivity
		Measured variable 2 (Correction variable)
		1 Temperature Pt 1000/Pt 100
		0 None (in the case of measured variable T)
		Enclosure rating
		0 Standard
		Language
		D german
		E english
		F french
		S spanish
		I italian
		Presetting A, probe
		0 Standard ProMinent® buffer solution pH 7 and 4
		D Reference buffer DIN 19266 pH 7 and 4
		V Variable buffer recognition
		Presetting B, probe
		0 Autom. temperature measurement (standard)
		1 Manual temperature measurement
		2 Autom./manual temperature measurement
		9 No temperature measurement
		Presetting C, output
		0 Proportional measured variable (Standard)
		1 Manual adjustable current value
		2 Proportional or manual
		3 Proportional or manual hold
		4 4 mA constant current

The last four figures in the identity code represent the software defaults, e.g. cell constants for conductivity, temperature compensation, etc.

0 = standard parameters

The measuring transducer can be factory-set. The defaults can be easily changed in the operating menu.

Note:

¹ The rear housing part is omitted for control panel mounting.



2.8 DULCOMETER® Transmitters

2.8.3 Application Example: Measurement of Free Chlorine with Connection to a PLC

Tasks and applications

In the treatment of drinking water in a water works with a PLC as the higher-order control system, simple measuring stations are needed to measure the disinfectant "free chlorine" at the outlet of the water works and thereafter to monitor protection of the network in the distribution system. Metering is proportional to the flow and is controlled by the PLC. The following conditions must be met:

- Disinfectant: free chlorine with an adjustable concentration of 0.1 ppm
- Raw water: groundwater with a pH of 7.5 and a temperature of 8-13 °C
- Installation of the measuring station in the bypass of the process flow
- Display of the measurement result and calibration by a measuring instrument in the proximity of the bypass installation and transmission of the measured value to the PLC via an electrically isolated 4-20 mA signal
- Power supply to the measuring instrument via the PLC (two wire instrument)

Components of the measuring/control station

Quantity	Name	See page	Order no.
1	Transmitter DMTa	→ 2-86	DMTa W090C00D000
1	Sensor for free chlorine CLE 3-DMT-5 ppm	→ 1-53	1005511
1	Universal cable, 5-pin round plug	→ 1-120	1001300
1	Bypass fitting DGMA	→ 1-126	DGMA 101T000

Benefits

- Simple, compact and cost-effective measuring station close to the bypass installation
- Electrical installation cost-savings due to power supply over a two wire system
- No need for electrical isolation of the output signal by electrical isolation integral to the DMT



2.8 DULCOMETER® Transmitters

2.8.4 Transmitter DULCOMETER® DULCOPAC



The compact transmitter for installation in control cabinets.

The transmitter DULCOMETER® DULCOPAC is a complete PID controller for the key measuring parameters in water treatment. It can be installed on a top hat rail inside a control cabinet.

The DULCOPAC transmitter in a DIN housing is intended for installation on a top hat rail (in a control cabinet). It measures and regulates the measured variables in aqueous solutions: pH, ORP, chlorine and conductivity.

With the measured variables pH and ORP, it is possible to select between a DULCOPAC transmitter with a highly-ohmic coaxial input (direct connection of a pH/ORP sensor) or a 4-20 mA two-wire input. A transmitter is also needed when connecting pH or ORP via 4-20 mA (part no. 809126 for pH and part no. 809127 for ORP).

Two analogue outputs (0/4...20 mA) are available for recording purposes and two potential-free low voltage relays with a changeover contact for control of metering pumps. The analogue outputs are galvanically isolated. The DULCOPAC is operated and configured using buttons and the integrated LC display via codes.

The power supply is provided via a special DULCOPAC power supply and can feed up to 10 DULCOPAC units. It provides the requisite galvanic isolation to the mains power supply.

Your benefits

- Space-saving: Direct installation in a control cabinet
- Safe measuring technology: galvanic isolation between the sensor and power supply

Technical Details

- Measured variables: pH, ORP, chlorine, conductivity and temperature
- Correction variable: Temperature for pH and conductivity via Pt 100
- Control action: P/PID control
- Control: Bidirectional control
- Signal current output: 2 x 0/4-20 mA galvanically isolated
- Degree of protection: IP 20

Field of application

- Measurement and control of water parameters in industrial and process water treatment plants
- Processes and process technology
- Electroplating
- Waste water treatment

Technical Data

Measuring range

pH: 2.00 ... 14
 ORP: -1,500 ... +1,500 mV
 Chlorine: 2 ppm to 100 ppm in 6 ranges
 Conductivity: 2 electrodes 100 µS/cm-10 mS/cm, k=0.1 to 10 cm⁻¹
 Temperature

Correction variable

Temperature for pH and conductivity via Pt 100

Correction range

0 ... 100 °C

Control characteristic

P/PID control

Control

2-sided control

Signal current output

2 x 0/4-20 mA electrically isolated, range and assignment (measured or actuating variable) can be set

Control outputs

2 extra low voltage relays, 48 V with 1 A as a control output with pulse width modulation or limit value output

Electrical connection

24V DC, 3W, via DULCOPAC power supply unit

Permissible ambient temperature

-10...50 °C

Dimensions

60 x 90 x 55 mm (H x W x D)

Enclosure rating

IP 20

Weight

0.3 kg

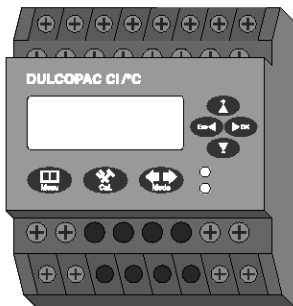

P_DM_0023_SW

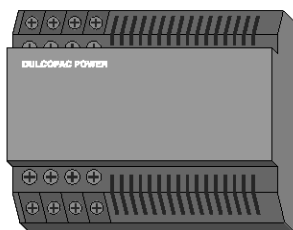

P_DM_0021_SW

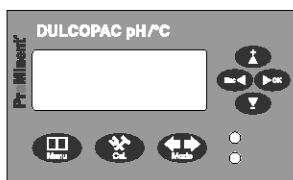

P_DM_0022_SW

	Order no.
DULCOPAC pH (mV)	1036425
DULCOPAC ORP/redox (mV)	1036427
DULCOPAC Chlorine	1036429
DULCOPAC Conductivity (direct)	1036431
DULCOPAC power supply unit, 230 V AC - 24 V DC	1036436





2.8 DULCOMETER® Transmitters

2.8.5 Application Examples for DULCOPAC

This chapter describes typical combinations of components for measuring stations with DULCOPAC transducers.

Measurement of pH with connection to a PLC

Tasks and applications

The pH value is to be measured in the bypass of a process water pipe, temperature 35 °C, pressure 3 bar, no solid matter content. The transducer is located in a control cabinet and the converted measuring signal is transmitted to a PLC as an analogue signal.

Components of the measuring/control station

Quantity	Name	See page	Order no.
1	DULCOPAC pH (mV)	→ 2-90	1036425
1	DULCOPAC power supply unit, 230 V AC - 24 V DC	→ 2-90	1036436
2 m	Coaxial cable, Ø 5 mm, 10.0 m	→ 1-119	305040
1	pH sensor PHEP 112 SE	→ 1-13	150041
1	Bypass fitting DGMA with sample water limit contact	→ 1-126	DGMa310T000

Measurement of free chlorine with connection to a PLC

Tasks and applications

The concentration of chlorine is to be measured in the bypass of a process water pipe. Chlorine concentration approx. 0.6 ppm, water temperature approx. 35 °C, total pressure approx. 1 bar, no solid matter. The transducer is located in a control cabinet and the converted measuring signal is transmitted to a PLC as an analogue signal.

Components of the measuring/control station

Quantity	Name	See page	Order no.
1	DULCOPAC Chlorine	→ 2-90	1036429
1	DULCOPAC power supply unit, 230 V AC - 24 V DC	→ 2-90	1036436
2 m	Two-wire measuring line 2 x 0.25 mm ² Ø 4 mm	→ 1-121	725122
1	Chlorine sensor CLE 3-mA-2 ppm	→ 1-51	792920
1	Bypass fitting DGMA	→ 1-126	DGMa 301T000

Measurement of conductive conductivity with connection to a PLC

Tasks and applications

The electrolytic conductivity is to be measured in the bypass of a process water pipe. Conductivity approx. 7500 µS/cm, water temperature approx. 35 °C, total pressure approx. 1 bar, no solid matter. The transducer is located in a control cabinet and the converted measuring signal is transmitted to a PLC as an analogue signal.

Components of the measuring/control station

Quantity	Name	See page	Order no.
1	DULCOPAC Conductivity (direct)	→ 2-90	1036431
1	DULCOPAC power supply unit, 230 V AC - 24 V DC	→ 2-90	1036436
1	Measuring line type LKT for conductivity sensors Ø 6.2 mm	→ 1-120	1046024
1	Conductivity LFT 1 DE	→ 1-100	1001376
1	Bypass fitting DGMA with sample water limit contact	→ 1-126	DGMa310T000

2.9 Measuring and Test Systems

2.9.1 Portable Meter Portamess® – Measured Variable pH/ORP

Robust manual measuring instrument to withstand the most severe mechanical and chemical loading.

Measuring range pH -2.00 to + 16.00, ORP -1,300 ... +1,300 mV

pH and ORP measurement with Portamess® pH/ORP - battery-powered, hand-held meter with automatic or manual temperature compensation.

The Portamess® pH/ORP is used to measure the pH and ORP value in the industrial, environmental, food and waste water sectors. The unit complies with the requirements of the EMC Act and the NAMUR NE 21 recommendations. Calibration can be done with buffer solutions made of different, pre-selectable buffer sets.

Your benefits

- Robust and protected against ingress (IP 66 protection)
- Long lifespan: Over 2,000 h operating time with only 3 x AA batteries
- Always in sight: Large LC display
- Hard-wearing membrane keypad
- Integrated sensor quiver to protect the sensor
- Robust, watertight, gold-plated sockets

Technical Details

- **Measuring ranges pH:** -2.00 ... +16.00, ORP: -1,300 ... +1,300 mV
- **Measuring errors pH:** < 0.01, ORP: < 0.1% of the measured value ±0.3 mV
- **Sensor adaptation:** 8 buffer sets to choose from
- **Temperature compensation:** manual
- **Protection class:** IP 66
- **Operating time:** 2,000 hours with 3 x AA cells
- **Dimensions:** H x W x D 160 x 133 x 30
- **Weight:** 560 g with batteries
- **Scope of delivery:** Measuring instrument, field case, operating instructions in German, English and French.

Field of application

- Industry
- Environmental protection
- Food production
- Water or waste water inspection

Order no.

Portamess® 911 pH

1008710

Accessories

	Capacity ml	Order no.
PHEKT-014F	–	1036537
Coaxial cable Ø 5 mm, 0.8 m - SD*	–	305098
Buffer pH 7.0	50	506253
Buffer pH 4.0	50	506251

* Fitting for all ProMinent® pH sensors with SN6 connection

Sensor quiver see p. → 2-98



pk_5_099





2.9 Measuring and Test Systems

2.9.2

Portable Meter Portamess® – Measured Variable Conductivity

Robust measuring instrument to withstand the most severe mechanical and chemical loading.

Measuring range 0.01 μ S/cm – 1,000 mS/cm

The measuring instrument Portamess® conductivity is a robust, leak-tight and battery-operated hand-held measuring instrument with a large measuring range and automatic or manual temperature compensation, which can be used in the industrial, environmental, food and waste water sectors.



pk_5_098

The Portamess® conductivity is used to measure conductivity and temperature in the industrial, environmental, food and waste water sectors. The unit complies with the requirements of the EMC Act and the NAMUR NE 21 recommendations. Calibration can be done with buffer solutions made of different, pre-selectable buffer sets.

Your benefits

- Robust and protected against ingress
- Long lifespan: Over 1,000 h operating time with only 3 x AA batteries
- Always in sight: Large LC display

Technical Details

Measuring ranges:

- Conductivity instrument: 0.01 μ S/cm ... 1,000 mS/cm, with sensor LF204: 1 μ S/cm ... 500 mS/cm
- Temperature: -20 ... 120 °C
- Salinity: 0.0 ... 45.0 g/kg (0 ... 30 °C)
- TDS: 0 ... 1,999 mg/l (10 ... 40 °C)

Measuring error:

- Conductivity < 0.5% of the measured value (with conductivities of > 500 mS/cm < 1% of the measured value) ± 1 digit
- Temperature < 0.3 K ± 1 digit

Sensor adaptation:

- Direct input of the cell constants, automatic establishment of the cell constants with KCl solution 0.01 or 0.1 mol/l, cell adaptation with any known solutions

Cell constant k:

- 0.010 ... 199.9 cm⁻¹ (adjustable)

Temperature compensation:

- Configurable, manual or measured

Protection class:

- IP 66

Operating time:

- Approx. 1,000 hours with 3 x AA cells

Dimensions:

- 160 x 133 x 30 mm (H x W x D)

Weight:

- 560 g with batteries

Scope of delivery:

- Measuring instrument, field case, conductivity sensor LF 204, operating instructions in German, English and French

Field of application

- Industry
- Environmental protection
- Food production
- Water or waste water inspection

Order no.

Portamess® 911 Cond

1008713

Note:

The scope of delivery does include the conductivity sensor LF 204.

Conductivity sensor LF 204 see p. → 2-98, Sensor quiver see p. → 2-98

2.9 Measuring and Test Systems

2.9.3

Photometer

Precise measurement results through high-quality interference filters

Photometers measure nearly all disinfectants and the pH value based on the photometric principle. They are portable, compact and make safe, simple measurement possible.

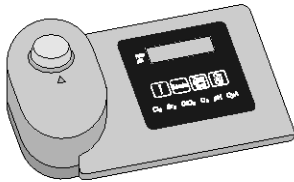

P_DT_0074_SW
Photometer

The Photometers DT1B, DT2C, DT3B and DT4B are used, among other things, as a reference method for calibrating the electrochemical sensors for chlorine, chlorine dioxide, fluoride, chlorite, H₂O₂, bromine and ozone. They have been adapted to today's requirements and can be used in almost all areas of water analysis. High-quality interference filters and long-term stable LEDs are used as the light source in the high-precision optics. The entire measuring unit is maintenance-free. Precise and reproducible analysis results are achieved with minimum time and effort. The units are winning customers over with their excellent operating convenience, ergonomic design, compact dimensions and ease of use.

Your benefits

- Portable and compact
- Simple to operate with text support
- Safe, simple measurement of chlorine, chlorine dioxide, fluoride, chlorite, H₂O₂, bromine, ozone, pH and trichloroisocyanuric acid
- Can be calibrated
- Memory function for the last measurements
- Backlit display
- Real-time clock
- Countdown
- Watertight, degree of protection IP 68

Technical Details

Measuring ranges of the DT1B:

- 0.05 ... 6.0 mg/l free chlorine (DPD1) + total chlorine (DPD1+3)
- 5 ... 200 mg/l free chlorine (high range)
- 0.1 ... 13.0 mg/l bromine (DPD1)
- 0.05 ... 11 mg/l chlorine dioxide (DPD1)
- 0.03 ... 4.0 mg/l ozone (DPD4)
- 6.5 ... 8.4 pH (phenol red)
- 1 ... 80 mg/l cyanuric acid

Measuring ranges of the DT2C:

- 0.05 ... 2.0 mg/l fluoride
- 0.05... 6.0 mg/l free chlorine and total chlorine
- 0.05 ... 11.0 mg/l chlorine dioxide

Measuring ranges of the DT3B:

- 1 ... 50 / 40 ... 500 mg/l hydrogen peroxide (H₂O₂)

Measuring ranges of the DT4B:

- 0.03 ... 2.5 mg/l chlorite
- 0.05 ... 11 mg/l chlorine dioxide
- 0.05 ... 6 mg/l chlorine

Measuring tolerance: Depending on the measured value and measuring method

Battery: 4 x AA/LR6 batteries

Permissible ambient temperature range: 5...40 °C

Relative humidity: 30 ... 90% (non-condensing)

Protection class: IP 68

Housing material: ABS

Keypad: Polycarbonate film

Dimensions: 190 x 110 x 55 mm (L x W x H)

Weight: 0.4 kg

Field of application

- Swimming pools
- Potable water
- Process water



2.9 Measuring and Test Systems

	Order no.
Photometer DT1B	1039315
Photometer DT3B hydrogen peroxide	1039317
Photometer DT4B	1039318

Photometers supplied with accessories, container vessels and reagents.

Consumable items

	Order no.
DPD1 tablets, 100 pieces *	1061892
DPD3 tablets, 100 pieces **	1061893
Glycine tablets, 20 pieces	1061944
Phenol red tablets 100 pieces	305532
Cyanuric acid tablets, 100 pieces	1039744
SPADNS reagent, 250 ml for fluoride detection	1010381
Calibration standard fluoride 1 mg/l, for calibration of the photometer during fluoride determination	1010382
3 pieces replacement cuvettes; round cuvettes with lid for DPD, phenol red and cyanuric acid detection (DT1, DT1B, DT4, DT4B, DT2B, DT2C)	1007566
3 pieces replacement cuvettes for fluoride detection (DT2B and DT2C)	1010396
Chlorine dioxide tablets No. 1, 250 no.	1039732
Chlorine dioxide tablets No. 2, 250 no.	1039733
Chlorine HR tablets, 100 pieces	1075056
Acidifying tablets, 100 pieces	1075057

* replaces DPD1 buffer, 15 ml (1002857) and DPD1 reagent, 15 ml (1002858)

** replaces DPD3 solution, 15 ml (1002859)

Spare parts

Chlorite measurement

	Order no.
Stirrer for purging of chlorine dioxide (DT4)	1022754
3 pieces replacement cuvettes; round cuvettes with lid for DPD, phenol red and cyanuric acid detection (DT1, DT1B, DT4, DT4B, DT2B, DT2C)	1007566

H₂O₂ measurement

	Order no.
Reagent for H ₂ O ₂ (DT3), 15 ml	1023636
Replacement cuvettes, 5 pieces, for H ₂ O ₂ (DT3)	1024072

2.10 Accessories for Measuring and Control Devices

2.10.1 Transmitter 4 ... 20 mA (Two-Wire System)

Benefits:

- Reliable signal transmission, even over large distances
- Interference-resistant 4 ... 20 mA signal
- Simple installation directly on the sensor

Typical applications:

Transmission of the measuring signal even over long distances and/or transmission of interference-resistant measured signals (e.g. pH, ORP) in conjunction with controllers type D1C, D2C and DULCOMARIN® or direct connection to PCs and/or a PLC. If using a PLC, it has to have an electrically isolated input.

pH measuring transducer 4 ... 20 mA type pH V1

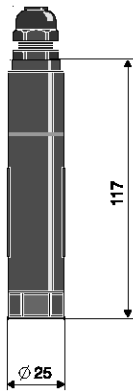

pk_5_064

Measuring range	pH 0 ... 14
Measuring error	< 0.1 pH (typical ±0.07 pH)
Socket	SN6
Input resistance	> 5 x 10 ¹¹ Ω
Signal current output	4 ... 20 mA ≈ -500 ... +500 mV ≈ pH 15.45 ... -1.45 not calibrated, not electrically isolated
Power supply DC	18...24 V DC
Ambient temperature	-5...50 °C, non-condensing
Enclosure rating	IP 65
Dimensions	141 mm (length), 25 mm (Ø)

Order no.

pH measuring transducer 4 ... 20 mA type pH V1	809126
--	--------

ORP measuring transducer 4 ... 20 mA type RH V1

Measuring range	0 ... 1000 mV
Measuring error	< ±5 mV (typical ±3 mV)
Socket	SN6
Input resistance	> 5 x 10 ¹¹ Ω
Signal current output	4 ... 20 mA ≈ 0 ... +1000 mV not electrically isolated
Power supply DC	18...24 V DC
Ambient temperature	-5...50 °C, non-condensing
Enclosure rating	IP 65
Dimensions	141 mm (length), 25 mm (Ø)

Order no.

ORP measuring transducer 4 ... 20 mA type RH V1	809127
---	--------

Temperature measuring transducer 4 ... 20 mA type Pt100 V1

Measuring range	0 ... 100 °C
Measuring error	< ±0.5 °C (typical ±0.3 °C)
Socket	SN6
Input resistance	~ 0 Ω
Signal current output	4 ... 20 mA ≈ 0 ... +100 °C not electrically isolated
Power supply DC	18...24 V DC
Ambient temperature	-5...50 °C, non-condensing
Enclosure rating	IP 65
Dimensions	141 mm (length), 25 mm (Ø)

Order no.

Temperature measuring transducer 4 ... 20 mA type Pt 100 V1	809128
---	--------





2.10 Accessories for Measuring and Control Devices

PEROX transducer

The microprocessor-based PEROX transducer is used to control and activate the PEROX sensor and to evaluate the sensor signal. It is screwed directly on to the sensor head. The H₂O₂ transducer can be directly connected to the D1C controller via a 3-core signal cable.

The PEROX transducer is approx. 205 mm long with a diameter of 32 mm.

PEROX transducer for H₂O₂ measurement

Contains an internal selector switch for the three ranges:

1 ... 20, 10 ... 200 and 100 ... 2,000 mg/l H₂O₂

	Order no.
PEROX transducer V2 for DACa and DACb	1047979

PEROX transducer V1 for D1Ca on request.

Accessory

	Order no.
Two-wire measuring line 2 x 0.25 mm² Ø 4 mm	725122

2.10 Accessories for Measuring and Control Devices

2.10.2

Accessories for Portable Meters Portamess®

Sensor quiver

5 pieces, for water tight storage of sensors. For Portamess® pH and Cond

Order no.

Sensor quiver

1008716

Conductivity sensor LF 204

Number of electrodes	4
Sensor shaft	Black epoxy
Sensors	Graphite
Shaft length	120 mm
Shaft diameter	15.3 mm
Cable length	1.5 m
Temperature sensor	NTC (30 kΩ) -5 ... 100 °C
Immersion depth min.	36 mm
Max. pressure	2 bar
Temperature	0 ... 90 °C
Cell constant	0.475 cm ⁻¹ ±1.5%
Measuring range	1 μS/cm...500 mS/cm

Order no.

Conductivity sensor LF 204

1008723



pk_5_093

3.0 Overview of Ordering System for Measuring and Control Points DULCOTROL® DWCa

3.0.1 Selection Guide

Measuring, control and monitoring tasks in water treatment

DULCOTROL® DWCa_P potable water/F&B	DULCOTROL® DWCa_W waste water
<p>Treatment of potable water, water similar to potable water and treatment of rinsing water, industrial and process water in the food and beverage industry</p> <ul style="list-style-type: none"> ■ Disinfection ■ Cleaning In Place (CIP) ■ pH adjustment ■ Monitoring 	<p>Treatment of industrial and municipal waste water</p> <ul style="list-style-type: none"> ■ pH neutralisation ■ Disinfection ■ Detoxification ■ Desalination of process water ■ Control of dissolved oxygen ■ Monitoring

3.0.2 Description of the Identity Code Specifications in the DULCOTROL® DWCa Ordering System

The measuring and control stations can be configured using the respective identity code ordering system. With the "panel-mounted" version, all the components except the sensors are mounted on a polypropylene panel. In the "assembly kit" version, all components are supplied loose in a package. The DULCOTROL® ordering system works with user-based selection criteria so that you can select the most appropriate measuring and control station, largely without any serious technical understanding. One or two measured variables can be configured in each product range. The identity code specifications are explained in more detail below. The content and scope of delivery contained in the specifications is described in Chapter 3.1.3 (Technical Description of the Scope of Delivery).

Specification: "Application"

The "Application" specification is used to define the application ("potable water", "waste water") in which the measuring and control station is deployed. This defines the types of sensors and fittings.

Specification: "Water to be measured"

This is used to further characterise the sample water (e.g. "clear water" or "turbid water") selected via the main application (e.g. potable water, waste water). The sensor type, measuring range (e.g. CLE 3-mA-2ppm) and fitting (e.g. DGMA) are defined in conjunction with the main application.

Specification: "Measured variable 1" and "Measured variable 2"

They are used to determine the measured variable to be measured or controlled (e.g. pH or chlorine). Up to two measured variables can be simultaneously selected within the scope of the specified options. This defines the sensor class (e.g. pH sensor or chlorine sensor) and the controller suitable for the measured variable and the appropriate measuring cable. We use the diaLog DACa controller for all measured variables except conductivity. We configure the Compact conductivity controller for the measured variable conductivity. The possible combinations of measured variables are listed in the tables in the "Technical Description of the Scope of Delivery" chapter.

Specification: "Measurement and control"

This determines whether only the measuring function or the complete bidirectional control function for the selected measured variable is shown on the controller.

Specification: "Communication interface"

This specification defines whether a PROFIBUS® DP interface is fitted on the controller.

Specification: "Data logger"

This specification defines whether a data logger is contained within the controller.

Specification: "Hardware expansion"

This specification defines whether a protective RC circuit is fitted to protect relays exposed to high loads.

Specification: "Sensor equipment"

This specification determines whether the measuring/control panel is supplied with or without sensors. If "with sensors" is selected, the sensors are also supplied in the original packaging. Select "without sensors" if the types of sensor supplied cannot be used as standard (see chapter 3.1.3: Technical Description of the Scope of Delivery) (for example: Inapplicable measuring range) or if the measuring plates are to be stored.



3.0 Overview of Ordering System for Measuring and Control Points DULCOTROL® DWCa

Specification: "Design"

This specification defines whether the measuring and control station is to be supplied as a completely assembled panel or an assembly kit and which label the panel is to have.

Specification: "Sample water treatment"

This specification defines whether a filter is fitted (for panel-mounted measuring and control points) or is supplied ready for connection (for assembly kits).

Specification: "Certification"

This specification defines the approvals and certificates.

Specification: "Documentation"

This specification defines the operating language of the controller and the operating instructions.





3.1 Measuring and Control Points DULCOTROL® DWCa_P Potable Water/F&B

3.1.1

Overview of DULCOTROL® DWCa_Potable Water/F&B

The compact measuring and control system for the reliable monitoring and treatment of potable and similar types of water.



Monitoring and treatment of potable and similar types of water with DULCOTROL® potable water/F&B – the compact measuring and control system specially designed for water treatment in waterworks and in the food and beverage industry.

Measuring and control systems DULCOTROL® for the potable water/F&B application are specially tailored to the potable water sector and the food and beverage industry. In addition, they also meet the particular requirements within these sectors: on the one hand, for potable water/product water treatment and, on the other hand, for the treatment of rinsing water, industrial water and process water. The measuring and control systems can be configured using the relevant identity code ordering system. With the "panel-mounted" version, all the components except the sensors are mounted on a polypropylene panel. In the "assembly kit" version, all components are supplied loose in a package. The DULCOTROL® ordering system works with user-based selection criteria so that you can select the most appropriate measuring and control system, largely without technical knowledge. One or two measured variables can be configured in each product range.

Your benefits

- Availability of all key chemical measured parameters for water treatment
- Application-optimised configuration of the components by user-based order criteria
- Configuration of 1 or 2 complete measuring and control points on a plate or as an assembly
- The equipment on the controllers can be selected
- Flexible use by designing the measuring and control point fully assembled or as an assembly
- Flexible adaptation to special applications and measuring ranges by designing the measuring and control points without sensors and ordering the sensor type and measuring range separately
- Ready-to-connect plug-and-play measuring and control points for quick, easy installation and commissioning
- Extensive optional accessories (pressure reducers, filters, heat exchangers, sample water pump)

Technical Details

- Installation in the bypass of the main water line through which the medium flows
- Max. pressure, depending on design: 1 bar/3 bar/6 bar
- Flow, depending on design: 15...40 l/h/ 40...65 l/h/
- Max. feed chemical temperature: primarily up to 45 °C, with some versions up to 65 °C (max. 2 bar)
- Ambient temperature: + 5...50 °C
- Degree of protection: IP65
- Power supply: 90 - 240 V, 50/60 Hz

Field of application

- Treatment of potable and product water (e.g. disinfection) in waterworks and domestic water installations
- Treatment of product water in the food and beverage industry
- Treatment of rinsing / industrial / process water for the food and beverage industry, e.g. cleaning and disinfection of pipework, vessels and machinery (cleaning in place)
- Monitoring of potable water distribution

3.1 Measuring and Control Points DULCOTROL® DWCa_P Potable Water/F&B

3.1.2 Permissible measured variable combinations for DULCOTROL® DWCa_P Potable water/F&B

Sample water 1: Potable water, product water

Measured variable 1 (channel 1)		Measured variable 2 (channel 2)													
		00	C0	C1	G0	P0	R0	D0	I0	L0	Z0	F0	H0	A0	X0
Free chlorine < pH 8	C0	x			x	x	x	x							
Free chlorine pH value > 8 and stable	C1	x			x	x	x	x							
Total chlorine (free and combined chlorine)	G0	x				x	x								
pH	P0	x				x									
ORP	R0	x				x									
Chlorine dioxide	D0	x				x	x			x					
Chlorite	I0	x													
Conductivity	L0	x				x	x								
Ozone	Z0	x				x	x								
Fluoride	F0	x				x									
Hydrogen peroxide	H0	x				x									
Peracetic acid	A0	x				x					x				
Dissolved oxygen	X0	x				x									

Sample water 2: Rinsing water, process water, industrial process water

Measured variable 1 (channel 1)		Measured variable 2 (channel 2)													
		00	C0	C1	G0	P0	R0	D0	I0	L0	Z0	F0	H0	A0	X0
Free chlorine < pH 8 and stable	C1	x				x	x								
Total chlorine (free and combined chlorine)	G0	x				x	x								
pH	P0	x				x									
ORP	R0	x				x									
Chlorine dioxide	D0	x				x	x								
Chlorite	I0	x													
Conductivity	L0	x				x	x								
Ozone	Z0	x				x	x								
Fluoride	F0	x				x									
Hydrogen peroxide	H0	x				x									
Peracetic acid	A0	x				x						x			

Sample water H: Potable and product water, 45 °C...65 °C

Measured variable 1 (channel 1)		Measured variable 2 (channel 2)													
		00	C0	C1	G0	P0	R0	D0	I0	L0	Z0	F0	H0	A0	X0
Free chlorine	C1	x				x									
pH	P0	x				x									
ORP	R0	x				x									
Conductivity	L0	x				x	x								

When ordering, state the identity code with the above order of measured variable 1/measured variable 2
i.e. DWCa P... C0_P0... and not DWCa P... P0_C0...

Other measured variable combinations on request.



3.1 Measuring and Control Points DULCOTROL® DWCa_P Potable Water/F&B

3.1.3 Identity Code Ordering System for DULCOTROL® DWCa_P Potable Water/F&B

DWCa	Application
P	Potable water
	Water to be measured
1	Potable water/product water
2	Rinsing water/industrial water/process water
H	Hot water to max. 65 °C, at max. 2 bar (measured variables C1, P0, R0, L0 only)
	Channel 1, measured variable 1
C0	Free chlorine < pH 8
C1	Free chlorine pH value > 8 and stable
G0	Total chlorine (free and combined chlorine)
P0	pH
R0	ORP
D0	Chlorine dioxide
I0	Chlorite
L0	Conductivity
Z0	Ozone
F0	Fluoride
H0	Hydrogen peroxide
A0	Peracetic acid
X0	Dissolved oxygen
	Channel 2, measured variable 2 (optional)
00	none
C0	Free chlorine < pH 8
C1	Free chlorine pH value > 8 and stable
G0	Total chlorine (free and combined chlorine)
P0	pH
R0	ORP
D0	Chlorine dioxide
I0	Chlorite
L0	Conductivity
Z0	Ozone
F0	Fluoride
H0	Hydrogen peroxide
A0	Peracetic acid
X0	Dissolved oxygen
	Measuring - Controlling
0	All measured variables measurable
9	All measured variables bidirectionally controllable
	Documentation language
DE	English
EN	English
ES	Spanish
IT	Italian
FR	French
FI	Finish
BG	Bulgarian
CN	Chinese
CZ	Czech
DK	Danish
EE	Estonian
GR	Greek
HU	Hungarian
JP	Japanese
KR	Korean
LT	Lithuanian
LV	Latvian
NL	Dutch
PL	Polish
PT	Portuguese
RO	Romanian
RU	Russian
SE	Swedish
SK	Slovakian
SL	Slovenian
SV	Swedish
TH	Thai
	Communication interface
0	Without
4	PROFIBUS®-DP*
	Data logger
0	Without
1	Data logger with measured value display on SD card
	Hardware expansion
0	Without
1	Protective RC circuit for output relay
	Sensor equipment
0	With sensors
1	Without sensors
	Version
0	Panel-mounted with ProMinent Logo
B	Assembly kit without panel with ProMinent logo
	Sample water treatments
0	Without
1	with filter (not for measured variable D0, Z0)
	Certifications
01	CE (Standard)

DWCa P 1 C0 P0 9 0 1 0 0 0 1 01 EN Identity code as a representative example

Permissible measured variable combinations for DULCOTROL® DWCa_P Potable water/F&B see → 3-4



3.1 Measuring and Control Points DULCOTROL® DWCa_P Potable Water/F&B

3.1.4 Examples of DULCOTROL® DWCa_P Potable Water/F&B

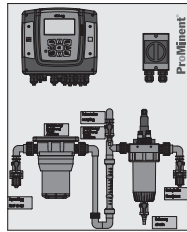

P_DCT_0035_SW1
similar figure

Example 1: DWCa_P_1_D0_I0_0_0_0_0_0_0_01_EN

Application in potable water/F&B:

Measurement of chlorine dioxide and chlorite in potable water/product water with an integrated data logger.

Controller

- DACa PA 6 1 4 0 0 0 0 1 0 0 1 0 EN

Fitting

- DGM_A_3_2_0_T_0_0_2:
 - 1 measuring module: Chlorine dioxide sensor
 - 1 measuring module: Chlorite sensor
 - 1 flow control module

Sensors

- CDE-2-mA 0.5 ppm
- CLT1-mA-0.5 ppm

Panel-mounted water treatment system

- Filter

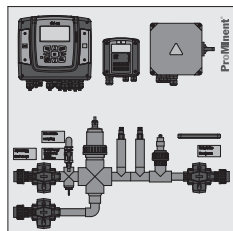

P_DCT_0036_SW1
similar figure

Example 2: DWCa_P_2_P0_C0_9_0_0_1_0_0_0_01_EN

Application in potable water/F&B:

Two-way control of pH and chlorine in rinsing water. The sample water is filtered through a 100 µm filter. The controller contains a relay protective RC circuit.

Controller

- DACa PA 6 1 4 0 0 0 0 0 1 0 1 0 EN

Fitting

- DLG III for pH and chlorine monitoring + flow control

Sensors

- CBR1-mA 2ppm
- PHER 112-SE

Panel-mounted water treatment system

- Filter

3





3.2 Measuring and Control Points DULCOTROL® DWCa_W Waste Water

3.2.1

Overview of DULCOTROL® DWCa_W Waste Water



The compact measuring and control system for the reliable monitoring and treatment of waste water.

Monitoring and treatment of waste water with DULCOTROL® Waste Water – the compact measuring and control system specially designed for applications in municipal and industrial waste water treatment.

The measuring and control systems DULCOTROL® waste water are used in all branches of industry where waste water is treated. All the necessary components are mounted on a polypropylene panel and ready to connect. The choice of components is matched to the application. The measuring and control systems can be configured using the relevant identity code ordering system. With the "panel-mounted" version, all the components except the sensors are mounted on a polypropylene panel. In the "assembly kit" version, all components are supplied loose in a package. The DULCOTROL® ordering system works with user-based selection criteria so that you can select the most appropriate measuring and control system, largely without technical knowledge. One or two measured variables can be configured in each product range.

Your benefits

- Availability of all key chemical measured parameters for water treatment
- Application-optimised configuration of components by user-based order criteria
- Configuration of 1 or 2 complete measuring and control points on a plate or as an assembly
- The equipment on the controllers can be selected
- Flexible use by designing the measuring and control point fully assembled or as an assembly
- Flexible adaptation to special applications and measuring ranges by designing the measuring and control points without sensors and ordering the sensor type and measuring range separately
- Ready-to-connect plug-and-play measuring and control points for quick, easy installation and commissioning
- Extensive optional accessories (pressure reducers, filters, heat exchangers, sample water pump)

Technical Details

- Installation in the bypass of the main water line through which the medium flows
- Max. pressure, depending on design: 1 bar/3 bar/6 bar
- Flow, depending on design: 15...40 l/h/ 40...65 l/h/ 300...500 l/h
- Max. feed chemical temperature: primarily up to 45 °C, with some versions up to 65 °C (max. 2 bar)
- Ambient temperature: + 5...50 °C
- Degree of protection: IP65
- Power supply: 90 - 240 V, 50/60 Hz

Field of application

- Treatment of industrial and municipal waste water
- pH neutralisation
- Disinfection
- Detoxification
- Desalination of process water
- Control of dissolved oxygen
- Monitoring

3.2 Measuring and Control Points DULCOTROL® DWCa_W Waste Water

3.2.2 Permissible measured variable combinations for DULCOTROL® DWCa_W Waste water

Sample water 4,5,7: clear and turbid waste water

Measured variable 1 (channel 1)		Measured variable 2 (channel 2)													
		00	C0	C1	G0	P0	R0	D0	I0	L0	Z0	F0	H0	A0	X0
Free chlorine < pH 8 and stable	C1	x				x	x								
Total chlorine (free and combined chlorine)	G0	x				x	x								
pH	P0	x				x									
ORP	R0	x				x									
Chlorine dioxide	D0	x					x	x							
Chlorite	I0	x													
Conductivity	L0	x				x	x								
Ozone	Z0	x				x	x								
Fluoride	F0	x				x									
Hydrogen peroxide	H0	x				x									
Peracetic acid	A0	x				x					x				

With sample water 6: waste water containing sludge

Measured variable 1 (channel 1)		Measured variable 2 (channel 2)													
		00	C0	C1	G0	P0	R0	D0	I0	L0	Z0	F0	H0	A0	X0
Free chlorine < pH 8 and stable	C1														
Total chlorine (free and combined chlorine)	G0														
pH	P0	x				x	x								
ORP	R0	x				x									
Chlorine dioxide	D0														
Chlorite	I0														
Conductivity	L0	x				x	x								x
Ozone	Z0														
Fluoride	F0														
Hydrogen peroxide	H0														
Peracetic acid	A0														
Dissolved oxygen	X0	x				x									

Sample water H: Potable and product water, 45 °C...65 °C

Measured variable 1 (channel 1)		Measured variable 2 (channel 2)													
		00	C0	C1	G0	P0	R0	D0	I0	L0	Z0	F0	H0	A0	X0
Free chlorine	C1	x				x									
pH	P0	x				x									
ORP	R0	x				x									
Conductivity	L0	x				x	x								

When ordering, state the identity code with the above order of measured variable 1/measured variable 2 i.e. DWCa W... C0_P0... and not DWCa W... P0_C0...

Other measured variable combinations on request.



3.2 Measuring and Control Points DULCOTROL® DWCa_W Waste Water

3.2.3 Identity Code Ordering System for DULCOTROL® DWCa_W Waste Water

DWCa	Application
W	Waste water
	Water to be measured
4	Clear waste water
5	Waste water with solid particle fraction, turbid
6	Waste water with solid particle fraction, containing sludge
7	Waste water, clear or turbid, with fluoride content and pH < 7
H	Hot water to max. 65 °C, at max. 2 bar (measured variables C1, P0, R0, L0 only)
	Channel 1, measured variable 1
C1	Free chlorine
G0	Total chlorine (free and combined chlorine)
P0	pH
R0	ORP
D0	Chlorine dioxide
I0	Chlorite
L0	Conductivity
Z0	Ozone
F0	Fluoride
H0	Hydrogen peroxide
A0	Peracetic acid
X0	Dissolved oxygen
	Channel 2, measured variable 2 (optional)
00	none
C1	Free chlorine
G0	Total chlorine (free and combined chlorine)
P0	pH
R0	ORP
D0	Chlorine dioxide
I0	Chlorite
L0	Conductivity
Z0	Ozone
F0	Fluoride
H0	Hydrogen peroxide
A0	Peracetic acid
X0	Dissolved oxygen
	Measuring - Controlling
0	All measured variables measurable
9	All measured variables bidirectionally controllable
	Documentation language
DE	English
EN	English
ES	Spanish
IT	Italian
FR	French
FI	Finish
BG	Bulgarian
CN	Chinese
CZ	Czech
DK	Danish
EE	Estonian
GR	Greek
HU	Hungarian
JP	Japanese
KR	Korean
LT	Lithuanian
LV	Latvian
NL	Dutch
PL	Polish
PT	Portuguese
RO	Romanian
RU	Russian
SE	Swedish
SK	Slovakian
SL	Slovenian
SV	Swedish
TH	Thai
	Communication interface
0	Without
4	PROFIBUS®-DP*
	Data logger
0	Without
1	Data logger with measured value display on SD card
	Hardware expansion
0	Without
1	Protective RC circuit for power relay
	Sensor equipment
0	With sensors
1	Without sensors
	Version
0	Panel-mounted with ProMinent Logo
B	Assembly kit without panel with ProMinent logo
(M)	Modified design
	Sample water treatments
0	Without
1	With filter(not with waste water = 6, not for measured variable D0, Z0)
	Certifications
01	CE (Standard)

DWCa W 1 C0 P0 9 0 1 0 0 0 1 01 EN Identity code as a representative example

Permissible measured variable combinations for DULCOTROL® DWCa_W Waste water see → 3-8



3.2 Measuring and Control Points DULCOTROL® DWCa_W Waste Water

3.2.4 Examples of DULCOTROL® DWCa_W Waste Water

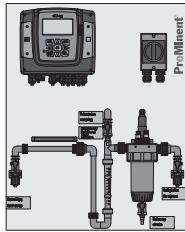

P_DCT_0037_SW1
Similar figure

Example 3: DWCa_W_5_H0_00_9_0_0_0_0_1_1_01_EN

Waste water application:

Two-way control of the hydrogen peroxide in turbid waste water. The controller contains a relay protective RC circuit and a data logger.

Controller

- DACa PA 6 1 0 0 0 0 0 1 1 0 1 0 EN

Fitting

- DLG III for hydrogen peroxide monitoring + flow control

Sensors

- PER1-mA-50 ppm

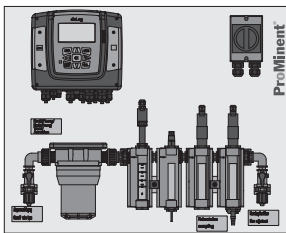

P_DCT_0038_SW1
similar figure

Example 4: DWCa_W_6_P0_L0_9_0_0_0_0_0_1_1_01_EN

Waste water application:

Bidirectional control of pH and measurement of conductivity in waste water containing sludge. The controller contains a relay protective RC circuit and a data logger.

Controller

- For pH: DACa PA 6 1 4 0 0 0 0 1 1 0 1 0 EN
- For conductivity: Compact controller

Fitting

- Piping + flow control

Sensors

- ICT 1
- PHEX 112-SE

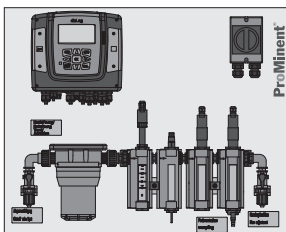

P_DCT_0038_SW1
similar figure



3.3 Technical Description of the Scope of Delivery of Measuring and Control Points DULCOTROL® DWCa

3.3.1 Technical Description of Controllers

(For detailed information see chap. Measuring and Control Technology)

The DULCOMETER® dialog DACa controller is used for measuring all measured variables with the exception of conductivity. The Compact controller is configured for conductivity measurement.

The DULCOMETER® diaLog DACa Controller used with the DULCOTROL® DWCa is available as a single or two-channel measuring and control device. The following versions of the device can be separately selected using the DULCOTROL® identity code ordering system:

- Specification: **Communication interface**
This specification defines whether a PROFIBUS® DP interface should be available on the controller.
- Specification: **Data logger**
This specification defines whether a data logger should be available on the controller.
- Specification: **Hardware extension**
This specification defines whether a protective RC circuit should be available to protect relays subject to higher loading.

Hardware version and identity code of diaLog DACa controllers:

Hardware version	Identity code for diaLog DACa controller
1-channel device without RC, without data logger	DACa PA 6 1 0 0 0 0 0 0 0 0 1 0 EN
1-channel device with RC, without data logger	DACa PA 6 1 0 0 0 0 0 0 1 0 1 0 EN
2-channel device without RC, without data logger	DACa PA 6 1 4 0 0 0 0 0 0 0 1 0 EN
2-channel device with RC, without data logger	DACa PA 6 1 4 0 0 0 0 0 1 0 1 0 EN
1-channel device without RC, with data logger	DACa PA 6 1 0 0 0 0 0 1 0 0 1 0 EN
1-channel device with RC, with data logger	DACa PA 6 1 0 0 0 0 0 1 1 0 1 0 EN
2-channel device without RC, with data logger	DACa PA 6 1 4 0 0 0 0 1 0 0 1 0 EN
2-channel device with RC, with data logger	DACa PA 6 1 4 0 0 0 0 1 1 0 1 0 EN
1-channel device, PROFIBUS® DP	DACa PA 6 1 0 0 0 0 4 0 0 0 1 0 EN
2-channel device, PROFIBUS® DP	DACa PA 6 1 4 0 0 0 4 0 0 0 1 0 EN
1-channel device with RC, PROFIBUS® DP	DACa PA 6 1 0 0 0 0 4 0 1 0 1 0 EN
2-channel device with RC, PROFIBUS® DP	DACa PA 6 1 4 0 0 0 4 0 1 0 1 0 EN
1-channel device, PROFIBUS® DP, with data logger	DACa PA 6 1 0 0 0 0 4 1 0 0 1 0 EN
1-channel device with RC, PROFIBUS® DP, with data logger	DACa PA 6 1 0 0 0 0 4 1 1 0 1 0 EN
2-channel device, PROFIBUS® DP, with data logger	DACa PA 6 1 4 0 0 0 4 1 0 0 1 0 EN
2-channel device with RC, PROFIBUS® DP, with data logger	DACa PA 6 1 4 0 0 0 4 1 1 0 1 0 EN

	Water to be measured	Order no.
Compact controller for conductive conductivity	1	DCCaW006L30010EN
Compact controller for inductive conductivity	2, 4, 5, 6, 7	DDCaW006L60010EN



3.3 Technical Description of the Scope of Delivery of Measuring and Control Points DULCOTROL® DWCa

3.3.2 Technical Description of Sensors

(For detailed information see chap. Sensor Technology DULCOTEST®)

The identity code specifications "Application", "Measured variable" and "Water to be measured" define the sensor type to be used as specified below in the tables.

If another sensor type is necessary, the measuring/control panel can also be supplied without sensors (see identity code specification: "Sensor equipment"). The desired sensor should then be ordered separately.

Sensor types for the defined specifications "measured variable" and "water to be measured" for the potable water ("P") application

Measured variable		Water to be measured	Sensor type	Order no.
Free chlorine with pH value < 8	C0	1	CLE 3-mA-0.5 ppm	792927
Free chlorine with pH value > 8	C1	1	CBR 1-mA-0.5 ppm	1038016
Free chlorine	C1	2	CBR 1-mA-2 ppm	1038015
Free chlorine	C1	H	CLO 2-mA-2 ppm	1033878
Total chlorine	G0	1	CTE 1-mA-0.5 ppm	740686
Total chlorine	G0	2	BCR 1-mA-2 ppm	1040115
pH	P0	1	PHEP 112 SE	150041
pH	P0	2	PHER 112 SE	1001586
ORP	R0	1	RHEP-Pt-SE	150094
ORP	R0	2	RHER-Pt-SE	1002534
ORP combined with ozone: R0 Z0	Z0	1/2	RHEP-Au-SE	1003875
Chlorine dioxide	D0	1	CDE 2-mA-0.5 ppm	792930
Chlorine dioxide (temperature-corrected)	D0	2	CDR 1-mA-2 ppm	1033393
Chlorite	I0	1/2	CLT 1-mA-0.5 ppm	1021596
Conductivity, conductive	L0	1	LFTK 1 DE	1002822
Conductivity, inductive	L0	2	ICT 1	1023244
Ozone	Z0	1/2	OZE 3-mA-2 ppm	792957
Fluoride (temp.corr.)	F0	1/2	FLEP 010-SE / FLEP 0100-SE	1028279
			Reference electrode REFP-SE	1018458
			Pt 100 SE	305063
			Measuring transducer 4-20 mA FPV1	1028280
Hydrogen peroxide	H0	1	PER 1-mA-200 ppm	1022509
Hydrogen peroxide	H0	2	PER 1-mA-2000 ppm	1022510
Peracetic acid	A0	1	PAA 1-mA-200 ppm	1022506
Peracetic acid	A0	2	PAA 1-mA-2000 ppm	1022507
Dissolved oxygen	X0	1/2	DO 1-mA-20 ppm	1020532





3.3 Technical Description of the Scope of Delivery of Measuring and Control Points DULCOTROL® DWCa

Sensor types for the defined specifications "measured variable" and "water to be measured" for the waste water ("W") application

Measured variable		Sample water	Sensor type	Order no.
pH	P0	4	PHEP 112 SE	150041
pH	P0	5	PHER 112 SE	1001586
pH	P0	6	PHEX 112 SE	305096
pH	P0	7	PHEF 012 SE	1010511
ORP	R0	4	RHEP-Pt-SE	150094
ORP	R0	5	RHER-Pt-SE	1002534
ORP	R0	6	RHEX-Pt-SE	305097
ORP combined with ozone: R0 Z0	Z0	1/2	RHEP-Au-SE	1003875
Fluoride (temp.corr.)	F0	4/5/7	FLEP 010-SE / FLEP 0100-SE	1028279
			Measuring transducer 4-20 mA FP 100 V1	1031331
			Reference electrode REFP-SE	1018458
Conductivity, inductive	L0	4/5/6/7	ICT 1	1023244
Total chlorine	G0	4/5	BCR 1-mA-2 ppm	1040115
Free chlorine	C1	4/5	CBR 1-mA-2 ppm	1038015
Free chlorine	C1	C1	CBR 1-mA-2 ppm	1033878
Hydrogen peroxide	H0	4/5	PER 1-mA-50 ppm	1030511
Dissolved oxygen	X0	4/5	DO 1-mA-20 ppm	1020532
Ozone	Z0	4/5	OZE 3-mA-2 ppm	792957
Chlorine dioxide (temperature-corrected)	D0	4/5	CDR 1-mA-2 ppm	1033393
Peracetic acid	A0	4/5	PAA 1-mA-200 ppm	1022506

3.3 Technical Description of the Scope of Delivery of Measuring and Control Points DULCOTROL® DWCa

3.3.3 Technical Description of Sensor Fittings

(For detailed information see chap. Sensor Technology DULCOTEST®)

The bypass fitting used depends in particular on the water to be measured but sometimes also on the measured variable or the combination of measured variables.

Sensor fittings in DULCOTROL® DWCa_P Potable water/F&B

Fitting type DGMA is used in the DULCOTROL® DWCa_P Potable water/F&B for all clear types of water similar to potable water. Fitting type DLG III is used for rinsing/industrial/process water with a turbid appearance in application "P".

Measured variable	Sample water	Sensor type
Free chlorine	1	DGMA
Total chlorine	1	DGMA
pH	1	DGMA
ORP	1	DGMA
Chlorine dioxide (CDE 2)	1	DGMA
Chlorite	1	DGMA
Conductivity	1	DGMA
Ozone	1	DGMA
Hydrogen peroxide	1	DGMA
Peracetic acid	1	DGMA
Temperature	1	DGMA
Free chlorine	2	DLGIII
Total chlorine	2	DLGIII
pH	2	DLGIII
ORP	2	DLGIII
Chlorine dioxide (CDR)	2	DLGIII
Chlorite	2	DLGIII
Ozone	2	DLGIII
Hydrogen peroxide	2	DLGIII
Peracetic acid	2	DLGIII
Temperature	2	DLGIII
Conductivity, inductive	2	ICT 3 in T-piece
Fluoride (temp.corr.)	1/2	DLGIV
Dissolved oxygen (DO1)	1	Adapter d75 pipe

Sensor fittings in DULCOTROL® DWCa_W Waste Water

Fitting type DLGIII is used in the DULCOTROL® DWCa_W Waste Water for all clear water or water with a minimal solid fraction. For sludge containing water in the "W" application the sensors are, wherever possible, fitted directly using adapters in the DN 40 PVC sample water line.

Measured variable	Sample water	Sensor type
Chlorine dioxide (CDR)	4/5	DLGIII
Fluoride	4/7	DLG IV (PVC) + magnetic stirrer
Dissolved oxygen (DO1)	4/5	Adapter for PVC pipe d75
Dissolved oxygen (DO2)	6	With pipe adapter for immersion pipe
Total chlorine	4/5	DLGIII
Conductivity, inductive (ICT 1)	4/5/6	Adapter for PVC pipe DN 40 (bypass on plate)
Ozone	4/5	DLGIII
ORP	6	T-piece / DN 40
ORP	4/5	DLGIII
Temperature	6	T-piece / DN 40
Temperature	4/5	DLGIII
Hydrogen peroxide	4/5	DLGIII
pH	6	T-piece / DN 40
pH	4/5/7	DLGIII



3.3 Technical Description of the Scope of Delivery of Measuring and Control Points DULCOTROL® DWCa

3.3.4 Technical Description of the Hydraulic Connector/Pipework

An 8 x 5 mm hose connector is used as the hydraulic connection for the sample water with "Water to be measured" 1, 2, 4, 5, 7 and a DN 25 connector for the "Water to be measured" 6 (containing sludge). Generally there is a shut-off ball valve fitted upstream and downstream of the bypass fitting. If ordered, a sample water filter is fitted upstream of the bypass fitting. The bypass fittings each contain a sampling tap. A metal pin is incorporated in the bypass fittings for potential equalisation.

3.3.5 Technical Description of Optional Accessories

Type		Sample water	Order no.
Pressure reducer DO 6F 1/2"	0.5 – 10 bar	1	302104
Pressure reducer V 82	0.5 – 10 bar	2	1031212
Sample water pump vonTaine® 0502 PP/FPM	Maximum flow, 1800 l/h; max. capacity: 4.5 m	1, 2, 4, 5, 7	1023089
Filter housing	–	1, 2, 4, 5, 7	1045244
Filter element	10 µm	1	1031210
Filter element	100 µm	2, 4, 5, 7	1031211



3.3 Technical Description of the Scope of Delivery of Measuring and Control Points DULCOTROL® DWCa

3



4.0 Measuring Control and Metering Systems for Swimming Pool Water Treatment

4.0.1

DULCODOS® Pool Swimming Pool Metering Systems

The metering systems DULCODOS® Pool ensure the best water quality. The systems are available in four different designs. It is easy to work out which type is best suited to your requirements.

??Chlorine or active oxygen?

Historically, swimming pool water has always been treated with chlorine. Because it is an effective disinfectant and is highly oxidising, chlorine is also the chemical of choice for public pools. Clear and hygienically safe water is guaranteed.

The metering systems DULCODOS® Pool reliably keep the operating parameters in an optimum range and unpleasant side-effects, such as the smell of chlorine or burning eyes, are very rare.

Active oxygen is less effective than chlorine. It can be used for very gentle and environmentally-sound water treatment in pools with fewer users.

■ Soft

DULCODOS® Pool Soft is especially suited to private pools used by a small number of people. It works with active oxygen substances, which are less effective than chlorine. Water treatment with active oxygen is a good alternative for ecologically-minded pool owners or if users are allergic to chlorine. DULCODOS® Pool Soft uses no chlorine chemicals.

■ Basic

DULCODOS® Pool Basic regulates the pH and chlorine content using the redox potential. This is the direct measurement of effective oxidation in the water and is therefore an indication of the disinfectant effect and concentration of the metered chlorine. The concentration of chlorine cannot be determined with accuracy with this process. ORP measurements allow a particular range of chlorine to be set. DULCODOS® Pool Basic is robust and requires little maintenance.

■ Comfort

DULCODOS® Pool Comfort uses highly specific chlorine sensors to measure the chlorine content. The concentration of chlorine in the water can be determined and set with accuracy. The effectiveness of the pool filter is boosted by an integrated feeder assembly for flocculant, resulting in crystal-clear water! Numerous features to enhance operating convenience, such as measured values being mapped by a screen plotter or remote control from your PC, iPad or other tablet device using an integrated web server, make the metering system very popular with customers.

■ Professional

In addition to the features described above, DULCODOS® Pool Professional also measures the combined chlorine. This is an important parameter in public pools. It can be incorporated in the building management system via OPC and KNX and alarm messages can be sent by text or e-mail. Eco!Mode operating mode reduces the energy consumption of the filter pumps. The integrated soft PLC control can be used to operate several peripheral devices and functions. The swimming pool controller becomes the central control unit for all the swimming pool technology.



4.0 Measuring Control and Metering Systems for Swimming Pool Water Treatment

■ Choice of pumps

The metering systems DULCODOS® Pool allow you to choose which metering pump to fit on your complete system. The choice of pump depends entirely on the size of your pool and how often it is used.

- **Peristaltic pumps DULCO®flex** are suited to applications requiring few chemicals, such as small pools or those used infrequently. The pump reliably eliminates bubbles of gas formed during periods of non-use. Depending on the amount of use, the metering hose has to be replaced once or twice a year.
- **Motor-driven metering pumps alpha** have a higher capacity and longer maintenance intervals. Like peristaltic pumps, they are silent.
- **Solenoid-driven metering pumps Beta®** are not controlled by switching them on and off, like DULCO®flex or alpha, instead, their metering frequency is adjusted continuously, enabling the pump to have an extremely precise control action.
- Pumps with **CAN bus system** can be used in the DULCODOS® Pool Professional series. They communicate all operating messages, such as two-stage monitoring of the chemical reservoir, to the control.

■ Accessories

Whether you are looking for collecting pans for chemical tanks or portable test devices for measurement parameters – or even software for digital control: optional accessories make it even easier for you to operate the system.

■ Service

Installation, commissioning, training in how the system works, operation and maintenance: When you buy a DULCODOS® Pool system, it comes with service you can rely on – even if your pool is already quite old.



4.1 Metering System DULCODOS® Pool Soft

4.1.1 Metering System DULCODOS® Pool Soft



Ecologically convincing: chlorine-free water treatment with active oxygen in private swimming pools.

For swimming pools with volumes up to 100 m³

Chlorine-free water treatment system for environmentally operated private pools. Safe water disinfection with active oxygen as a turnkey complete solution.

Complete system DULCODOS® Pool Soft for pH adjustment and chlorine-free disinfection with active oxygen. To prevent any germs in the pool from building up resistance to active oxygen, it is not metered continuously, but injected at intervals controlled by a timer.

Peristaltic pumps of the product range DULCO®flex, motor-driven metering pumps type alpha or solenoid-driven metering pumps type Beta® are used, depending on demand and the circulation volume.

Sensors, controllers and metering pumps form a unit with the chemical storage tanks, which can become operational without major installation work on your part.

The control device offers many deluxe functions, such as the recording of measured values on an SD memory card or remote access via the integral WEB server and LAN interface (optional).

Your benefits

- Simple, quick assembly
- Simple, menu-driven operation
- Chlorine-free
- Constantly good water quality
- Versatile monitoring functions

Technical Details

- 2-channel swimming pool controller Splash ControlPro+ with measurement/control of the pH value and metering of active oxygen using an integrated timer function, mounted on a wall plate ready for use.
- In-line probe housing with sample water monitoring, sample water filter and sensor for pH value
- Monitoring of the chemical reservoir
- Metering monitor to protect against over-metering
- Data logger with SD card
- Embedded web server with LAN interface (optional)
- Metering pumps alpha, DULCO®flex or Beta® to control the pH value and active oxygen content.
- Connector for point of injection: Injection valves with 1/2" screw thread
- Connectors for metering pumps/points of injection: PVC hose 10 x 4 mm
- Sample water connector: PE hose 8 x 5 mm
- Digital pause input
- Alarm relay output
- Electrical connection: 230 V AC, 50/60 Hz
- Dimensions with metering pumps alpha or Beta®:
 - 595 x 745 x 150 mm (W x H x D) mounting plate for measuring technology
 - 595 x 400 x 150 mm (W x H x D) mounting plate for pumps
- Dimensions with metering pumps DULCO®flex: 595 x 745 x 150 mm (W x H x D)
- Weight: approx. 10 kg or 6 kg (without pumps)

Field of application

- Private swimming pool

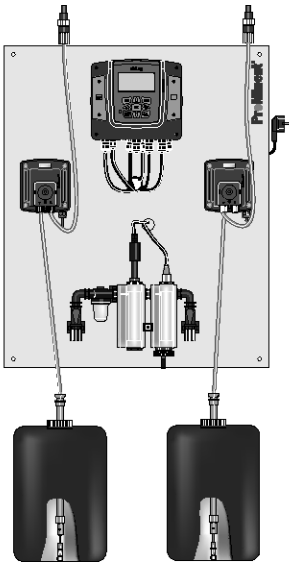

P_DD_0042_SW1



4.2 Metering System DULCODOS® Pool Basic

4.2.1 Metering System DULCODOS® Pool Basic



Convenient and simple: pure water in private swimming pools – fully automatically and correctly.
For swimming pools with a circulation capacity of up to 200 m³/h

The chlorine metering system DULCODOS® Pool Basic is a complete solution for private swimming pools where the chlorine content is controlled using the low-maintenance measurement of the ORP potential.

Complete system for the fully automatic adjustment of pH and chlorine content (using the measured variable redox potential) in swimming pool water. Peristaltic pumps of the product range DULCO®flex or motor-driven metering pumps type alpha are used, depending on demand and the circulation volume. Sensors, controllers and metering pumps form a single perfectly coordinated unit with the chemical storage tanks, which can reliably get to work without a lot of installation effort on your part.

Your benefits

- Simple, quick assembly
- Simple, menu-driven operation
- Constantly good water quality
- Versatile monitoring functions

Technical Details

- 2-channel swimming pool controller Splash Control with measurement, control and metering functions for pH and redox potential (chlorine metering)
- In-line probe housing with sample water monitoring, sample water filter and measuring probe for pH value and redox potential, fitted on a wall panel.
- 2 metering pumps alpha or DULCO®flex
- Monitoring of the chemical reservoir
- Metering monitor to protect against over-metering
- Connectors for points of injection: Injection valves with 1/2" screw thread
- Connectors for metering pumps/points of injection: PVC hose 10 x 4 mm
- Sample water connector: PE hose 8 x 5 mm
- Digital pause input
- Alarm relay output
- Electrical connection: 230 V AC, 50/60 Hz
- Dimensions: 595 x 745 x 150 mm (W x H x D)
- Weight: approx. 10 kg or 6 kg (without pumps)

Field of application

- Private swimming pool

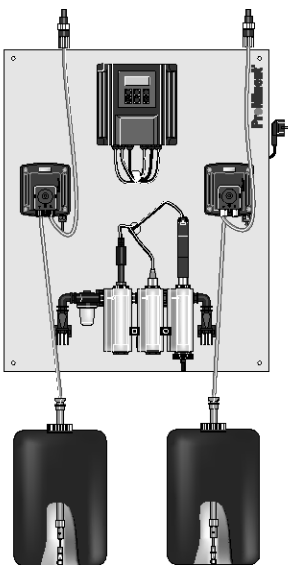

pk_7_100_SW1



4.3 Metering System DULCODOS® Pool Comfort

4.3.1 Metering System DULCODOS® Pool Comfort

Convenient and simple: crystal-clear water in private swimming pools.

For swimming pools with a circulation capacity of up to 225 m³/h

The chlorine metering system DULCODOS® Pool Comfort is the convenient solution for pH adjustment and disinfection of swimming pools with liquid chlorine products. Remote access is possible via LAN interface.



Your benefits

Complete system DULCODOS® Pool Comfort for pH adjustment and disinfection with liquid chlorine products. Peristaltic pumps of the product range DULCO®flex, motor-driven metering pumps type alpha or solenoid-driven metering pumps type Beta® are used, depending on demand and the circulation volume.

An integrated flocculant metering station (optional) ensures crystal-clear water.

Sensors, controllers and metering pumps form a unit with the chemical storage tanks, which can become operational without major installation work on your part.

The control device offers many deluxe functions, such as the recording of measured values on an SD memory card or remote access via the integral WEB server and LAN interface (optional).

- Simple, quick assembly
- Simple, menu-driven operation
- Brilliant water quality
- Versatile monitoring functions

Technical Details

- 2-channel controller (pH/ORP or pH/chlorine) or 3-channel controller (pH/ORP/chlorine) Splash Control Pro+ with measurement/control and metering functions for pH and chlorine concentration, ready mounted on a wall plate
- Integrated flocculant metering station (optional)
- In-line probe housing with sample water monitoring, sample water filter and measuring probes for pH and chlorine content (DC2 for free chlorine, DC4 for free chlorine in the presence of isocyanuric acid stabiliser)
- Monitoring of the chemical reservoir
- Metering monitor to protect against over-metering
- Data logger with SD card
- Embedded web server with LAN interface (optional)
- Metering pumps alpha, DULCO®flex or Beta® to control the pH value and chlorine content, DULCO®flex for metering flocculant (optional).
- Connector for point of injection: Injection valves with 1/2" screw thread
- Connectors for metering pumps/points of injection: PVC hose 10 x 4 mm
- Sample water connector: PE hose 8 x 5 mm
- Digital pause input
- Alarm relay output
- Electrical connection: 230 V AC, 50/60 Hz
- Dimensions with metering pumps alpha or Beta® and/or with "flocculant metering" option:
 - 595 x 745 x 150 mm (W x H x D) mounting plate for measuring technology
 - 595 x 400 x 150 mm (W x H x D) mounting plate for pumps
- Dimensions with metering pumps DULCO®flex: 595 x 745 x 150 mm (W x H x D)
- Weight: approx. 10 kg or 6 kg (without pumps)

Field of application

- High-end private pool

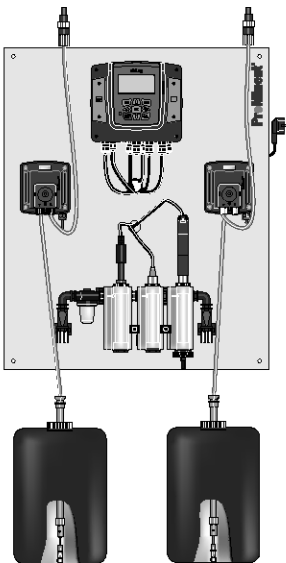

P_DD_0037_SW1

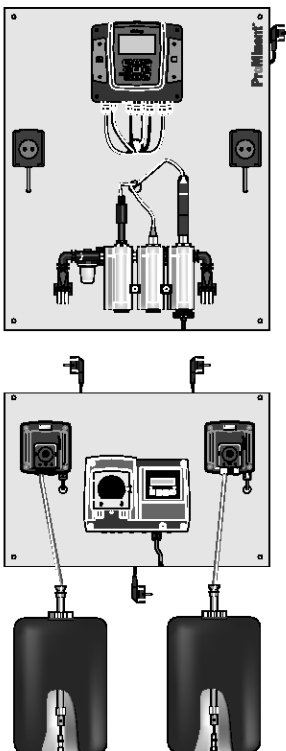

P_DD_0045_SW1



4.3 Metering System DULCODOS® Pool Comfort

Identity Code Ordering System for DULCODOS® Pool Comfort

DSPa	Measured variable
DR2	pH/ORP
DC2	pH / free chlorine (chlorine sensor CLE 3-mA-2ppm)
DC3	pH / ORP / free chlorine (chlorine sensor CLE 3-mA-2ppm)
DC4	pH / free chlorine in the presence of the stabiliser isocyanuric acid (chlorine sensor CGE 2-mA-2ppm)
Hardware-additional functions	
0	Standard
Software-additional functions	
1	Archiving of measured data including SD card
Communication interfaces	
0	none
7	Embedded web server, LAN
Electrical connection	
A	230 V, 50/60 Hz, European standard plug
B	230 V, 50/60 Hz, Swiss plug
Sensor equipment	
0	with sensors
B	Measured variable DC2 without sensors
C	Measured variable DC4 without sensors
Version	
0	with ProMinent® logo
1	without ProMinent® Logo
Language	
A	Swedish
D	German
E	English
F	French
G	Czech
I	Italian
N	Dutch
P	Polish
R	Russian
S	Spanish
Metering pumps for acids/alkalis	
0	without metering pumps
1	0.8 l/h (DULCO®flex DF2a 0208)
2	1.6 l/h (DULCO®flex DF2a 0216)
3	2.4 l/h (DULCO®flex DF2a 0224)
4	1.8 l/h (alpha ALPc 1002 PVT)
5	3.5 l/h (alpha ALPc 1004 PVT)
6	1.5 l/h (Beta® BT4b 0401 PVT)
7	2.8 l/h (Beta® BT4b 0402 PVT)
8	4.5 l/h (Beta® BT4b 0404 PVT)
Multifunctional valve for acid/alkali pump	
0	without
1	with MFV (only for alpha and Beta®)
Metering pumps for disinfection	
0	without metering pumps
1	0.8 l/h DULCO®flex for up to 45/10 m³/h circulation HB/FB*
2	1.6 l/h DULCO®flex for up to 90/20 m³/h circulation HB/FB*
3	2.4 l/h DULCO®flex for up to 140/30 m³/h circulation HB/FB*
4	1.8 l/h alpha for up to 100/20 m³/h circulation HB/FB*
5	3.5 l/h alpha for up to 200/40 m³/h circulation HB/FB*
6	1.5 l/h Beta® for up to 85/20 m³/h circulation HB/FB*
7	2.8 l/h Beta® for up to 160/35 m³/h circulation HB/FB*
8	4.5 l/h Beta® for up to 260/55 m³/h circulation HB/FB*
Multifunctional valve for disinfection pump	
0	without
1	with MFV (only for alpha and Beta®)
Installation	
0	supplied loose without mounting plate
1	assembled on a base plate
B	Base plate with flocculant pump DF4a fitted
Approvals	
0	with CE certification

DSPa DC4 0 1 0 A 0 0 E 2 0 2 0 1 0 Identity code as a representative example

* Calculated for 12 % sodium-calcium hypochlorite
 HB = Indoor swimming pool
 FB = Outdoor swimming pool



4.4 Metering System DULCODOS® Pool Professional

4.4.1 Metering System DULCODOS® Pool Professional



Professional and demanding: crystal-clear water in public swimming pools.

For swimming pools with a circulation capacity of up to 350 m³/h

Chlorine metering system for individual adjustment and monitoring of all common hygiene auxiliary parameters in public pools. DULCODOS® Pool Professional ensures crystal-clear water quality and lowers operating costs thanks to Eco!Mode.

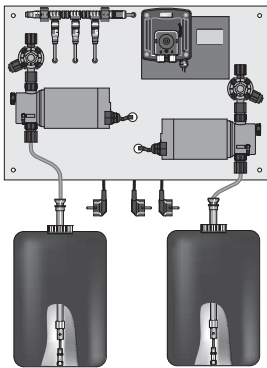
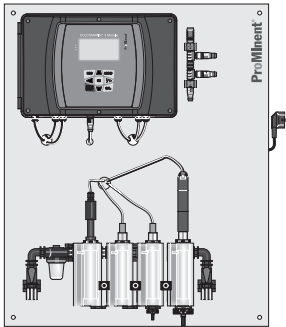

pk_7_105_SW1

Complete system DULCODOS® Pool Professional for individual adjustment and monitoring of all common hygiene auxiliary parameters in public pools, such as pH, redox potential and free and combined chlorine. Peristaltic pumps of the product range DULCO®flex, motor-driven metering pumps type alpha or solenoid-driven metering pumps type Beta® are used, depending on demand and the circulation volume.

An integrated flocculant metering station (optional) ensures crystal-clear water.

In Eco!Mode, the circulating volume of the swimming pool pumps is optimised depending on the water quality, enabling you to efficiently save energy.

The integrated SoftPLC allows the system to control optional peripheral devices and functions, such as UV systems, water attractions, lighting, heating and water top-up.

The system has many different communication interfaces that enable it to be integrated in networks or a building management system and it can also be remotely monitored and controlled with an Apple® iPad or tablet PC.

Sensors, controllers, metering pumps and the process chemical storage tanks form a single unit with the other peripheral swimming pool technology used, which can handle your work without a lot of installation effort on your part.

Your benefits

- Simple, quick assembly
- Brilliant water quality
- Eco!Mode helps cut operating costs
- Versatile communication interfaces
- Central control of peripheral devices and functions too

Technical Details

- Multi-channel, multi-parameter controller DULCOMETER® DULCOMARIN® 3 with measuring, control and metering functions for pH, redox potential, free and combined chlorine in various combinations depending on the type, ready-wired for use and mounted on a wall panel
- Optional integrated flocculant metering station
- In-line probe housing with sample water monitoring, sample water filter and all sensors
- Monitoring of the chemical reservoir with a pre-alarm (options A and F)
- Metering monitor to protect against over-metering
- Screen plotter for graphic mapping of measured values, data logger with SD card
- Embedded web server with LAN interface (optional)
- OPC and KNX for integration in building management systems, alarm function by text or e-mail (optional)
- Metering pumps alpha, DULCO®flex or Beta® to control the pH value and chlorine content, DULCO®flex for metering flocculant (optional)
- Connector for point of injection: Injection valves with 1/2" screw thread
- Connectors for metering pumps/points of injection: PVC hose 10 x 4 mm
- Sample water connector: PE hose 8 x 5 mm.
- Digital pause input
- 3 contact inputs, freely configurable (option A)
- 5 contact inputs, freely configurable (option F)
- CAN bus for connection of chlorine measuring cells and metering pumps Beta® and DULCO®flex DF4a
- Temperature measuring input Pt 100/Pt 1000
- 3 output relay outputs, freely configurable
- 3 relay outputs for the control of metering pumps (option A)
- 6 output relay outputs, freely configurable (option F)
- 4 analogue outputs 0/4-20 mA, freely configurable (option A)
- 2 analogue outputs 0/4-20 mA, freely configurable (option F)
- Electrical connection: 230 V AC, 50/60 Hz.
- Dimensions with metering pumps alpha, Beta® or DULCO®flex DF4a and/or with "flocculant metering" option:
 - 595 x 745 x 150 mm (W x H x D) mounting plate for measuring technology
 - 595 x 400 x 150 mm (W x H x D) mounting plate for pumps
- Dimensions with metering pumps DULCO®flex DF2a: 595 x 745 x 150 mm (W x H x D)
- Weight: approx. 12 kg or 7 kg (without pumps)



4.4 Metering System DULCODOS® Pool Professional

Field of application

- High-end private pool
- Public swimming pool
- Therapy pool

Type	pH	ORP	Measured variables:		
			Chlorine	Chlorine/isocyanuric acid	Combined chlorine
PC5	x	x			
PC6	x		x		
PC7	x	x	x		
PC8	x	x	x		x
PC9	x			x	
PCA	x	x		x	
PCD	x	x		x	x

Type PC5: pH and CRP potential (chlorine metering)

Type PC6: pH and free chlorine

Type PC7: pH, CRP potential and free chlorine

Type PC8: pH, CRP potential, free chlorine and combined chlorine

Type PC9: pH and free chlorine in the presence of the stabiliser isocyanuric acid

Type PCA: pH, CRP potential and free chlorine in the presence of the stabiliser isocyanuric acid

Type PCD: pH, CRP potential, free chlorine in the presence of the stabiliser isocyanuric acid and combined chlorine



4.4 Metering System DULCODOS® Pool Professional

Identity Code Ordering System for DULCODOS® Pool Professional

DSPa	Measured variable
PC5	pH / ORP
PC6	pH / free chlorine (chlorine sensor CLE 3.1-CAN)
PC7	pH / ORP / free chlorine (chlorine sensor CLE 3.1-CAN)
PC8	pH / ORP / free chlorine / total chlorine (chlorine sensors CLE 3.1-CAN and CTE 1-CAN)
PC9	pH / total chlorine (chlorine sensor CGE 2-CAN)
PCA	pH / ORP / total chlorine (chlorine sensor CGE 2-CAN)
PCD	pH / ORP / free chlorine / total chlorine (chlorine sensors CGE 2-CAN and CTE 1-CAN)
Hardware-additional functions	
0	Standard
A	4 standard signal outputs, 0/4-20 mA measured value
F	Functional module (F-module)
Software-additional functions	
1	Screen plotter with measured data backup including SD card
Communication interfaces	
0	none
5	Embedded web server, LAN
6	OPC server + Embedded web server + KNX function + alarm by text or e-mail
Electrical connection	
A	230 V, 50/60 Hz, European standard plug
B	230 V, 50/60 Hz, Swiss plug
Sensor equipment	
0	with sensors
A	Measured variable PC5 without sensors
E	Measured variable PC6 without sensors
F	Measured variable PC7 without sensors
G	Measured variable PC8 without sensors
H	Measured variable PC9 without sensors
I	Measured variable PCA without sensors
L	Measured variable PCD without sensors
Version	
0	with ProMinent® logo
1	without ProMinent® Logo
Language	
D	German
E	English
F	French
I	Italian
P	Polish
S	Spanish
Metering pumps for acids/alkalis	
0	without metering pumps
1	0.8 l/h (DULCO®flex DF2a 0208)
2	1.6 l/h (DULCO®flex DF2a 0216)
3	2.4 l/h (DULCO®flex DF2a 0224)
4	1.8 l/h (alpha ALPc 1002 PVT)
5	3.5 l/h (alpha ALPc 1004 PVT)
A	1.5 l/h (Beta® CANopen BT4a 0401 PVT)
B	2.8 l/h (Beta® CANopen BT4a 0402 PVT)
C	5.3 l/h (Beta® CANopen BT4a 0405 PVT)
D	1.5 l/h (DULCO®flex DF4a 04015 CAN Bus)
E	6.0 l/h (DULCO®flex DF4a 03060 CAN Bus)
F	8.3 l/h (Beta® CANopen BT4a 0408 PVT)
Multifunctional valve for acid/alkali pump	
0	without
1	with MFV (only for alpha and Beta®)
Metering pumps for disinfection	
0	without metering pumps
1	0.8 l/h DULCO®flex DF2a for up to 45/10 m³/h circulation HB/FB*
2	1.6 l/h DULCO®flex DF2a for up to 90/20 m³/h circulation HB/FB*
3	2.4 l/h DULCO®flex DF2a for up to 140/30 m³/h circulation HB/FB*
4	1.8 l/h alpha for up to 100/20 m³/h circulation HB/FB*
5	3.5 l/h alpha for up to 200/40 m³/h circulation HB/FB*
A	1.5 l/h Beta® CANopen for up to 85/20 m³/h circulation HB/FB*
B	2.8 l/h Beta® CANopen for up to 160/35 m³/h circulation HB/FB*
C	5.3 l/h Beta® CANopen for up to 300/65 m³/h circulation HB/FB*
D	1.5 l/h DULCO®flex DF4a CANopen for up to 85/20 m³/h circulation HB/FB*
E	6.0 l/h DULCO®flex DF4a CANopen for up to 340/70 m³/h circulation HB/FB*
F	19.5 l/h Beta® CANopen for up to 1050/225 m³/h circulation HB/FB*
Multifunctional valve for disinfection pump	
0	without
1	with MFV (only for alpha and Beta®)
Installation	
0	supplied loose without mounting plate
1	assembled on a base plate
C	Base plate with flocculant pump DF4a fitted
Approvals	
0	with CE certification

DSPa PC7 A 1 5 A 0 0 E B 0 B 0 1 0 Identity code as a representative example

* Calculated for 12% sodium-calcium hypochlorite

HB = Indoor swimming pool FB = Outdoor swimming pool



4.5 Maintenance Kits

The following are needed for the maintenance of a measuring, control and metering system DULCODOS® Pool:

- 2 pc. maintenance kits for metering pumps
- 1 pc. maintenance kit for the measured variable

4.5.1 Maintenance Kits for Metering Pumps

The following table shows the assignment of the maintenance kits to the types of metering pumps used.

	Product range	Type	Order no.
Hose, complete 4.8 x 8.0 PharMed	DF2a	0208, 0216, 0224	1009480
Hose, complete 1.6 x 4.8 PharMed	DF4a	04015	1030722
Hose, complete 3.2 x 6.4 PharMed	DF4a	03060	1030723
Spare parts kit 1005-2/1605-2 PVT	ALPc, BT4a	1002PVT/ 1004PVT (ALPc), 0405PVT (BT4a)	1023110
Spare parts kits 1601 – 2 PVT, PPT, NPT	BT4a, BT4b	0401PVT (BT4a), 0401PVT (BT4b)	1023108
Spare parts kits 1602 – 2 PVT, PPT, NPT	BT4a, BT4b	0402PVT (BT4a), 0402PVT (BT4b)	1023109
Spare parts kits 0708 – 2/1008 – 2 PVT, PPT, NPT	BT4a	0408PVT	1023111
Spare parts kit 9.2/33.5/12 x 9 PVT	BT4a	0220PVT	1023113
Spare parts kits 1604 – 2 PVT, PPT, NPT	BT4b	0404PVT	1035332

4.5.2 Maintenance Kits for Measured Variables

The following table shows the assignment of the maintenance kits to the types of DULCODOS® Pool.

Maintenance kits are put together for the measured variables of the DSPa. Depending on the measured variable, the maintenance kits consist of:

- Buffer solutions
- Electrolytes
- Diaphragm caps
- 1 stainless steel screen 300 µm for the water filter
- 1 NBR flat seal for the water filter

	Type	Order no.
DSPA maintenance kit PR0, PC5, 333, 335, 735, 736	Basic, Professional PC5	1050631
DSPA maintenance kit DO2	Soft	1050632
DSPA maintenance kit DC2, PC6, 640, 645, 745	Comfort DC2, Professional PC6	1050633
DSPA maintenance kit DC4, PC9	Comfort DC4, Professional PC9	1050644
DSPA maintenance kit PC7, PCB, 781, 785, 786	Professional PC7	1050645
DSPA maintenance kit PC8	Professional PC8	1050646
DSPA maintenance kit PCA	Professional PCA	1050647
DSPA maintenance kit PCD	Professional PCD	1050648

4.5.3 Buffer Solutions

Quality buffer solutions are provided for calibration of pH and ORP sensors.

The following table shows the assignment of the buffer solutions to the sensors.

	Measured variable	Order no.
Buffer solution pH 4, 50 ml, red	pH	506251
Buffer solution pH 7, 50 ml, green	pH	506253
Buffer solution ORP 465 mV, 50 ml	ORP	506240



4.6 Test Equipment

4.6.1 Portable Meter Portamess® – Measured Variable pH/ORP

Robust manual measuring instrument to withstand the most severe mechanical and chemical loading.

Measuring range pH -2.00 to + 16.00, ORP -1,300 ... +1,300 mV

pH and ORP measurement with Portamess® pH/ORP - battery-powered, hand-held meter with automatic or manual temperature compensation.



pk_5_099

The Portamess® pH/ORP is used to measure the pH and ORP value in the industrial, environmental, food and waste water sectors. The unit complies with the requirements of the EMC Act and the NAMUR NE 21 recommendations. Calibration can be done with buffer solutions made of different, pre-selectable buffer sets.

Your benefits

- Robust and protected against ingress (IP 66 protection)
- Long lifespan: Over 2,000 h operating time with only 3 x AA batteries
- Always in sight: Large LC display
- Hard-wearing membrane keypad
- Integrated sensor quiver to protect the sensor
- Robust, watertight, gold-plated sockets

Technical Details

- **Measuring ranges pH:** -2.00 ... +16.00, ORP: -1,300 ... +1,300 mV
- **Measuring errors pH:** < 0.01, ORP: < 0.1% of the measured value ±0.3 mV
- **Sensor adaptation:** 8 buffer sets to choose from
- **Temperature compensation:** manual
- **Protection class:** IP 66
- **Operating time:** 2,000 hours with 3 x AA cells
- **Dimensions:** H x W x D 160 x 133 x 30
- **Weight:** 560 g with batteries
- **Scope of delivery:** Measuring instrument, field case, operating instructions in German, English and French.

Field of application

- Industry
- Environmental protection
- Food production
- Water or waste water inspection

	Order no.
Portamess® 911 pH	1008710

Accessories

	Capacity ml	Order no.
PHEKT-014F	–	1036537
Coaxial cable Ø 5 mm, 0.8 m - SD*	–	305098
Buffer pH 7.0	50	506253
Buffer pH 4.0	50	506251

* Fitting for all ProMinent® pH sensors with SN6 connection

Sensor quiver see p. → 2-98



4.6 Test Equipment

4.6.2

Photometer

Precise measurement results through high-quality interference filters

Photometers measure nearly all disinfectants and the pH value based on the photometric principle. They are portable, compact and make safe, simple measurement possible.

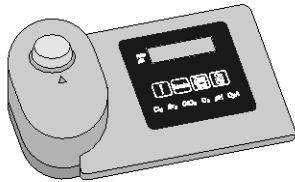

P_DT_0074_SW
Photometer

The Photometers DT1B, DT2C, DT3B and DT4B are used, among other things, as a reference method for calibrating the electrochemical sensors for chlorine, chlorine dioxide, fluoride, chlorite, H₂O₂, bromine and ozone. They have been adapted to today's requirements and can be used in almost all areas of water analysis. High-quality interference filters and long-term stable LEDs are used as the light source in the high-precision optics. The entire measuring unit is maintenance-free. Precise and reproducible analysis results are achieved with minimum time and effort. The units are winning customers over with their excellent operating convenience, ergonomic design, compact dimensions and ease of use.

Your benefits

- Portable and compact
- Simple to operate with text support
- Safe, simple measurement of chlorine, chlorine dioxide, fluoride, chlorite, H₂O₂, bromine, ozone, pH and trichloroisocyanuric acid
- Can be calibrated
- Memory function for the last measurements
- Backlit display
- Real-time clock
- Countdown
- Watertight, degree of protection IP 68

Technical Details

Measuring ranges of the DT1B:

- 0.05 ... 6.0 mg/l free chlorine (DPD1) + total chlorine (DPD1+3)
- 5 ... 200 mg/l free chlorine (high range)
- 0.1 ... 13.0 mg/l bromine (DPD1)
- 0.05 ... 11 mg/l chlorine dioxide (DPD1)
- 0.03 ... 4.0 mg/l ozone (DPD4)
- 6.5 ... 8.4 pH (phenol red)
- 1 ... 80 mg/l cyanuric acid

Measuring ranges of the DT2C:

- 0.05 ... 2.0 mg/l fluoride
- 0.05... 6.0 mg/l free chlorine and total chlorine
- 0.05 ... 11.0 mg/l chlorine dioxide

Measuring ranges of the DT3B:

- 1 ... 50 / 40 ... 500 mg/l hydrogen peroxide (H₂O₂)

Measuring ranges of the DT4B:

- 0.03 ... 2.5 mg/l chlorite
- 0.05 ... 11 mg/l chlorine dioxide
- 0.05 ... 6 mg/l chlorine

Measuring tolerance: Depending on the measured value and measuring method

Battery: 4 x AA/LR6 batteries

Permissible ambient temperature range: 5...40 °C

Relative humidity: 30 ... 90% (non-condensing)

Protection class: IP 68

Housing material: ABS

Keypad: Polycarbonate film

Dimensions: 190 x 110 x 55 mm (L x W x H)

Weight: 0.4 kg

Field of application

- Swimming pools
- Potable water
- Process water

4.6 Test Equipment

	Order no.
Photometer DT1B	1039315
Photometer DT3B hydrogen peroxide	1039317
Photometer DT4B	1039318

Photometers supplied with accessories, container vessels and reagents.

Consumable items

	Order no.
DPD1 tablets, 100 pieces *	1061892
DPD3 tablets, 100 pieces **	1061893
Glycine tablets, 20 pieces	1061944
Phenol red tablets 100 pieces	305532
Cyanuric acid tablets, 100 pieces	1039744
SPADNS reagent, 250 ml for fluoride detection	1010381
Calibration standard fluoride 1 mg/l, for calibration of the photometer during fluoride determination	1010382
3 pieces replacement cuvettes; round cuvettes with lid for DPD, phenol red and cyanuric acid detection (DT1, DT1B, DT4, DT4B, DT2B, DT2C)	1007566
3 pieces replacement cuvettes for fluoride detection (DT2B and DT2C)	1010396
Chlorine dioxide tablets No. 1, 250 no.	1039732
Chlorine dioxide tablets No. 2, 250 no.	1039733
Chlorine HR tablets, 100 pieces	1075056
Acidifying tablets, 100 pieces	1075057

* replaces DPD1 buffer, 15 ml (1002857) and DPD1 reagent, 15 ml (1002858)

** replaces DPD3 solution, 15 ml (1002859)

Spare parts

Chlorite measurement

	Order no.
Stirrer for purging of chlorine dioxide (DT4)	1022754
3 pieces replacement cuvettes; round cuvettes with lid for DPD, phenol red and cyanuric acid detection (DT1, DT1B, DT4, DT4B, DT2B, DT2C)	1007566

H₂O₂ measurement

	Order no.
Reagent for H ₂ O ₂ (DT3), 15 ml	1023636
Replacement cuvettes, 5 pieces, for H ₂ O ₂ (DT3)	1024072



4.6 Test Equipment



ProMinent® Chemical Resistance List

Resistance of Materials Used in Liquid Ends to the Chemicals Most Frequently Used

The data apply to standard conditions (20 °C, 1,013 mbar).

s	= saturated solution in water
+	= resistant
+/o	= largely resistant
o	= conditionally resistant
-	= not resistant
n	= resistance not known
=>	= see
*	= for bonded connections, the resistance of the adhesive (e.g. Tangit) is to be considered. (Materials of the types 'o' and '-' are not recommended!)
**	= does not apply to glass fibre reinforced material

Concentration data are stated in weight percent, relative to aqueous solutions. If percentages are stated for the level of resistance, this level of resistance is only valid up to this concentration.

NOTE:

The elastomers **CSM (Hypalon®)** and **IIR (butyl rubber)** used as diaphragm materials in pulsation dampers have properties similar to **EPDM**.

PTFE is resistant to all chemicals in this list.

PTFE filled with carbon, however, is attacked by strong oxidants such as bromine (anhydrous) or concentrated acids (phosphoric acid, sulphuric acid, chromic acid).

The resistance of PVC-U adhesive joints with Tangit deviates from the list below with regard to the following chemicals:

Medium	Concentration range
Sulfochromic acid	≥ 70% H ₂ SO ₄ + 5% K ₂ Cr ₂ O ₇ /Na ₂ Cr ₂ O ₇
Chromic acid	≥ 10% CrO ₃
Hydrochloric acid	≥ 25% HCl
Hydrogen peroxide	≥ 5% H ₂ O ₂
Hydrofluoric acid	≥ 0% HF

Explanation of abbreviations used as column headings:

PMMA:	Polymethylmethacrylate (Acrylic resistance)
PVC:	Polyvinylchloride, rigid, (PVC-U) resistance
PP:	Polypropylene resistance
PVDF:	Polyvinylidene fluoride
1.4404:	Stainless steel 1.4404 & 1.4571 resistance
FKM:	Fluorine Rubber (e.g. Viton® A & B) resistance
EPDM:	Ethylene-Propylene-Dien-rubber resistance
PharMed®:	PharMed® resistance
PE:	Polyethylene resistance
2.4819:	Hastelloy C-276 resistance
WGK:	Water endangering class

Viton® is a registered trademark of DuPont Dow Elastomers

Water endangering classes (WGK):

1	= slightly hazardous to water
2	= hazardous to water
3	= severely hazardous to water
(X)	= no classification. Classification according to conclusion by analogy. To be used under reserve.

Safety data sheets

Safety data sheets on our products in a number of different languages are provided on our website.

www.prominent.com/MSDS



ProMinent® Chemical Resistance List

The data is taken from relevant manufacturer's documentation and our own tests. Resistance of materials is also dependant on other factors, e.g. operating conditions, conditions of surfaces etc, and so this list must be treated as an initial guide only. It cannot claim to offer any guarantees. It should be taken into consideration in particular that usual dosing media are compounds, and their corrosiveness cannot be deducted simply by adding the corrosiveness of each single component. In such cases the chemical producers' data of the material compatibility are to be considered as a matter of prime importance for the material choice. A safety data sheet does not give this data and therefore cannot take the place of the technical documentation on the application.

Chemical	Formula	Conc	PMMA	PVC	PP	PVDF	1.4404	FKM	EPDM	PharMed®	PE	2.4819	WPC
Acetaldehyde	CH ₃ CHO	100%	-	-	o	-	+	-	+/o	-	+	+	2
Acetamide	CH ₃ CONH ₂	s	+	+	+	+	+	o	+	+/o	+	+	1
Acetic Acid	CH ₃ COOH	100%	-	50%	+	+	+	-	o	60%	70%	+	1
Acetic Anhydride	(CH ₃ CO) ₂ O	100%	-	-	o	-	+	-	+/o	+	o	+	1
Acetic Ether => Ethyl Acetate													
Acetone	CH ₃ COCH ₃	100%	-	-	+	-	+	-	+	-	+	+	1
Acetophenone	C ₆ H ₅ COCH ₃	100%	-	n	+	-	+	-	+	n	+	+	
Acetyl Chloride	CH ₃ COCl	100%	-	+	n	-	o	+	-	o	n	+	1
Acetylacetone	CH ₃ COCH ₂ COCH ₃	100%	-	-	+	-	+	-	+	n	+	+	1
Acetylene Dichloride => Dichloro Ethylene													
Acetylene Tetrachloride => Tetrachloro Ethane													
Acrylonitril	CH ₂ =CH-CN	100%	-	-	+	+	+	-	-	-	+	+	3
Adipic Acid	HOOC(CH ₂) ₄ COOH	s	+	+	+	+	+	+	+	+/o	+	+	1
Allyl Alcohol	CH ₂ CHCH ₂ OH	96%	-	o	+	+	+	-	+	o	+	+/o	2
Aluminium Acetate	Al(CH ₃ COO) ₃	s	+	+	+	+	+	+	+	+	+	+/o	1
Aluminium Bromide	AlBr ₃	s	+	+	+	+	n	+	+	+	+	+	2
Aluminium Chloride	AlCl ₃	s	+	+	+	+	-	+	+	+	+	+	1
Aluminium Fluoride	AlF ₃	10%	+	+	+	+	-	+	+	+	+	+/o	1
Aluminium Hydroxide	Al(OH) ₃	s	+	+	+	+	+	+	+	+	+	+	1
Aluminium Nitrate	Al(NO ₃) ₃	s	+	+	+	+	+	+	+	+	+	+	1
Aluminium Phosphate	AlPO ₄	s	+	+	+	+	+	+	+	+	+	+	1
Aluminium Sulphate	Al ₂ (SO ₄) ₃	s	+	+	+	+	+	+	+	+	+	+	1
Ammonium Acetate	CH ₃ COONH ₄	s	+	+/o	+	+	+	+	+	+	+	+	1
Ammonium Bicarbonate	NH ₄ HCO ₃	s	+	+	+	+	+	+	+	+	+	+	1
Ammonium Carbonate	(NH ₄) ₂ CO ₃	40%	+	+	+	+	+	+	+	+	+	+	1
Ammonium Chloride	NH ₄ Cl	s	+	+	+	+	-	+	+	+	+	+/o	1
Ammonium Fluoride	NH ₄ F	s	+	o	+	+	o	+	+	+	+	+	1
Ammonium Hydroxide	"NH ₄ OH"	30%	+	+	+	+(25°C)	+	-	+	+	+	+	2
Ammonium Nitrate	NH ₄ NO ₃	s	+	+	+	+	+	+	+	+	+	+	1
Ammonium Oxalate	(COONH ₄) ₂ * H ₂ O	s	+	+	+	+	+	+	+	+	+	+	1
Ammonium Perchlorate	NH ₄ ClO ₄	10%	+	+	+	+	+	+	+	+	+	+	1
Ammonium Peroxodisulphate	(NH ₄) ₂ S ₂ O ₈	s	+	+	+	+	5%	+	+	+	+	5%	2
Ammonium Phosphate	(NH ₄) ₃ PO ₄	s	+	+	+	+	10%	+	+	+	+	10%	1
Ammonium Sulphate	(NH ₄) ₂ SO ₄	s	+	+	+	+	10%	+	+	+	+	10%	1
Ammonium Sulphide	(NH ₄) ₂ S	s	+	+	+	+	n	+	+	n	+	n	2
Ammoniumaluminium Sulphate	NH ₄ Al(SO ₄) ₂	s	+	+	+	+	+	+	+	+	+	+	1
Amyl Alcohol	C ₅ H ₁₁ OH	100%	+	+	+	+	+	-	+	-	+	+	1
Aniline	C ₆ H ₅ NH ₂	100%	-	-	+	+	+	-	+/o	o	+	+	2
Aniline Hydrochloride	C ₆ H ₅ NH ₂ * HCl	s	n	+	+	+	-	+/o	+/o	o	+	+	2
Antimony Trichloride	SbCl ₃	s	+	+	+	+	-	+	+	+	+	n	2
Aqua Regia	3 HCl + HNO ₃	100%	-	+	-	+	-	-	o	-	-	-	2
Arsenic Acid	H ₃ AsO ₄	s	+	+	+	+	+	+	+	o	+	+	3
Barium Carbonate	BaCO ₃	s	+	+	+	+	+	+	+	+	+	+	1
Barium Chloride	BaCl ₂	s	+	+	+	+	-	+	+	+	+	+	1
Barium Hydroxide	Ba(OH) ₂	s	+	+	+	+	+	+	+	+	+	+	1
Barium Nitrate	Ba(NO ₃) ₂	s	+	+	+	+	+	+	+	+	+	+	1
Barium Sulphate	BaSO ₄	s	+	+	+	+	+	+	+	+	+	+	1
Barium Sulphide	BaS	s	+	+	+	+	+	+	+	+	+	+	(1)
Benzaldehyde	C ₆ H ₅ CHO	100%	-	-	+	-	+	+	+	-	o	+	1
Benzene	C ₆ H ₆	100%	-	-	o	+	+	o	-	-	o	+	3
Benzene Sulphonic Acid	C ₆ H ₅ SO ₃ H	10%	n	n	+	+	+	+	-	-	n	+	2
Benzoic Acid	C ₆ H ₅ COOH	s	+	+	+	+	+	+	+	+/o	+	+	1
Benzoyl Chloride	C ₆ H ₅ COCl	100%	-	n	o	n	o	+	+	n	o	+	2
Benzyl Alcohol	C ₆ H ₅ CH ₂ OH	100%	-	-	+	+	+	+	-	+	+	+	1
Benzyl Benzoate	C ₆ H ₅ COOC ₇ H ₇	100%	-	-	+	o	+	+	-	-	+	+	2
Benzyl Chloride	C ₆ H ₅ CH ₂ Cl	90%	-	n	o	+	+	+	-	-	o	+	2
Bitter Salt => Magnesium Sulphate													
Bleach => Sodium Hypochlorite													
Blue Vitriol => Copper Sulphate													
Borax => Sodium Tetraborate													



ProMinent® Chemical Resistance List

Chemical	Formula	Conc	PMMA	PVC	PP	PVDF	1.4404	FKM	EPDM	PharMed®	PE	2.4819	WPC
Boric Acid	H ₃ BO ₃	s	+	+	+	+	+	+	+	+	+	+	1
Brine		s	+	+/o	+	+	+/o	+	+	+	+	+	1
Bromine (dry)	Br ₂	100%	-	-	-	+	-	-	-	-	-	+	2
Bromine Water	Br ₂ + H ₂ O	s	-	+	-	+	-	-	-	n	-	n	(2)
Bromo Benzene	C ₆ H ₅ Br	100%	n	n	o	+	+	o	-	-	o	+	2
Bromochloro Methane	CH ₂ BrCl	100%	-	-	-	+	+	n	+/o	-	o	+	2
Bromochlorotrifluoro Ethane	HCCLBrCF ₃	100%	-	-	o	+	+	+	-	+	o	+	(3)
Butanediol	HOC ₄ H ₈ OH	10%	n	+	+	+	+	o	+	+	+	+	1
Butanetriol	C ₄ H ₁₀ O ₃	s	+	+	+	+	+	o	+	+	+	+	1
Butanol	C ₄ H ₉ OH	100%	-	+	+	+	+	o	+/o	-	+	+	1
Butyl Acetate	C ₇ H ₁₃ O ₂	100%	-	-	+	+	+	-	-	+/o	+	+	1
Butyl Acetate	CH ₃ COOC ₄ H ₉	100%	-	-	o	+	+	-	+/o	+/o	-	+	1
Butyl Alcohol => Butanol													
Butyl Amine	C ₄ H ₉ NH ₂	100%	n	n	n	-	+	-	-	n	+	+	1
Butyl Benzoate	C ₆ H ₅ COOC ₄ H ₉	100%	-	-	o	n	+	+	+	-	o	+	2
Butyl Mercaptane	C ₄ H ₉ SH	100%	n	n	n	+	n	+	-	n	n	n	3
Butyl Oleate	C ₂₂ H ₄₂ O ₂	100%	n	n	n	+	+	+	+/o	n	n	+	1
Butyl Stearate	C ₂₂ H ₄₄ O ₂	100%	o	n	n	+	+	+	-	n	n	+	1
Butyraldehyde	C ₃ H ₇ CHO	100%	-	n	+	n	+	-	+/o	-	+	+	1
Butyric Acid	C ₃ H ₇ COOH	100%	5%	20%	+	+	+	+	+	+/o	+	+	1
Calcium Acetate	(CH ₃ COO) ₂ Ca	s	+	+	+	+	+	+	+	+	+	+	1
Calcium Bisulphite	Ca(HSO ₃) ₂	s	+	+	+	+	+	+	+	+	+	+	(1)
Calcium Carbonate	CaCO ₃	s	+	+	+	+	+	+	+	+	+	+	1
Calcium Chloride	CaCl ₂	s	+	+	+	+	-	+	+	+	+	+	1
Calcium Cyanide	Ca(CN) ₂	s	+	+	+	+	n	+	+	+	+	n	3
Calcium Hydroxide	Ca(OH) ₂	s	+	+	+	+	+	+	+	+	+	+	1
Calcium Hypochlorite	Ca(OCl) ₂	s	+	+	o	+	-	o	+	+	+	+	2
Calcium Nitrate	Ca(NO ₃) ₂	s	+	50%	50%	+	+	+	+	+	+	+	1
Calcium Phosphate	Ca ₃ (PO ₄) ₂	s	+	+	+	+	+	+	+	+	+	+	1
Calcium Sulphate	CaSO ₄	s	+	+	+	+	+	+	+	+	+	+	1
Calcium Sulphide	CaS	s	+	+	+	+	n	+	+	+	+	+	(2)
Calcium Sulphite	CaSO ₃	s	+	+	+	+	+	+	+	+	+	+	(1)
Calcium Thiosulphate	CaS ₂ O ₃	s	+	+	+	+	-	+	+	+	+	+	1
Carbolic Acid => Phenole													
Carbon Disulphide	CS ₂	100%	-	-	o	+	+	+	-	-	o	+	2
Carbon Tetrachloride	CCl ₄	100%	-	-	-	+	+	+	-	-	o	+	3
Carbonic Acid	"H ₂ CO ₃ "	s	+	+	+	+	+	+	+	+	+	+	1
Caustic Potash => Potassium Hydroxide													
Caustic Soda => Sodium Hydroxide													
Chloric Acid	HClO ₃	20%	+	+	-	+	-	o	o	+	10%	+	2
Chlorinated Lime => Calcium Hypochlorite													
Chlorine Dioxide Solution	ClO ₂ + H ₂ O	0.5%	o	+	o	+ ¹⁾	-	o	-	-	o	+	
Chlorine Water	Cl ₂ + H ₂ O	s	+	+	o	+	-	+	+	-	o	+	
Chloro Benzene	C ₆ H ₅ Cl	100%	-	-	+	+	+	+	-	-	o	+	2
Chloro Ethanol	ClCH ₂ CH ₂ OH	100%	-	-	+	o	+	-	o	+	+	+	3
Chloro Ethylbenzene	C ₆ H ₄ ClC ₂ H ₅	100%	-	-	o	n	+	o	-	-	o	+	(2)
Chloro Phenole	C ₆ H ₄ OHCl	100%	-	n	+	+	+	n	-	-	+	+	2
Chloro Toluene	C ₇ H ₈ Cl	100%	-	-	n	+	+	+	-	-	n	+	2
Chloroacetone	ClCH ₂ COCH ₃	100%	-	-	n	n	+	-	+	-	n	+	3
Chlorobutadiene	C ₄ H ₅ Cl	100%	-	-	n	n	+	+	-	-	n	+	1
Chloroform	CHCl ₃	100%	-	-	o	+	+	+	-	o	-	+	2
Chlorohydrin	C ₃ H ₅ OCl	100%	-	n	+	-	+	+	o	+	+	+	3
Chloroprene => Chlorobutadiene													
Chlorosulphonic Acid	SO ₂ (OH)Cl	100%	-	o	-	+	-	-	-	-	-	o	1
Chrome-alum => Potassium Chrome Sulphate													
Chromic Acid	H ₂ CrO ₄	50%	-	+*	o	+	10%	+	-	o	+	10%	3
Chromic-Sulphuric Acid	K ₂ CrO ₄ + H ₂ SO ₄	s	-	+*	-	+	n	n	n	-	-	n	3
Chromium Sulphate	Cr ₂ (SO ₄) ₃	s	+	+	+	+	+	+	+	+	+	+	1
Citric Acid	C ₆ H ₈ O ₇	s	+	+	+	+	+	+	+	+	+	+	1
Cobalt Chloride	CoCl ₂	s	+	+	+	+	-	+	+	+	+	+	2
Copper-II-Acetate	Cu(CH ₃ COO) ₂	s	+	+	+	+	+	+	+	+	+	+	3
Copper-II-Arsenite	Cu ₃ (AsO ₃) ₂	s	+	+	+	+	+	+	+	+	+	+	3
Copper-II-Carbonate	CuCO ₃	s	+	+	+	+	+	+	+	+	+	+	2
Copper-II-Chloride	CuCl ₂	s	+	+	+	+	1%	+	+	+	+	+	2
Copper-II-Cyanide	Cu(CN) ₂	s	+	+	+	+	+	+	+	+	+	+	(3)
Copper-II-Fluoride	CuF ₂	s	+	+	+	+	+	+	+	+	+	+	(2)
Copper-II-Nitrate	Cu(NO ₃) ₂	s	+	+	+	+	+	+	+	+	+	+/o	2
Copper-II-Sulphate	CuSO ₄	s	+	+	+	+	+	+	+	+	+	+	2
Cresols	C ₆ H ₄ CH ₃ OH	100%	o	o	+	+	+	+	-	-	+	+	2



ProMinent® Chemical Resistance List

Chemical	Formula	Conc	PMMA	PVC	PP	PVDF	1.4404	FKM	EPDM	PharMed®	PE	2.4819	WPC
Crotonaldehyde	CH ₃ C ₂ H ₂ CHO	100%	n	-	+	+	+	-	+	-	+	+	3
Cubic Nitre => Sodium Nitrate													
Cumene => Isopropyl Benzene													
Cyclo Hexane	C ₆ H ₁₂	100%	+	-	+	+	+	+	-	-	+	o	1
Cyclohexanole	C ₆ H ₁₁ OH	100%	o	+/o	+	+	+	+	-	-	+	+	1
Cyclohexanone	C ₆ H ₁₀ O	100%	-	-	+	-	+	-	+/o	-	+	+	1
Cyclohexyl Alcohol => Cyclohexanol													
Cyclohexylamine	C ₆ H ₁₁ NH ₂	100%	n	n	n	n	+	-	n	n	n	+	2
Decahydronaphthaline	C ₁₀ H ₁₈	100%	-	+/o	o	+	n	o	-	-	o	+	2
Decaline => Decahydronaphthalene													
Dextrose => Glucose													
Diacetonol	C ₆ H ₁₂ O ₂	100%	-	-	+	o	+	-	+	-	+	+	1
Dibromoethane	C ₂ H ₄ Br ₂	100%	-	-	n	+	+	+	-	-	-	+	3
Dibutyl Ether	C ₄ H ₉ OC ₄ H ₉	100%	-	-	+	+	+	-	o	-	+	+	2
Dibutyl Phthalate	C ₁₆ H ₂₂ O ₄	100%	-	-	+	+	+	+	+/o	+	o	+	2
Dibutylamine	(C ₄ H ₉) ₂ NH	100%	n	n	+	+	+	-	-	n	+	+	1
Dichloro Acetic Acid	Cl ₂ CHCOOH	100%	-	+	+	+	+	-	+	o	+	+	1
Dichloro Benzene	C ₆ H ₄ Cl ₂	100%	-	-	o	+	+	+	-	-	o	+	2
Dichloro Butan	C ₄ H ₈ Cl ₂	100%	-	-	o	+	+	+	-	-	o	+	3
Dichloro Butene	C ₄ H ₆ Cl ₂	100%	-	-	o	+	+	o	-	-	o	+	3
Dichloro Ethane	C ₂ H ₄ Cl ₂	100%	-	-	o	+	+	+	-	o	-	+	3
Dichloro Ethylene	C ₂ H ₂ Cl ₂	100%	-	-	o	+	+	o	-	o	-	+	2
Dichloro Methane	CH ₂ Cl ₂	100%	-	-	o	o	o	+	-	o	-	+	2
Dichloroisopropyl Ether	(C ₃ H ₆ Cl) ₂ O	100%	-	-	o	n	+	o	o	-	o	+	(2)
Dicyclohexylamine	(C ₆ H ₁₂) ₂ NH	100%	-	-	o	n	+	-	-	-	o	+	2
Diethyleneglycol	C ₄ H ₁₀ O ₃	s	+	+	+	+	+	+	+	+	+	+	1
Diethyleneglycolethyl Ether	C ₆ H ₁₈ O ₃	100%	n	n	+	+	+	n	+/o	o	+	+	1
Diethylether	C ₂ H ₅ OC ₂ H ₅	100%	-	-	o	+	+	-	-	o	o	+	1
Diglycolic Acid	C ₄ H ₆ O ₅	30%	+	+	+	+	+	+	n	+/o	+	+	3
Dihexyl Phthalate	C ₂₀ H ₂₆ O ₄	100%	-	-	+	+	+	-	n	+	+	+	(1)
Diisobutylketone	C ₉ H ₁₈ O	100%	-	-	+	+	+	-	+	-	+	+	1
Di-iso-nonyl Phthalate	C ₂₆ H ₄₂ O ₄	100%	-	-	+	+	+	n	n	+	+	+	1
Diisopropylketone	C ₇ H ₁₄ O	100%	-	-	+	+	+	-	+	-	+	+	1
Dimethyl Carbonate	(CH ₃ O) ₂ CO	100%	n	n	+	+	+	+	-	n	+	+	1
Dimethyl Ketone => Acetone													
Dimethyl Phthalate	C ₁₀ H ₁₀ O ₄	100%	-	-	+	+	+	-	+/o	+	+	+	1
Dimethylformamide	HCON(CH ₃) ₂	100%	-	-	+	-	+	-	+	+/o	+	+	1
Dimethylhydrazine	H ₂ NN(CH ₃) ₂	100%	n	n	+	n	+	-	+	n	+	+	3
Dioctyl Phthalate	C ₄ H ₄ (COOC ₈ H ₁₇) ₂	100%	-	-	+	+	+	-	+/o	+	+	+	1
Dioxane	C ₄ H ₈ O ₂	100%	-	-	o	-	+	-	+/o	-	+	+	1
Disodium Hydrogenphosphate	Na ₂ HPO ₄	s	+	+	+	+	+	+	+	+	+	+	1
Disulfur Acid -- Oleum													
Disulphur Dichloride	S ₂ Cl ₂	100%	n	n	n	+	n	+	-	-	n	n	
DMF => Dimethylformamide													
Engine Oils		100%	n	+/o	+	+	+	+	-	-	+	+	2
Epsom salts => Magnesium Sulphate													
Ethanol	C ₂ H ₅ OH	100%	-	+	+	+	+	-	+	+	+	+	1
Ethanol Amine	HOC ₂ H ₄ NH ₂	100%	o	n	+	-	+	-	+/o	o	+	+	1
Ethyl Acetate	CH ₃ COOC ₂ H ₅	100%	-	-	35%	+	+	-	+/o	+/o	+	+	1
Ethyl Acrylate	C ₂ H ₃ COOC ₂ H ₅	100%	-	-	+	o	+	-	+/o	-	+	+	2
Ethyl Benzene	C ₆ H ₅ -C ₂ H ₅	100%	-	-	o	+	+	o	-	-	o	+	1
Ethyl Benzoate	C ₆ H ₅ COOC ₂ H ₅	100%	n	-	+	o	+	+	-	-	+	+	1
Ethyl Bromide	C ₂ H ₅ Br	100%	-	n	+	+	n	+	-	o	+	+	2
Ethyl Chloroacetate	ClCH ₂ COOC ₂ H ₅	100%	-	o	+	+	+	+	-	-	+	+	2
Ethyl Chlorocarbonate	ClCO ₂ C ₂ H ₅	100%	n	n	n	n	n	+	-	n	n	n	(2)
Ethyl Cyclopentane	C ₅ H ₄ C ₂ H ₅	100%	+	+	+	+	+	+	-	-	+	+	(1)
Ethylacetoacetate	C ₆ H ₁₀ O ₃	100%	n	-	+	+	+	-	+/o	+/o	+	+	1
Ethylacrylic Acid	C ₄ H ₇ COOH	100%	n	n	+	+	+	n	+/o	n	+	+	(1)
Ethylene Diamine	(CH ₂ NH ₂) ₂	100%	o	o	+	-	o	-	+	n	+	o	2
Ethylene Dibromide => Dibromoethane													
Ethylene Dichloride => Dichloro Ethane													
Ethylene Glycol => Glycol													
Ethylenglycol Ethylether	HOC ₂ H ₄ OC ₂ H ₅	100%	n	n	+	+	+	n	+/o	o	+	+	1
Ethylhexanol	C ₈ H ₁₆ O	100%	n	+/o	+	+	+	+	+	-	+	+	2
Fatty Acids	R-COOH	100%	+	+	+	+	+	+	o	o	+	+	1
Ferric Chloride	FeCl ₃	s	+	+	+	+	-	+	+	+	+	+/o	1
Ferric Nitrate	Fe(NO ₃) ₃	s	+	+	+	+	+	+	+	+	+	+	1
Ferric Phosphate	FePO ₄	s	+	+	+	+	+	+	+	+	+	+	1
Ferric Sulphate	Fe ₂ (SO ₄) ₃	s	+	+	+	+	+	+	+	+	+	+	1

ProMinent® Chemical Resistance List

Chemical	Formula	Conc	PMMA	PVC	PP	PVDF	1.4404	FKM	EPDM	PharMed®	PE	2.4819	WPC
Ferrous Chloride	FeCl ₂	s	+	+	+	+	-	+	+	+	+	+/o	1
Ferrous Sulphate	FeSO ₄	s	+	+	+	+	+	+	+	+	+	+	1
Fixing Salt => Sodium Thiosulphate													
Fluoro Benzene	C ₆ H ₅ F	100%	-	-	+	+	+	o	-	-	o	+	2
Fluoroboric Acid	HF ₄	35%	+	+	+	+	o	+	+	-	+	+	1
Fluorosilicic Acid	H ₂ SiF ₆	100%	+	30%	30%	+	o	+	+	o	40%	+/o	2
Formaldehyde	CH ₂ O	40%	+	+	+	+	+	-	+/o	-	+	+	2
Formalin => Formaldehyde													
Formamide	HCONH ₂	100%	+	-	+	+	+	+	+	n	+	+	1
Formic Acid	HCOOH	s	-	+/o	+	+	+	-	-	+/o	+	+	1
Furane	C ₄ H ₄ O	100%	-	-	+	-	+	-	n	-	+	+	3
Furane Aldehyde	C ₅ H ₅ O ₂	100%	n	n	n	o	+	-	+/o	-	n	n	2
Furfuryl Alcohol	OC ₄ H ₃ CH ₂ OH	100%	-	-	+	o	+	n	+/o	-	+	+	1
Gallic Acid	C ₆ H ₂ (OH) ₃ COOH	5%	+	+	+	+	+	+	+/o	+	+	+	1
Gasoline		100%	-	-	+	+	+	+	-	-	+	+	2
Glauber's Salt => Sodium Sulphate													
Glucose	C ₆ H ₁₂ O ₆	s	+	+	+	+	+	+	+	+	+	+	1
Glycerol	C ₃ H ₅ (OH) ₃	100%	+	+	+	+	+	+	+	+	+	+	1
Glycerol Triacetate	C ₃ H ₅ (CH ₃ COO) ₃	100%	n	n	+	+	+	-	+	n	+	+	1
Glycine	NH ₂ CH ₂ COOH	10%	+	+	+	+	+	+	+	+	+	+	1
Glycol	C ₂ H ₄ (OH) ₂	100%	+	+	+	+	+	+	+	+	+	+	1
Glycolic Acid	CH ₂ OHCOOH	70%	+	37%	+	+	+	+	+	+/o	+	+	1
Gypsum => Calcium Sulphate													
Heptane	C ₇ H ₁₆	100%	+	+	+	+	+	+	-	-	+	+	1
Hexachloroplatinic Acid	H ₂ PtCl ₆	s	n	+	+	+	-	n	+	n	+	-	
Hexanal	C ₆ H ₁₁ CHO	100%	n	n	+	+	+	-	+/o	-	+	+	1
Hexane	C ₆ H ₁₄	100%	+	+	+	+	+	+	-	-	+	+	1
Hexanol	C ₆ H ₁₃ OH	100%	-	-	+	+	+	n	+	o	+	+	1
Hexantriol	C ₆ H ₉ (OH) ₃	100%	n	n	+	+	+	+	+	n	+	+	1
Hexene	C ₆ H ₁₂	100%	n	+	+	+	+	+	-	-	+	+	1
Hydrazine Hydrate	N ₂ H ₄ * H ₂ O	s	+	+	+	+	+	n	+	o	+	+	3
Hydrobromic Acid	HBr	50%	+	+	+	+	-	-	+	-	+	o	1
Hydrochloric Acid	HCl	38%	32%	+*	+	+	-	+	o	o	+	o	1
Hydrofluoric Acid	HF	80%	-	40%*	40%**	+	-	+	o	-	40%	+/o	1
Hydrogen Cyanide	HCN	s	+	+	+	+	+	+	+	+	+	+	3
Hydrogen Peroxide	H ₂ O ₂	90%	40%	40%*	30%	+	+	30%	30%	+	+	+	1
Hydroiodic Acid	HI	s	+	+	+	+	-	-	n	-	+	n	1
Hydroquinone	C ₆ H ₄ (OH) ₂	s	o	+	+	+	+	+	-	+/o	+	+	2
Hydroxylamine Sulphate	(NH ₂ OH) ₂ * H ₂ SO ₄	10%	+	+	+	+	+	+	+	+	+	+	2
Hypochlorous Acid	HOCl	s	+	+	o	+	-	+	+/o	+	o	+	(1)
Iodine	I ₂	s	o	-	+	+	-	+	+/o	+	o	+/o	
Iron Vitriol => Ferrous Sulphate													
Isobutanol => Isobutyl Alcohol													
Isobutyl Alcohol	C ₂ H ₅ CH(OH)CH ₃	100%	-	+	+	+	+	+	+	o	+	+	1
Isopropanol => Isopropyl Alcohol													
Isopropyl Acetate	CH ₃ COOCH(CH ₃) ₂	100%	-	-	+	+	+	-	+/o	+/o	+	+	1
Isopropyl Alcohol	(CH ₃) ₂ CHOH	100%	-	+/o	+	+	+	+	+	o	+	+	1
Isopropyl Benzene	C ₆ H ₅ CH(CH ₃) ₂	100%	-	-	o	+	+	+	-	-	o	+	1
Isopropyl Chloride	CH ₃ CHClCH ₃	80%	-	-	o	+	+	+	-	o	o	+/o	2
Isopropyl Ether	C ₆ H ₁₄ O	100%	-	-	o	+	+	-	-	o	o	+	1
Kitchen Salt => Sodium Chloride													
Lactic Acid	C ₃ H ₆ O ₃	100%	-	+	+	+	+/o	+	10%	+/o	+	+	1
Lead Acetate	Pb(CH ₃ COO) ₂	s	+	+	+	+	+	+	+	+	+	+	2
Lead Nitrate	Pb(NO ₃) ₂	50%	+	+	+	+	+	+	+	+	+	+	2
Lead Sugar => Lead Acetate													
Lead Sulphate	PbSO ₄	s	+	+	+	+	+	+	+	+	+	+	(2)
Lead Tetraethyl	Pb(C ₂ H ₅) ₄	100%	+	+	+	+	+	+	-	n	+	+	3
Lime Milk => Calcium Hydroxide													
Liquid Ammonia => Ammonium Hydroxide													
Lithium Bromide	LiBr	s	+	+	+	+	+	+	+	+	+	+	1
Lithium Chloride	LiCl	s	+	+	+	+	-	+	+	+	+	n	1
Lunar Caustic => Silver Nitrate													
Magnesium Carbonate	MgCO ₃	s	+	+	+	+	+	+	+	+	+	+/o	1
Magnesium Chloride	MgCl ₂	s	+	+	+	+	o	+	+	+	+	+	1
Magnesium Hydroxide	Mg(OH) ₂	s	+	+	+	+	+	+	+	+	+	+	1
Magnesium Nitrate	Mg(NO ₃) ₂	s	+	+	+	+	+	+	+	+	+	+	1
Magnesium Sulphate	MgSO ₄	s	+	+	+	+	+	+	+	+	+	+/o	1
Maleic Acid	C ₄ H ₄ O ₄	s	+	+	+	+	+	+	+	o	+	+	1
Malic Acid	C ₄ H ₆ O ₅	s	+	+	+	+	+	+	+	+	+	+	1



ProMinent® Chemical Resistance List

Chemical	Formula	Conc	PMMA	PVC	PP	PVDF	1.4404	FKM	EPDM	PharMed®	PE	2.4819	WPC
Manganese-II-Chloride	MnCl ₂	s	+	+	+	+	-	+	+	+	+	+	1
Manganese-II-Sulphate	MnSO ₄	s	+	+	+	+	+	+	+	+	+	+	1
MEK => Methyl Ethyl Ketone													
Mercury	Hg	100%	+	+	+	+	+	+	+	+	+	+	3
Mercury-II-Chloride	HgCl ₂	s	+	+	+	+	-	+	+	+	+	+	3
Mercury-II-Cyanide	Hg(CN) ₂	s	+	+	+	+	+	+	+	+	+	+	3
Mercury-II-Nitrate	Hg(NO ₃) ₂	s	+	+	+	+	+	+	+	+	+	+	3
Mesityl Oxide	C ₆ H ₁₀ O	100%	-	-	n	n	+	-	+/o	-	n	+	1
Methacrylic Acid	C ₃ H ₅ COOH	100%	n	n	+	+	+	o	+/o	+/o	+	+	1
Methanol	CH ₃ OH	100%	-	-	+	+	+	o	+	+/o	+	+	1
Methoxybutanol	CH ₃ O(CH ₂) ₄ OH	100%	-	-	+	+	+	+	o	o	+	+	(1)
Methyl Acetate	CH ₃ COOCH ₃	60%	-	-	+	+	+	-	+/o	+/o	+	+	2
Methyl Acrylate	C ₂ H ₃ COOCH ₃	100%	-	-	+	+	+	-	+/o	o	+	+	2
Methyl Benzoate	C ₆ H ₅ COOCH ₃	100%	-	-	+	o	+	+	-	-	+	+	2
Methyl Catechol	C ₆ H ₃ (OH) ₂ CH ₃	s	+	+	+	+	+	+	-	+o	+	+	(1)
Methyl Cellulose		s	+	+	+	+	+	+	+	+	+	+	1
Methyl Chloroacetate	ClCH ₂ COOCH ₃	100%	-	o	+	+	+	o	-	-	+	+	2
Methyl Cyclopentane	C ₅ H ₉ CH ₃	100%	+	+	+	+	+	+	-	-	+	+	(1)
Methyl Dichloroacetate	Cl ₂ CHCOOCH ₃	100%	-	-	+	n	+	-	n	-	+	+	2
Methyl Ethyl Ketone	CH ₃ COC ₂ H ₅	100%	-	-	+	-	+	-	+	-	+	+	1
Methyl Glycol	C ₃ H ₈ O ₂	100%	+	+	+	+	+	-	+/o	+	+	+	1
Methyl Isobutyl Ketone	CH ₃ COC ₄ H ₉	100%	-	-	+	-	+	-	o	-	+	+	1
Methyl Isopropyl Ketone	CH ₃ COC ₃ H ₇	100%	-	-	+	-	+	-	+/o	-	+	+	1
Methyl Methacrylate	C ₃ H ₅ COOCH ₃	100%	-	-	+	+	+	-	-	-	+	+	1
Methyl Oleate	C ₁₇ H ₃₃ COOCH ₃	100%	n	n	+	+	+	+	+/o	n	+	+	1
Methyl Salicylate	HOC ₆ H ₄ COOCH ₃	100%	-	-	+	+	+	n	+/o	-	+	+	1
Methylacetyl Acetate	C ₅ H ₈ O ₃	100%	-	-	+	+	+	-	+/o	o	+	+	2
Methylamine	CH ₃ NH ₂	32%	+	o	+	o	+	-	+	+	+	+	2
Methylene Chloride => Dichloro Methane													
Mirabilit => Sodium Sulphate													
Morpholine	C ₄ H ₉ ON	100%	-	-	+	-	+	n	n	-	+	+	2
Muriatic Acid => Hydrochloric Acid													
Natron => Sodium Bicarbonate													
Nickel-II-Acetate	(CH ₃ COO) ₂ Ni	s	+	+	+	+	+	-	+	+	+	+	(2)
Nickel-II-Chloride	NiCl ₂	s	+	+	+	+	-	+	+	+	+	+	2
Nickel-II-Nitrate	Ni(NO ₃) ₂	s	+	+	+	+	+	+	+	+	+	+/o	2
Nickel-II-Sulphate	NiSO ₄	s	+	+	+	+	+	+	+	+	+	+/o	2
Nitrate of Lime => Calcium Nitrate													
Nitric Acid	HNO ₃	99%	10%	10%*	50%	65%	50%	65%	10%	35%	50%	65%	1
Nitro Methane	CH ₃ NO ₂	100%	-	-	+	o	+	-	+/o	-	+	+	2
Nitro Propane	(CH ₃) ₂ CHNO ₂	100%	-	-	+	n	+	-	+/o	-	+	+	2
Nitro Toluene	C ₆ H ₄ NO ₂ CH ₃	100%	-	-	+	+	+	o	-	-	+	+	2
Octane	C ₈ H ₁₈	100%	o	+	+	+	+	+	-	-	+	+	1
Octanol	C ₈ H ₁₇ OH	100%	-	-	+	+	+	+	+	-	+	+	1
Octyl Cresol	C ₁₅ H ₂₄ O	100%	-	-	+	+	+	o	n	-	+	+	(1)
Oil => Engine Oils													
Oleum	H ₂ SO ₄ + SO ₃	s	n	-	-	-	+	+	-	+	-	+	2
Orthophosphoric Acid => Phosphoric Acid													
Oxalic Acid	(COOH) ₂	s	+	+	+	+	10%	+	+	+/o	+	+/o	1
Pentane	C ₅ H ₁₂	100%	+	+	+	+	+	+	-	-	+	+	1
Pentanol => Amyl Alcohol													
Perchloric Acid	HClO ₄	70%	n	10%	10%	+	-	+	+/o	+	+	n	1
Perchloroethylene => Tetrachloro Ethylene													
Perhydrol => Hydrogen Peroxide													
Petroleum Ether	C _n H _{2n+2}	100%	+	+/o	+	+	+	+	-	-	+	+	1
Phenole	C ₆ H ₅ OH	100%	-	-	+	+	+	+	-	+	+	+	2
Phenyl Ethyl Ether	C ₆ H ₅ OC ₂ H ₅	100%	-	-	+	n	+	-	-	-	+	+	2
Phenyl Hydrazine	C ₆ H ₅ NHNH ₂	100%	-	-	o	+	+	o	-	-	o	+	2
Phosphoric Acid	H ₃ PO ₄	85%	50%	+	+	+	+	+	+	+	+	+	1
Phosphorous Oxychloride	POCl ₃	100%	-	-	+	+	n	+	+	n	+	+	1
Phosphorous Trichloride	PCl ₃	100%	-	-	+	+	+	o	+	+/o	+	+	1
Phthalic Acid	C ₆ H ₄ (COOH) ₂	s	+	+	+	+	+	+	+	+	+	+	1
Picric Acid	C ₆ H ₂ (NO ₃) ₃ OH	s	+	+	+	+	+	+	+	+	+	+	2
Piperidine	C ₅ H ₁₁ N	100%	-	-	n	n	+	-	-	-	n	+	2
Potash Alum => Potassium Aluminium Sulphate													
Potassium Acetate	CH ₃ COOK	s	+	+	+	+	+	+	+	+	+	+	1
Potassium Aluminium Sulphate	KAl(SO ₄) ₂	s	+	+	+	+	+	+	+	+	+	+	1
Potassium Bicarbonate	KHCO ₃	40%	+	+	+	+	+	+	+	+	+	+/o	1
Potassium Bifluoride	KHF ₂	s	n	+	+	+	+	+	+	+	+	+	1



ProMinent® Chemical Resistance List

Chemical	Formula	Conc	PMMA	PVC	PP	PVDF	1.4404	FKM	EPDM	PharMed®	PE	2.4819	WPC
Potassium Bisulphate	KHSO ₄	5%	+	+	+	+	+	+	+	+	+	+	1
Potassium Bitartrate	KC ₄ H ₅ O ₆	s	+	+	+	+	+	+	+	+	+	+	1
Potassium Borate	KBO ₂	s	+	+	+	+	+	+	+	+	+	+	(1)
Potassium Bromate	KBrO ₃	s	+	+	+	+	+	+	+	+	+	+	2
Potassium Bromide	KBr	s	+	+	+	+	10%	+	+	+	+	0.1	1
Potassium Carbonate	K ₂ CO ₃	s	+	+	+	+	+	+	+	55%	+	+	1
Potassium Chlorate	KClO ₃	s	+	+	+	+	+	+	+	+	+	+	2
Potassium Chloride	KCl	s	+	+	+	+	-	+	+	+	+	+/o	1
Potassium Chromate	K ₂ CrO ₄	10%	+	+	+	+	+	+	+	+	+	+	3
Potassium Chrome Sulphate	KCr(SO ₄) ₂	s	+	+	+	+	+	+	+	+	+	+	1
Potassium Cyanate	KOCN	s	+	+	+	+	+	+	+	+	+	+	2
Potassium Cyanide	KCN	s	+	+	+	+	5%	+	+	+	+	5%	3
Potassium Cyanoferrate II	K ₄ Fe(CN) ₆	s	+	+	+	+	+	+	+	+	+	+	1
Potassium Cyanoferrate III	K ₃ Fe(CN) ₆	s	+	+	+	+	+	+	+	+	+	+	1
Potassium Dichromate	K ₂ Cr ₂ O ₇	s	+	+	+	+	25%	+	+	+	+	10%	3
Potassium Fluoride	KF	s	+	+	+	+	+	+	+	+	+	+	1
Potassium Hydroxyde	KOH	50%	+	+	+	+	+ (25 °C)	+	-	+	10%	+	1
Potassium Iodide	KI	s	+	+	+	+	+	+	+	+	+	+	1
Potassium Nitrate	KNO ₃	s	+	+	+	+	+	+	+	+	+	+	1
Potassium Perchlorate	KClO ₄	s	+	+	+	+	n	+	+	+	+	+	1
Potassium Permanganate	KMnO ₄	s	+	+	+	+	+	+	+	6%	+	+	2
Potassium Persulphate	K ₂ S ₂ O ₈	s	+	+	+	+	+	+	+	+	+	+	1
Potassium Phosphate	KH ₂ PO ₄	s	+	+	+	+	+	+	+	+	+	+	1
Potassium Pyrochromate => Potassium Dichromate													
Potassium Sulphate	K ₂ SO ₄	s	+	+	+	+	+	+	+	+	+	+	1
Potassium Sulphite	K ₂ SO ₃	s	+	+	+	+	+	+	+	+	+	+	1
Propionic Acid	C ₂ H ₅ COOH	100%	o	+	+	+	+	+	+	+	+/o	+	1
Propionitrile	CH ₃ CH ₂ CN	100%	n	n	+	+	+	+	-	-	+	+	2
Propyl Acetate	CH ₃ COOC ₃ H ₇	100%	-	-	+	+	+	-	+/o	-	+	+	1
Propylene Glycol	CH ₃ CHOHCH ₂ OH	100%	+	+	+	+	+	+	+	+	+	+	1
Prussic Acid => Hydrogen Cyanide													
Pyridine	C ₅ H ₅ N	100%	-	-	o	-	+	-	-	o	+	+	2
Pyrrrole	C ₄ H ₄ NH	100%	n	n	+	n	+	-	-	-	+	+	2
Roman Vitriol => Copper Sulphate													
Salicylic Acid	HOC ₆ H ₄ COOH	s	+	+	+	+	+	+	+	+	+	+/o	1
Salmiac => Ammonium Chloride													
Saltpeter => Potassium Nitrate													
Silic Acid	SiO ₂ * x H ₂ O	s	+	+	+	+	+	+	+	+	+	+	1
Silver Bromide	AgBr	s	+	+	+	+	+/o	+	+	+	+	+	1
Silver Chloride	AgCl	s	+	+	+	+	-	+	+	+	+	+/o	1
Silver Nitrate	AgNO ₃	s	+	+	+	+	+	+	+	+	+	+/o	3
Slaked Lime => Calcium Hydroxide													
Soda => Sodium Carbonate													
Sodium Acetate	NaCH ₃ COO	s	+	+	+	+	+	+	+	+	+	+	1
Sodium Benzoate	C ₆ H ₅ COONa	s	+	+	+	+	+	+	+	+	+	+	1
Sodium Bicarbonate	NaHCO ₃	s	+	+	+	+	+	+	+	+	+	+	1
Sodium Bisulphate	NaHSO ₄	s	+	+	+	+	+	+	+	+	+	+	1
Sodium Bisulphite	NaHSO ₃	s	+	+	+	+	+	+	+	+	+	+	1
Sodium Borate	NaBO ₂	s	+	+	+	+	+	+	+	+	+	+	1
Sodium Bromate	NaBrO ₃	s	+	+	+	+	+	+	+	+	+	+	3
Sodium Bromide	NaBr	s	+	+	+	+	+	+	+	+	+	+	1
Sodium Carbonate	Na ₂ CO ₃	s	+	+	+	+	+/o	+	+	+	+	+	1
Sodium Chlorate	NaClO ₃	s	+	+	+	+	+	+	+	+	+	+	2
Sodium Chloride	NaCl	s	+	+	+	+	-	+	+	+	+	+	1
Sodium Chlorite	NaClO ₂	24%	+	+	+	+	10%	+	+	+	+	10%	2
Sodium Chromate	Na ₂ CrO ₄	s	+	+	+	+	+	+	+	+	+	+	3
Sodium Cyanide	NaCN	s	+	+	+	+	+	+	+	+	+	+	3
Sodium Dichromate	Na ₂ Cr ₂ O ₇	s	+	+	+	+	+	+	+	+	+	+	3
Sodium Dithionite	Na ₂ S ₂ O ₄	s	+	10%	10%	+	+	n	n	+	10%	+/o	1
Sodium Fluoride	NaF	s	+	+	+	+	10%	+	+	+	+	+	1
Sodium Hydrogen Sulphate => Sodium Bisulphate													
Sodium Hydroxide	NaOH	50%	+	+	+	+	+ (60%/ 25 °C)	-	+	30%	+	+	1
Sodium Hypochlorite	NaOCl + NaCl	12%	+	+	o	+	-	+	+	+	o	> 10%	2
Sodium Iodide	NaI	s	+	+	+	+	+	+	+	+	+	+	1
Sodium Metaphosphate	(NaPO ₃) _n	s	+	+	+	+	+	+	+	+	+	+	1
Sodium Nitrate	NaNO ₃	s	+	+	+	+	+	+	+	+	+	+	1
Sodium Nitrite	NaNO ₂	s	+	+	+	+	+	+	+	+	+	+	2
Sodium Oxalate	Na ₂ C ₂ O ₄	s	+	+	+	+	+	+	+	+	+	+	1



ProMinent® Chemical Resistance List

Chemical	Formula	Conc	PMMA	PVC	PP	PVDF	1.4404	FKM	EPDM	PharMed®	PE	2.4819	WPC
Sodium Perborate	NaBO ₂ *H ₂ O ₂	s	+	+/o	+	+	+	+	+	+	+	+/o	1
Sodium Perchlorate	NaClO ₄	s	+	+	+	+	10%	+	+	+	+	10%	1
Sodium Peroxide	Na ₂ O ₂	s	+	+	+	+	+	+	+	n	-	+	1
Sodium Persulphate	Na ₂ S ₂ O ₈	s	n	+	+	+	+	+	+	+	+	+	1
Sodium Pyrosulphite	Na ₂ S ₂ O ₅	s	+	+	+	+	+	n	n	+	+	+	1
Sodium Salicylate	C ₆ H ₄ (OH)COONa	s	+	+/o	+	+	+	+	+	+	+	+	1
Sodium Silicate	Na ₂ SiO ₃	s	+	+	+	+	+	+	+	+	+	+	1
Sodium Sulphate	Na ₂ SO ₄	s	+	+	+	+	+	+	+	+	+	+	1
Sodium Sulphide	Na ₂ S	s	+	+	+	+	+	+	+	+	+	+	2
Sodium Sulphite	Na ₂ SO ₃	s	+	+	+	+	50%	+	+	+	+	50%	1
Sodium Tetraborate	Na ₂ B ₄ O ₇ * 10 H ₂ O	s	+	+	+	+	+	+	+	+	+	+	1
Sodium Thiosulphate	Na ₂ S ₂ O ₃	s	+	+	+	+	25%	+	+	+	+	25%	1
Sodium Tripolyphosphate	Na ₅ P ₃ O ₁₀	s	+	+	+	+	+	+/o	+	+	+	+	1
Starch	(C ₆ H ₁₀ O ₅) _n	s	+	+	+	+	+	+	n	+	+	+	1
Starch Gum		s	+	+	+	+	+	+	+	+	+	+	1
Styrene	C ₆ H ₅ CHCH ₂	100%	-	-	o	+	+	o	-	-	o	+	2
Sublimate => Mercury-II-Chloride													
Succinic Acid	C ₄ H ₆ O ₄	s	+	+	+	+	+	+	+	+	+	+	1
Sugar Syrup		s	+	+	+	+	+	+	+	+	+	+	1
Sulphur Chloride => Disulphur Dichloride													
Sulphuric Acid	H ₂ SO ₄	98%	30%	50%	85%	+	20%	+	+	30%	80%	+	1
Sulphuric Acid, fuming --> Oleum													
Sulphurous Acid	H ₂ SO ₃	s	+	+	+	+	10%	+	+	+	+	+	(1)
Sulphuryl Chloride	SO ₂ Cl ₂	100%	-	-	-	o	n	+	o	-	-	n	1
Tannic Acid	C ₇₆ H ₅₂ O ₄₆	50%	+	+	+	+	+	+	+	+	+	+	1
Tartaric Acid	C ₄ H ₆ O ₆	s	50%	+	+	+	+	+	+/o	+	+	+	1
Tetrachloro Ethane	C ₂ H ₂ Cl ₄	100%	-	-	o	+	+	o	-	o	o	+	3
Tetrachloro Ethylene	C ₂ Cl ₄	100%	-	-	o	+	+	o	-	o	o	+	3
Tetrachloromethane => Carbon Tetrachloride													
Tetrahydro Furane	C ₄ H ₈ O	100%	-	-	o	-	+	-	-	-	o	+	1
Tetrahydro Naphthalene	C ₁₀ H ₁₂	100%	-	-	-	+	+	+	-	-	o	+	3
Tetralin => Tetrahydro Naphthalene													
THF => Tetrahydrofuran													
Thionyl Chloride	SOCl ₂	100%	-	-	-	+	n	+	+	+	-	n	1
Thiophene	C ₄ H ₄ S	100%	n	-	o	n	+	-	-	-	o	+	3
Tin-II-Chloride	SnCl ₂	s	+	o	+	+	-	+	+	+	+	+/o	1
Tin-II-Sulphate	SnSO ₄	s	n	+	+	+	+	+	+	+	+	+/o	(1)
Tin-IV-Chloride	SnCl ₄	s	n	+	+	+	-	+	+	+	+	+	1
Titanium Tetrachloride	TiCl ₄	100%	n	n	n	+	n	o	-	n	n	n	1
Toluene	C ₆ H ₅ CH ₃	100%	-	-	o	+	+	o	-	-	o	+	2
Toluene Diisocyanate	C ₇ H ₃ (NCO) ₂	100%	n	n	+	+	+	-	+/o	n	+	+	2
Tributyl Phosphate	(C ₄ H ₉) ₃ PO ₄	100%	n	-	+	+	+	-	+	+	+	+	1
Trichloro Ethane	CCl ₃ CH ₃	100%	-	-	o	+	+	+	-	o	o	+	3
Trichloro Ethylene	C ₂ HCl ₃	100%	-	-	o	+	+/o	o	-	o	o	+	3
Trichloro Methane => Chloroform													
Trichloroacetaldehyde Hydrate	CCl ₃ CH(OH) ₂	s	-	-	o	-	+	o	o	n	+	+	2
Trichloroacetic Acid	CCl ₃ COOH	50%	-	+	+	+	-	-	o	+/o	+	+	1
Tricresyl Phosphate	(C ₇ H ₇) ₃ PO ₄	90%	-	-	+	n	+	o	+	+	+	+	2
Triethanol Amine	N(C ₂ H ₄ OH) ₃	100%	+	o	+	n	+	-	+/o	o	+	+	1
Trilene => Trichloro Ethane													
Trioctyl Phosphate	(C ₈ H ₁₇) ₃ PO ₄	100%	n	-	+	+	+	o	+	+	+	+	2
Trisodium Phosphate	Na ₃ PO ₄	s	+	+	+	+	+	+	+	+	+	+	1
Urea	CO(NH ₂) ₂	s	+	+/o	+	+	+	+	+	20%	+	+	1
Vinyl Acetate	CH ₂ =CHOOCC ₃ H ₇	100%	-	-	+	+	+	n	n	+/o	+	+	2
Water Glass => Sodium Silicate													
Xylene	C ₆ H ₄ (CH ₃) ₂	100%	-	-	-	+	+	o	-	-	o	+	2
Zinc Acetate	(CH ₃ COO) ₂ Zn	s	+	+	+	+	+	-	+	+	+	+	1
Zinc Chloride	ZnCl ₂	s	+	+	+	+	-	+	+	+	+	n	1
Zinc Sulphate	ZnSO ₄	s	+	+	+	+	+	+	+	+	+	+/o	1

1) Chlorine dioxide is capable of penetrating through PVDF without destroying it. This can lead to damage to PVDF-coated parts.



ProMinent® Chemical Resistance List

Overview of the Resistance of Soft PVC Hoses (Guttasyn®) to the Most Common Chemicals

This data applies to standard conditions (20 °C, 1013 mbar).

+	=	resistant
o	=	conditionally resistant
-	=	not resistant

The data is taken from relevant manufacturers' literature and supplemented by our own tests and experience. As the resistance of a material also depends on other factors, especially pressure and operating conditions etc, this list should merely be regarded as an initial guide and does not claim to offer any guarantees. Take into consideration the fact that conventional dosing agents are largely compounds, the corrosiveness of which cannot simply be calculated by adding together the corrosiveness of each individual component. In cases such as these the material compatibility data produced by the chemical manufacturer must be read as a matter of priority when selecting a material. Safety data sheets do not provide this information and cannot therefore replace application-specific documentation.

Corrosive agent	Concentration in %	Evaluation
Acetone	all	-
Acetylene tetrabromide	100	-
Alums of all kinds, aqueous	all	+
Aluminium salts, aqueous	all	+
Ammonium, aqueous	15	-
Ammonium, aqueous	saturated	-
Ammonium salts	all	+
Aniline	100	-
Benzene	100	-
Bisulphite, aqueous	40	+
Borax solution	all	+
Boric acid, aqueous	10	+
Bromine, vaporous and liquid		-
Hydrogen bromide	10	+
Butanol	100	+
Butyric acid, aqueous	20	+
Butyric acid, aqueous	conc.	-
Butyl acetate	100	-
Calcium chloride, aqueous	all	+
Chlorinated hydrocarbons	all	-
Chrome-alum, aqueous	all	+
Chromic acid, aqueous	50	-
Dextrin, aqueous	saturated	+
Diesel oils, compressed oils	100	o
Diethyl ether	100	-
Fertilizing manure salt, aqueous	all	+
Ferric chloride, aqueous	all	+
Glacial acetic acid	100	-
Acetic ester	100	-
Acetic acid, aqueous	10	+
Acetic acid	50	o
Acetic acid (wine vinegar)		o
Acetic acid anhydride	100	-
Ethanol	96	-
Ethyl acetate	100	-
Ethylene glycol	30	+
Formaldehyde, aqueous	30	o
Difluorodichloromethane	100	-
Glycerol	100	-
Glucose, aqueous	saturated	+
Halogens	all	-
Urea, aqueous	all	+
Caustic potash	15	+
Potassium bichromate, aqueous	saturated	+
Potassium persulphate, aqueous	saturated	+



ProMinent® Chemical Resistance List

Corrosive agent	Concentration in %	Evaluation
Creosote		-
Sodium chloride, aqueous	all	+
Carbonic acid	all	+
Copper sulphate, aqueous	all	+
Magnesium salts, aqueous	all	+
Methyl alcohol	100	+
Methylene chloride	100	-
Sodium hypochlorite	15	+
Sodium salts => sodium chloride		
Sodium hydroxide	aqueous	+
Oils => fats, diesel oil, Lubricating oil and similar		
Perchloric acid	all	o
Phenol, aqueous	all	o
Phosphoric acid, aqueous	100	-
Nitric acid, aqueous	25	+
Hydrochloric acid	15	+
Sulphur dioxide, gaseous	all	+
Carbon disulphide	100	-
Sulphuric acid	30	+
Hydrogen sulphide, gaseous	100	-
Silver nitrate	10	+
Tetrachloromethane	100	-
Ink		+
Toluene	100	-
Trichloroethylene	100	-
Hydrogen peroxide	to 10	+
Xylene	100	-
Zinc salts	all	+



Product catalogue 2018

Order your personal copy.
How you want it, when you want it.

Groundbreaking diversity: ProMinent 2018.

Our product catalogue is available in four individual volumes. We are offering you the following options so that you can request your catalogue of choice.



Metering pumps, components
and metering systems



Motor-driven and process metering
pumps for all capacity ranges



Measuring, control and
sensor technology



Water treatment and
water disinfection

You can find the ProMinent app for iPads in the iTunes App Store.
www.prominent.com/app



You can find our individual catalogue volumes for download or online browsing at
www.prominent.com/en/product-catalogue
Or request your own printed copy directly from us at
www.prominent.com/en/catalogue-request

Do you need an overview of our entire product range?
Then we would recommend our product overview.
www.prominent.com/en/productoverview